

TOSHIBA

6F3B0253

UM-TS01***-E031

PROGRAMMABLE CONTROLLER

PROSEC **T1-16S**

USER'S MANUAL
– Basic Hardware and Function –

TOSHIBA CORPORATION

Important Information

Misuse of this equipment can result in property damage or human injury. Because controlled system applications vary widely, you should satisfy yourself as to the acceptability of this equipment for your intended purpose. In no event will Toshiba Corporation be responsible or liable for either indirect or consequential damage or injury that may result from the use of this equipment.

No patent liability is assumed by Toshiba Corporation with respect to use of information, illustrations, circuits, equipment or examples of application in this publication.

Toshiba Corporation reserves the right to make changes and improvements to this publication and/or related products at any time without notice. No obligation shall be incurred other than as noted in this publication.

This publication is copyrighted and contains proprietary material. No part of this book may be reproduced, stored in a retrieval system, or transmitted, in any form or by any means — electrical, mechanical, photocopying, recording, or otherwise — without obtaining prior written permission from Toshiba Corporation.

© TOSHIBA Corporation 2001. All rights reserved

IBM is a registered trademark of International Business Machines Corporation.
MS-DOS and Windows are registered trademarks of Microsoft Corporation.

Publication number: UM-TS01***-E031
1st edition April 2001, 2nd edition November 2001

CE Marking

The Programmable Controller PROSEC T1-16S (hereafter called T1-16S) complies with the requirements of the EMC Directive 89/336/EEC and Low Voltage Directive 72/23/EEC under the condition of use according to the instructions described in this manual.

The contents of the conformity are shown below.

Application of Council Directive	EMC : 89/336/EEC (as amended by 91/263/EEC and 92/31/EEC) LVD : 72/23/EEC (as amended by 93/68/EEC)
Manufacture's Name	: Toshiba Corporation, Fuchu Operations-Social Infrastructure Systems
Address	: 1, Toshiba-Cho Fuchu-shi TOKYO 183-8511 Japan
<i>declares, that the product</i>	
Product Name	: Programmable Controller , T1-16S
Model Number	: TDR116S6S, TDR116S6C TDR116S3S, TDR116S3C
<i>conforms to the following Product Specifications:</i>	
EMC	
Radiated Interference	: EN 55011 Group 1 Class A
Mains Interference	: EN 55011 Group 1 Class A
Radiated Susceptibility	: ENV50140
Conducted RFI Susceptibility	: ENV50141, IEC100-4-6.
Electrostatic Discharge	: IEC1000-4-2
Electrical Fast Transient	: IEC1000-4-4
LVD	: EN61131-2:1995 3.10 Dielectric Properties 4. Mechanical Requirements
Supplementary information	:
(1) Included Handy Programmer THP911A*S.	
(2) Included each type of associated input/output unit in a typical configuration.	
(3) Product must be installed in accordance with manufacturers instructions	

UL/c-UL Listing

The Programmable Controller PROSEC T1-16S (hereafter called T1-16S) is UL/c-UL listed as shown below.

UL and c-UL Listing

File Number : E95637
Product Name : Programmable Controller , T1-16S
Product Covered : Main Unit
 TDR116S6S, TDR116S6C,
 TDR116S3S, TDR116S3C
 I/O module
 TD1116M*S, TDD116M*S, TDO116M*S,
 TAD121M*S, TAD131M*S, TDA121M*S, TDA131M*S,
 TFR112M*S
 Peripherals
 TRM102**S, TCU111**S, THP911A*S

UL and c-UL Listing For Use in Hazardous Locations

File Number : E184034
Product Name : Programmable Controller , T1-16S
Product Covered : Main Unit
 TDR116S6S, TDR116S6C
Locations Class : Class I, Division 2, Groups A, B, C, D

Important Notice :

1. THIS EQUIPMENT IS SUITABLE FOR USE IN CLASS I, DIVISION 2, GROUPS A, B, C, D OR NON-HAZARDOUS LOCATIONS ONLY.
2. WARNING - EXPLOSION HAZARD - SUBSTITUTION OF COMPONENTS MAY IMPAIR SUITABILITY FOR CLASS I, DIVISION 2.
3. WARNING - EXPLOSION HAZARD - DO NOT DISCONNECT EQUIPMENT UNLESS POWER HAS BEEN SWITCHED OFF OR THE AREA IS KNOWN TO BE NON-HAZARDOUS.

Safety Precautions

This manual is prepared for users of Toshiba's Programmable Controller T1-16S. Read this manual thoroughly before using the T1-16S. Also, keep this manual and related manuals so that you can read them anytime while the T1-16S is in operation.

General Information

1. The T1-16S has been designed and manufactured for use in an industrial environment. However, the T1-16S is not intended to be used for systems which may endanger human life. Consult Toshiba if you intend to use the T1-16S for a special application, such as transportation machines, medical apparatus, aviation and space systems, nuclear controls, submarine systems, etc.
2. The T1-16S has been manufactured under strict quality control. However, to keep safety of overall automated system, fail-safe systems should be considered outside the T1-16S.
3. In installation, wiring, operation and maintenance of the T1-16S, it is assumed that the users have general knowledge of industrial electric control systems. If this product is handled or operated improperly, electrical shock, fire or damage to this product could result.
4. This manual has been written for users who are familiar with Programmable Controllers and industrial control equipment. Contact Toshiba if you have any questions about this manual.
5. Sample programs and circuits described in this manual are provided for explaining the operations and applications of the T1-16S. You should test completely if you use them as a part of your application system.

Hazard Classifications

In this manual, the following two hazard classifications are used to explain the safety precautions.

 **WARNING** Indicates a potentially hazardous situation which, if not avoided, could result in death or serious injury.

 **CAUTION** Indicates a potentially hazardous situation which, if not avoided, may result in minor or moderate injury. It may also be used to alert against unsafe practices.

Even a precaution is classified as CAUTION, it may cause serious results depending on the situation. Observe all the safety precautions described on this manual.

Safety Precautions

Installation:

 CAUTION

1. Excess temperature, humidity, vibration, shocks, or dusty and corrosive gas environment can cause electrical shock, fire or malfunction. Install and use the T1-16S and related equipment in the environment described in this manual.
2. Improper installation directions or insufficient installation can cause fire or the units to drop. Install the T1-16S and related equipment in accordance with the instructions described in this manual.
3. Turn off power before installing or removing any units, modules, racks, terminal blocks or battery. Failure to do so can cause electrical shock or damage to the T1-16S and related equipment.
4. Entering wire scraps or other foreign debris into to the T1-16S and related equipment can cause fire or malfunction. Pay attention to prevent entering them into the T1-16S and related equipment during installation and wiring.
5. Turn off power immediately if the T1-16S or related equipment is emitting smoke or odor. Operation under such situation can cause fire or electrical shock. Also unauthorized repairing will cause fire or serious accidents. Do not attempt to repair. Contact Toshiba for repairing.

Wiring:

 CAUTION

1. Turn off power before wiring to minimize the risk of electrical shock.
2. Exposed conductive parts of wire can cause electrical shock. Use crimp-style terminals with insulating sheath or insulating tape to cover the conductive parts. Also close the terminal covers securely on the terminal blocks when wiring has been completed.
3. Operation without grounding may cause electrical shock or malfunction. Connect the ground terminal on the T1-16S to the system ground.
4. Applying excess power voltage to the T1-16S can cause explosion or fire. Apply power of the specified ratings described in the manual.
5. Improper wiring can cause fire, electrical shock or malfunction. Observe local regulations on wiring and grounding.

Safety Precautions

Operation:

 **WARNING**

1. Configure emergency stop and safety interlocking circuits outside the T1-16S. Otherwise, malfunction of the T1-16S can cause injury or serious accidents.

 **CAUTION**

2. Operate the T1-16S and the related modules with closing the terminal covers. Keep hands away from terminals while power on, to avoid the risk of electrical shock.
3. When you attempt to perform force outputs, RUN/HALT controls, etc. during operation, carefully check for safety.
4. Turn on power to the T1-16S before turning on power to the loads. Failure to do so may cause unexpected behavior of the loads.
5. Do not use any modules of the T1-16S for the purpose other than specified. This can cause electrical shock or injury.
6. Do not modify the T1-16S and related equipment in hardware nor software. This can cause fire, electrical shock or injury.
7. Configure the external circuit so that the external 24 Vdc power required for transistor output circuits and power to the loads are switched on/off simultaneously. Also, turn off power to the loads before turning off power to the T1-16S.
8. Install fuses appropriate to the load current in the external circuits for the outputs. Failure to do so can cause fire in case of load over-current.
9. Check for proper connections on wires, connectors and modules. Insufficient contact can cause malfunction or damage to the T1-16S and related equipment.

Safety Precautions

Maintenance: **CAUTION**

1. Turn off power before removing or replacing units, modules, terminal blocks or wires. Failure to do so can cause electrical shock or damage to the T1-16S and related equipment.
2. When you remove both input and output terminal blocks with wires for maintenance purpose, pay attention to prevent inserting them upside down.
3. Touch a grounded metal part to discharge the static electricity on your body before touching the equipment.
4. Otherwise, charged static electricity on your body can cause malfunction or failure.
5. Do not disassemble the T1-16S because there are hazardous voltage parts inside.
6. Perform daily checks, periodical checks and cleaning to maintain the system in normal condition and to prevent unnecessary troubles.
7. Check by referring “Troubleshooting” section of this manual when operating improperly. Contact Toshiba for repairing if the T1-16S or related equipment is failed. Toshiba will not guarantee proper operation nor safety for unauthorized repairing.
8. The contact reliability of the output relays will reduce if the switching exceeds the specified life. Replace the unit or module if exceeded.
9. The battery used in T1-16S may present a risk of fire or chemical burn if mistreated. Do not recharge, disassemble, heat above 100°C (212°F), or incinerate.
10. Replace battery with CR2032 only. Use of another battery may present a risk of fire or explosion.
11. Dispose of used battery promptly. Keep away from children. Do not disassemble and do not dispose of in fire.

Safety Precautions

Safety Label

The safety label as shown on the right is attached to the power terminal of the T1-16S.

Remove the mount paper before wiring.

Peel off the label from the mount paper and stick it near the power terminals where it can be readily seen.

Contact Toshiba if the label is damaged.

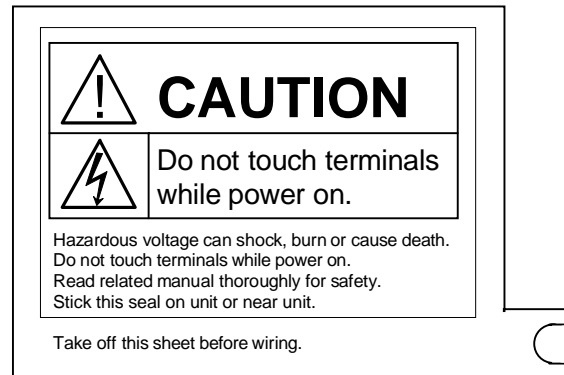

About This Manual

About This Manual

This manual has been prepared for first-time users of Toshiba's Programmable Controller T1-16S to enable a full understanding of the configuration of the equipment, and to enable the user to obtain the maximum benefits of the equipment.

This manual introduces the T1-16S, and explains the system configuration, specifications, installation and wiring for T1-16S's basic hardware. This manual provides the information for designing T1-16S user program, such as the internal operation, memory configuration, I/O allocation and programming instructions. Information for maintenance and troubleshooting are also provided in this manual.

The T1-16S's computer link function and T1-16S's multi-purpose communication functions are covered by the separate manual. Read the T1-16S User's Manual - Communication Function - for details.

Inside This Manual

This manual consists of 10 main sections and an appendix.

Section 1 outlines the T1-16S configuration. To fully understand the T1-16S, it is important to read this section carefully. Sections 2, to 4 describe the hardware used in designing external circuits and panels. Sections 5 to 7 are mainly concerned with software. Section 8 explains the T1-16S's special I/O functions. Sections 9 and 10 describe the maintenance procedure for the T1-16S, to ensure safe operation and long service life.

Related Manuals

The following related manuals are available for T1-16S. Besides this manual, read the following manuals for your better understanding.

T1-16S User's Manual

- | | |
|---|-----------------|
| - Basic Hardware and Function - (this manual) | UM-TS01***-E031 |
| - I/O Modules - | UM-TS01***-E034 |
| - Communication Function - | UM-TS01***-E033 |

T-Series Handy Programmer (HP911) Operation Manual	UM-TS03***-E025
--	-----------------

T-Series Program Development System (T-PDS) User's Manual	UM-TS03***-E045
---	-----------------

About This Manual

Terminology

The following is a list of abbreviations and acronyms used in this manual.

μs	microsecond
ASCII	American Standard Code For Information Interchange
AWG	American Wire Gage
BCC	Block Check Code
CCW	Counter-Clockwise
CPU	Central Processing Unit
CW	Clockwise
EEPROM	Electrically Erasable Programmable Read Only Memory
H	hexadecimal (when it appears in front of an alphanumeric string)
I/O	Input/Output
LED	Light Emitting Diode
LSB	Least Significant Bit
ms	millisecond
MSB	Most Significant Bit
PWM	Pulse Width Modulation
RAM	Random Access Memory
ROM	Read Only Memory
Vac	AC voltage
Vdc	DC voltage

Contents

Contents

Safety Precautions	3
About This Manual	8
1. System Configuration	13
1.1 Introducing the T1-16S	14
1.2 Features	16
1.3 System configuration	19
1.4 I/O expansion	20
1.5 Components	21
1.5.1 Basic unit	21
1.5.2 I/O modules	25
1.5.3 Options	26
1.6 Programmer port function	27
1.7 RS-485 port communication function	28
1.8 Real-time data link system	32
1.9 Peripheral tools	33
2. Specifications	37
2.1 General specifications	38
2.2 Functional specifications	40
2.3 I/O specifications	42
2.4 External dimensions	46
3. I/O Application Precautions	47
3.1 Application precautions for input signals	48
3.2 Application precautions for output signals	50
4. Installation and Wiring	53
4.1 Environmental conditions	54
4.2 Installing the unit	55
4.3 Wiring terminals	57
4.4 Grounding	58
4.5 Power supply wiring	59
4.6 I/O wiring	61

Contents

5.	Operating System Overview	63
5.1	Operation modes	64
5.2	About the built-in EEPROM	66
5.3	Scanning	69
6.	Programming Information	73
6.1	Devices and registers	74
6.2	Index modification	86
6.3	Real-time clock/calendar	88
6.4	I/O allocation	89
6.5	T1-16S memory mode setting.....	91
6.6	User program configuration	92
6.6.1	Main program	94
6.6.2	Sub-program #1	95
6.6.3	Timer interrupt program	95
6.6.4	I/O interrupt programs	96
6.6.5	Subroutines	97
6.7	Programming language	98
6.8	Program execution sequence	99
6.9	On-line debug support functions	100
6.10	Password protection	103
7.	Instructions	105
7.1	List of instructions	106
7.2	Instruction specifications	116
8.	Special I/O Functions	255
8.1	Special I/O function overview	256
8.2	Variable input filter constant	260
8.3	High speed counter	261
8.3.1	Single phase up-counter	262
8.3.2	Single phase speed-counter	263
8.3.3	Quadrature bi-pulse counter	265
8.4	Interrupt input function	268
8.5	Analog setting function	270
8.6	Pulse output function	271
8.7	PWM output function	273
9.	Maintenance and Checks	275
9.1	Precautions during operation	276
9.2	Daily checks	277
9.3	Periodic checks	278
9.4	Maintenance parts	279
9.5	Battery	280

Contents

10.	Troubleshooting	281
10.1	Troubleshooting procedure	282
10.1.1	Power supply check	283
10.1.2	CPU check	284
10.1.3	Program check	284
10.1.4	Input check	285
10.1.5	Output check	286
10.1.6	Environmental problem	287
10.2	Self-diagnostic items	288
	Appendix	293
A.1	List of models and types	294
A.2	Instruction index	295

Section 1

System Configuration

- 1.1 *Introducing the T1-16S, 14*
- 1.2 *Features, 16*
- 1.3 *System configuration, 19*
- 1.4 *I/O expansion, 20*
- 1.5 *Components, 21*
- 1.6 *Computer link system, 27*
- 1.7 *T1-16S Communication function, 28*
- 1.8 *Real-time data link system, 32*
- 1.9 *Peripheral tools, 33*

1. System Configuration

1.1 Introducing the T1-16S

The T1-16 is compact, block style, high-performance programmable controller with a range of 16 to 144 input and output points.

The figure below shows the T1 Series line-up. The T1 Series consists of the total 16 types.

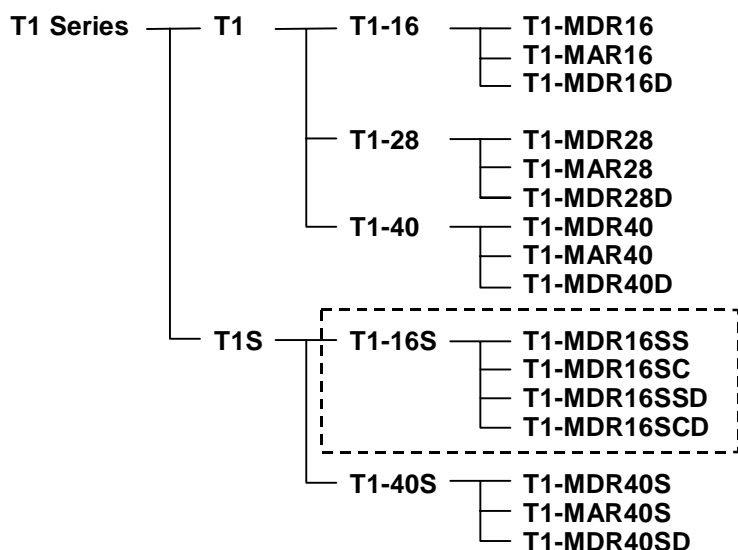

I/O points:

The T1 Series are available in five models, T1-16, T1-28, T1-40, T1-40S and T1-16S. Each model has the following I/O points.

	T1-16	T1-16S	T1-28	T1-40	T1-40S
Input	8 points		14 points	24 points	
Output	8 points (6 relay plus 2 slid-state)		14 points (12 relay plus 2 slid-state)	16 points (14 relay plus 2 solid-state)	
Expansion	No	Up to 8 I/O modules. Total up to 144 points.	No	2 option cards plus 1 expansion rack or unit. Total up to 382 points.	

The T1-16S can expand its I/O points by connecting I/O modules. Up to eight I/O modules can be connected. If eight 16-point I/O modules are connected to the T1-16S, it can control up to 144 points.

1. System Configuration

Memory capacity:

Program memory capacity of the T1 is 2 k steps. And that of the T1S is 8 k steps. Whole the program and a part of data registers are stored in built-in EEPROM.

	T1-16/28/40	T1-40S	T1-16S
Memory	RAM (for execution) and EEPROM (for back-up)		
Program capacity	2 k steps	8 k steps (4 k mode or 8 k mode)	
Data capacity	Auxiliary relay: 1024 points Timer: 64 points Counter: 64 points Data register: 1024 words	Auxiliary relay: 4096 points Timer: 256 points Counter: 256 points Data register: 4096 words	
EEPROM back-up	Program and leading 512 words of Data register	Program and the user specified range of Data register (0 to 2048 words)	
RAM back-up (at 25°C) (at 77°F)	Capacitor: 6 hours or more	Capacitor: 168 hours or more	Capacitor: 1 hour or more Battery: 2 years or more

Control functions:

In addition to the basic relay ladder functions, the T1/T1S provides functions such as data operations, arithmetic operations, various functions, etc. Furthermore, its high-speed counter functions, pulse output functions and data communication functions allow its application to a wide scope of control systems.

	T1-16/28/40	T1-40S	T1-16S
Language	Ladder diagram with function block		
Number of instructions	Basic: 17 types Function: 76 types	Basic: 21 types Function: 99 types	Basic: 21 types Function: 97 types
Subroutines	16 (nesting not allowed)	256 (up to 3 levels of nesting)	
Execution speed	1.4 μs/contact, 2.3 μs/coil, 4.2 μs/transfer, 6.5 μs/addition		
Real-time clock/calendar	No	Yes (year, month, day, week, hours, minutes, seconds)	
Communication	RS-232C (programmer port)	RS-232C (programmer port), RS-485 (multi-purpose)	

Construction:

The T1-16S is a compact, easy-handling block style programmable controller. The T1-16S has all of the features of a block style controller. In addition, the T1-16S has modular expandability. The T1-16S provides flexibility into the block style controller.

Series compatibility:

Programming instructions are upward compatible in the T-Series programmable controllers. The T1/T1S programs can be used for other models of the T-Series, T2, T2E, T2N, T3 and T3H. Peripheral tools can also be shared.

1. System Configuration

1.2 Features

I/O module support:

The T1-16S has an interface for connecting the I/O modules. Up to eight modules can be connected to the T1-16S.

By using the 16 points I/O module, the T1-16S can control up to 144 I/O points.

Built-in high-speed counter:

Two single-phase or one quadrature (2-phase) pulses can be counted. The acceptable pulse rate is up to 5 kHz. (DC input type only)

Built-in analog setting adjusters:

Two analog setting adjusters are provided on the T1-16S. This allows operators to adjust time or other control parameters easily using a screwdriver.

High speed processing:

Sophisticated machine control applications require high speed data manipulations. The T1-16S is designed to meet these requirements.

- 1.4 μ s per contact
- 2.3 μ s per coil
- 4.2 μ s per 16-bit transfer
- 6.5 μ s per 16-bit addition

The T1-16S also supports interrupt input function (DC input type only). This allows immediate operation independent of program scan.

High performance software:

The T1-16S offers 21 basic ladder instructions and 97 function instructions. Subroutines, Interrupt functions, Indirect addressing, For/Next loops, Pre-derivative real PID, etc. are standard on the T1-16S. These functions allow the T1-16S to be applied to the most demanding control applications.

Battery-less operation:

The T1-16S has a standard built-in EEPROM, permitting operation without need of a battery. Also, the variable data can be written into and/or read from the EEPROM, providing completely maintenance-free back-up operation.

This function is an important feature for OEMs, because it can eliminate the need for changing the battery every few years.

(Optional battery is also available to back-up real-time clock and retentive data)

1. System Configuration

Pulse output / PWM output:

One point of variable frequency pulses (max. 5 kHz) or variable duty pulses can be output. These functions can be used to drive a stepping motor or to simulate an analog output. (DC input type only)

Built-in computer link function:

The T1-16S's RS-232C programmer port can accept the computer link protocol (data read/write). This results in easy connection to a higher level computer, an operator interface unit, etc.

The parity setting of the programmer port can be selected either odd or none. The none parity mode is provided especially for telephone modem connection. Using modems, remote programming/monitoring is available.

Real-time control data link network:

By connecting the TOSLINE-F10 remote module (FR112M) to the T1 -16S, high-speed data link network can be established. In this network, upper T-series PLC model (T2/T2E/T2N or T3/T3H) works as master and up to 16 T1-16Ss can be connected as remote. Each T1-16S can exchange data with the master through 1 word input and 1 word output. The transmission speed can be selected either 750 kbps or 250 kbps.

Sampling trace function:

The sampling trace is the function to collect the user specified data every user specified timing (minimum every scan), and to display the collected data on the programmer screen in time chart and/or trend graph format. This function is useful for checking the input signals changing.

Password protection:

By registering your passwords, four levels of protection is available according to the security levels required for your application.

Level 4: Reading/writing program and writing data are prohibited

Level 3: Reading/writing program are prohibited

Level 2: Writing program is prohibited

Level 1: No protection (changing passwords is available only in this level)

Two points of solid-state output:

Each model of the T1-16S has two points of solid-state output (transistors for DC input type and triacs for AC input type). These solid-state outputs are suitable for frequent switching application.

1. System Configuration

DIN rail mounting:

The T1-16S is equipped with brackets for mounting on a standard 35 mm DIN rail. The T1-16S can be mounted on a DIN rail as well as screw mounting.

On-line program changes:

When the T1-16S's memory mode is set to 4 k steps mode, on-line (in RUN mode) program changes are available. Furthermore, program writing into the built-in EEPROM is also available in RUN mode. These functions are useful in program debugging stage.

Real-time clock/calendar function: (Enhanced model only)

The T1-16S has the real-time-clock/calendar function (year, month, day, day of the week, hours, minutes, seconds) that can be used for performing scheduled operations, data gathering with time stamps, etc. To back-up the real-time clock/calendar data, use of the optional battery is recommended.

RS-485 multi-purpose communication port: (Enhanced model only)

The T1-16S has an RS-485 multi-purpose communication port. Using this port, one of the following communication modes can be selected.

- **Computer link mode:** T-series computer link protocol can be used in this mode. Up to 32 T1-16Ss can be connected to a master computer. By using this mode, MMI/SCADA system can be easily configured.
- **Data link mode:** Two PLCs (any combination of T1S, T2E or T2N) can be directly linked together. This direct link is inexpensive, easily configured and requires no special programming.
- **Free ASCII mode:** User defined ASCII messages can be transmitted and received through this port. A terminal, printer, bar-code reader, or other serial ASCII device can be directly connected.
- **Inverter connection mode:** This mode is specially provided to communicate with Toshiba Inverters (ASDs) VF-A7/G7/S9 series. By using this function, the T1-16S can control and monitor the connected Inverters.

1. System Configuration

1.3 System configuration

The following figure shows the T1-16S system configuration.

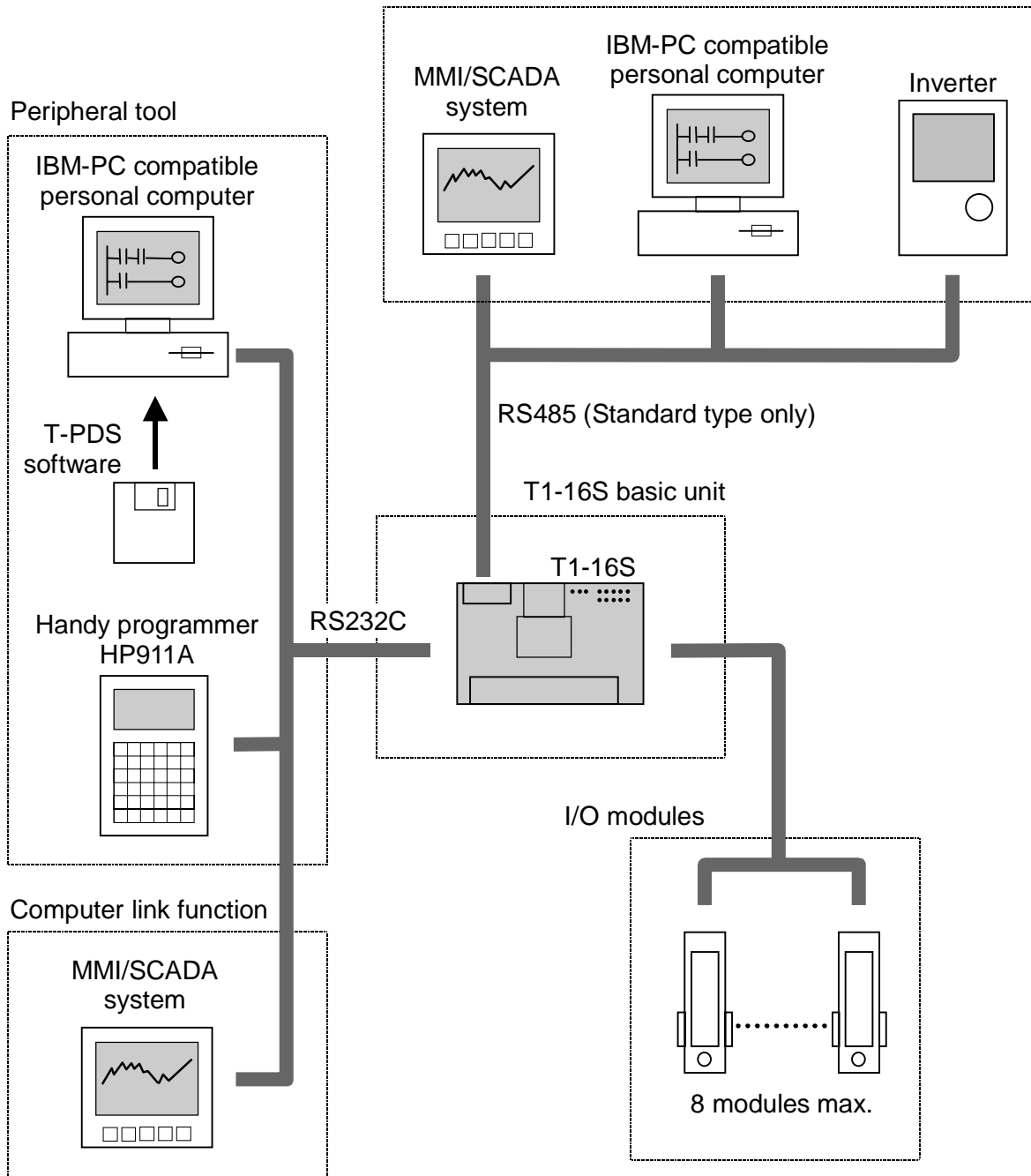

1. System Configuration

1.4 I/O expansion

The T1-16S provides I/O expandability by connecting the I/O modules. Up to eight I/O modules can be connected.

Available I/O modules

DI116M:	16 points DC input
DO116M:	16 points DC output
DD116M:	8 points DC input + 8 points DC output
RO108M:	8 points relay output
AD121M:	1 channel analog input (0 to 5V or 0 to 20mA)
AD131M:	1 channel analog input (-10 to +10V)
DA121M:	1 channel analog output (0 to 20mA)
DA131M:	1 channel analog output (-10 to +10V)
TC111M:	1 channel thermocouple input (type K, J, E, or $\pm 50\text{mV}$)
FR112M:	TOSLINE-F10 remote station

T1-16S maximum configuration

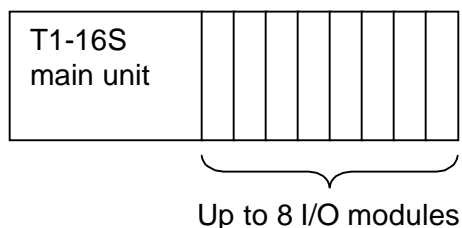

- NOTE**
- (1) The 5Vdc power to the I/O modules is supplied from the main unit. The main unit can supply maximum 1.5A of the 5Vdc power to the I/O modules. Check the current consumption of each I/O module used. Refer to section 2.1.
 - (2) The connecting order of the I/O modules is not restricted except TOSLINE-F10 remote station FR112M. When the FR112M is used, it must be the right end module.
 - (3) If more than 8 I/O modules are connected, the T1-16S cannot operate normally.

1. System Configuration

1.5 Components

1.5.1 Basic unit

The T1-16S is available in four types as shown in the following table.

Type	Link/ Calendar	Power supply	Input	Output
T1-MDR16SS (Enhanced model)	Yes	100-240 Vac, 50/60 Hz	8 points - 24 Vdc	6 points - relay, 2 points - transistor
T1-MDR16SC (Standard model)	No			
T1-MDR16SSD (Enhanced model)	Yes	24 Vdc		
T1-MDR16SCD (Standard model)	No			

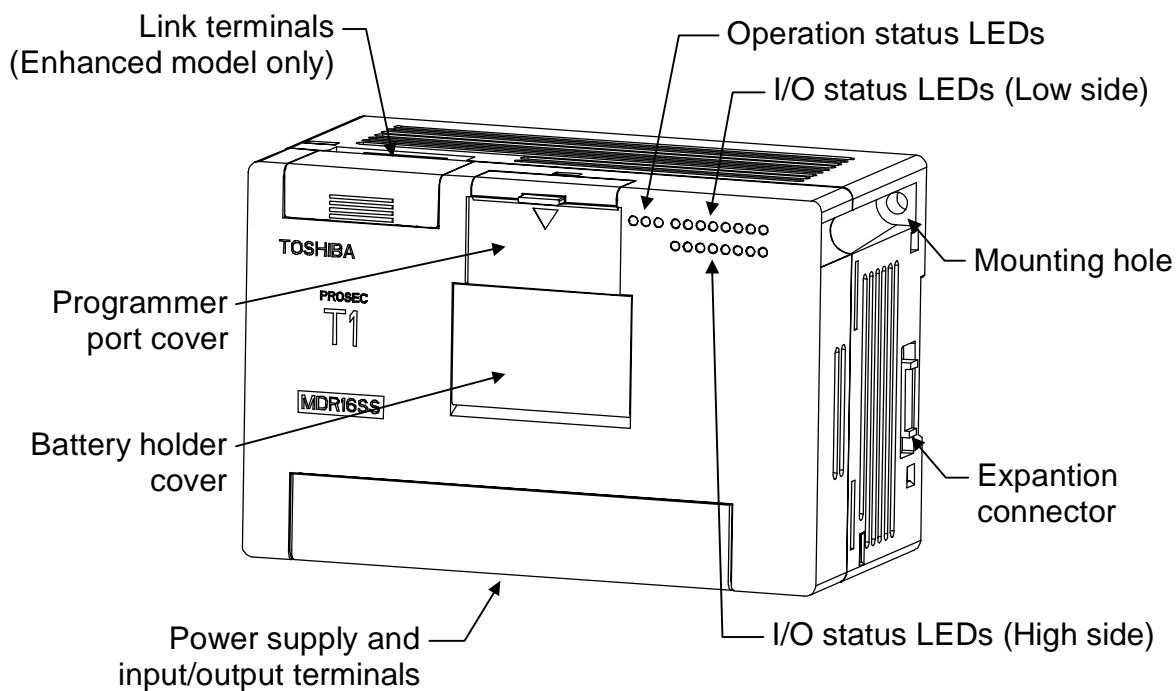

1. System Configuration

◆ Behind the programmer port cover

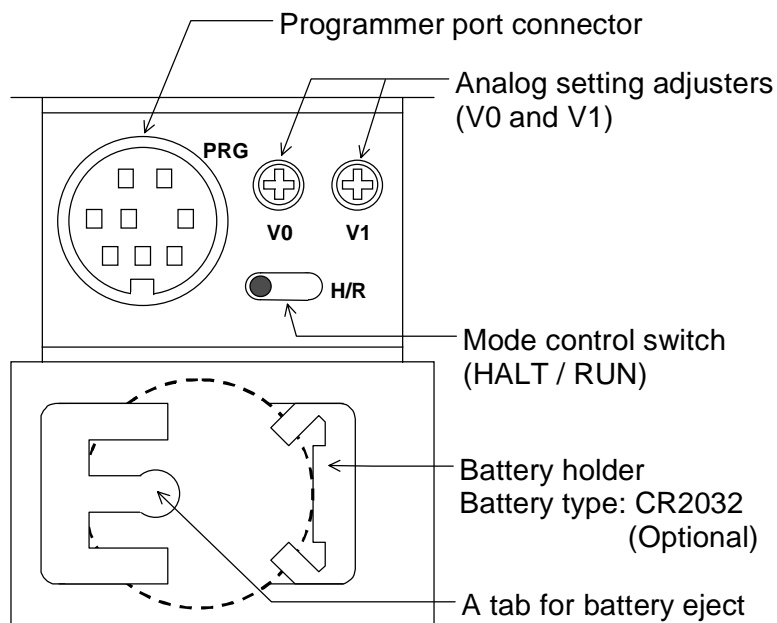
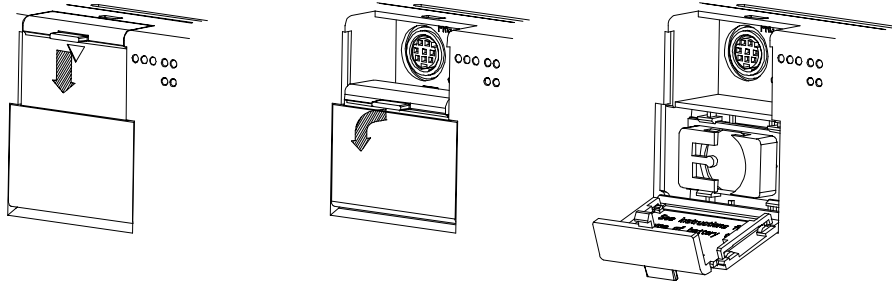

Power supply terminals:

Connect the power cable and grounding wire. The terminal screw size is M3. See sections 4.4 and 4.5 for wiring.

Input terminals:

Connect input signal wires. The terminal screw size is M3. See section 2.4 for details.

Output terminals:

Connect output signal wires. The terminal screw size is M3. See section 2.4 for details.

1. System Configuration

I/O status LEDs:

Indicates the ON/OFF status of each I/O signal. (color: red)

SW54 setting value	I/O intending for an indication	Note
0 (default)	Basic unit (L: X000-007, H: Y020-027)	It indicates these at the time of only RUN mode.
1	I/O module slot 0	
2	I/O module slot 1	
3	I/O module slot 2	
4	I/O module slot 3	
5	I/O module slot 4	
6	I/O module slot 5	
7	I/O module slot 6	
8	I/O module slot 7	
9	TOSLINE-F10 (FR112M), Low 1 word	
10	TOSLINE-F10 (FR112M), High 1 word	
Others	Basic unit (L: X000-007, H: Y020-027)	

Operation status LEDs:

Indicates the operation status of the T1-16S.

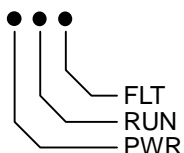

PWR (Power) (green)	Lit	Internal 5 Vdc power is normal.
	Not lit	Internal 5 Vdc power is not normal.
RUN (green)	Lit	RUN mode (in operation)
	Blinking	HOLD mode
	Not lit	HALT mode or ERROR mode
FLT (Fault) (red)	Lit	ERROR mode
	Blinking	Hardware error (programmer cannot be connected)
	Not lit	Normal

Mode control switch:

Controls the operation modes of the T1-16S.

H (HALT)	When the switch is turned to H (HALT) side, the T1-16S stops program execution (HALT mode). In this position, RUN/HALT command from the programmer is disabled.
R (RUN)	When the switch is turned to R (RUN) side, the T1-16S starts program execution. This is the position during normal operation. In this position, RUN/HALT command from the programmer is also available.

1. System Configuration

Analog setting adjusters:

Two analog setting adjusters are provided. The V0 value is stored in SW30 and the V1 value is stored in SW31. The converted value range is 0 to 1000. Refer to section 8.5 for details of the analog setting function.

Programmer port connector:

Used to connect the programmer cable. The interface is RS-232C. This port can also be used for the computer link function. Refer to section 1.6 for more information about the computer link function.

Expansion connector:

Used to connect the I/O module.

RS-485 port (Enhanced model only):

Used to connect a computer (SCADA system), operator interface unit, other T1-16S, or many kinds of serial ASCII devices including Toshiba's Inverter through RS-485 interface. Refer to section 1.7 for more information about the T1-16S's RS-485 multi-purpose communication functions.

Mounting holes:

Used to fix the T1-16S on a mounting frame by screws. The mounting holes are provided at two opposite corners.

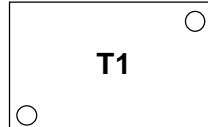

Use two M4 screws for mounting. See section 4.2 for installing the unit.

DIN rail bracket:

The DIN rail bracket is provided at the rear for mounting the T1-16S on a 35 mm DIN rail. See section 4.2 for installing the unit.

1. System Configuration

1.5.2 I/O modules

The T1-16S can connect up to eight I/O modules.

The following 10 types of the I/O modules are available.

For specification details of the I/O modules, refer to the separate manual “T1-16S User’s Manual – I/O Modules –”.

Type	Description	Power supply
DI116M	16 points input, 24Vdc – 5mA	Supplied from the basic unit (5 Vdc)
DO116M	16 points output, 24Vdc – 100mA	
DD116M	8 points input, 24Vdc - 5mA + 8 points output, 24Vdc – 100mA	
RO108M	8 points relay output, 24Vdc/240Vac - 1A	
AD121M	1 channel analog input, 0 to 5V / 0 to 20mA	
AD131M	1 channel analog input, $\pm 10V$	
DA121M	1 channel analog output, 0 to 20mA	
DA131M	1 channel analog output, $\pm 10V$	
TC111M	1 channel thermo-couple input	
FR112M	TOSLINE-F10 remote station, 1 word input + 1 word output	

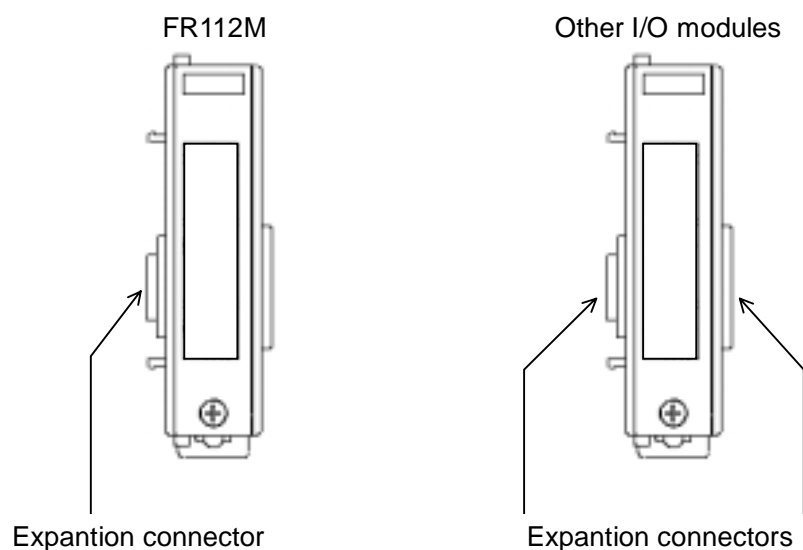

- (1) If more than 8 I/O modules are connected, T1-16S cannot operate normally.
 (2) The TOSLINE-F10 remote station module (FR112M) must be connected at the right end. Two or more FR112Ms cannot be used together.

1. System Configuration

1.5.3 Options

The following optional items are available.

Item	Type	Description	
Cable for programming tool	CJ105	For T-PDS, 5 m length	
Programmer port connector	PT16S	For RS-232C computer link, with 2 m cable	
Option card I/O connector	PT15S	Cable side connector for DI116M, DO116M, or DD116M	Soldering type
	PT15F		Flat cable type
Back-up battery	CR2032	For memory back up. (Available on the market.)	

1. System Configuration

1.6 Programmer port function

The interface of the T1-16S's programmer port is RS-232C. Normally this port is used to connect the programmer. However, this port can also be used for the computer link function.

The computer link is a data communication function between computer or operator interface unit and the T1-16S. The data in the T1-16S can be read and written by creating simple communication program on the computer. The computer link protocol of the T1-16S is published in "T1-16S User's Manual – Communication Function –".

Item	Specifications
Interface	Conforms to RS-232C
Transmission system	Half-duplex
Synchronization	Start-stop system (asynchronous)
Transmission speed	9600 bps (fixed)
Transmission distance	15 m max.
Framing	Start bit: 1 bit Data bits: 8 bits (fixed) Parity: Odd or none Stop bit: 1 bit (fixed)
Protocol	T-series computer link (ASCII) Programmer (binary)
Transmission delay option	0 to 300 ms

By using the multi-drop adapter (CU111), multiple T1-16Ss can be connected on an RS-485 line. The T-series PLC programming software (T-PDS) can also be used in this configuration.

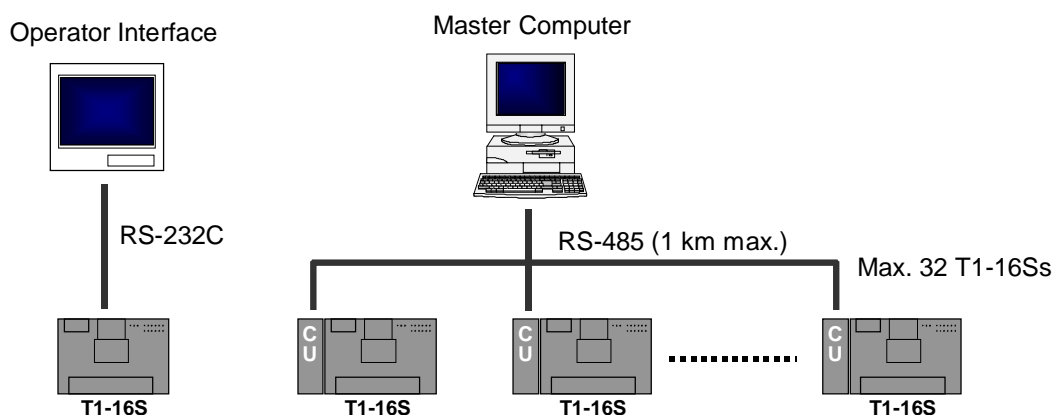

1. System Configuration

1.7 RS-485 port communication function

The T1-16S enhanced model has an RS-485 multi-purpose communication port. This port can work independent of the programmer port.

By using this communication port, one of the following four communication modes is available, computer link mode, data link mode, free ASCII mode, and Inverter connection mode.

For details of these functions, refer to the separate manual “T1-16S User’s Manual – Communication Function –”.

Item	Computer link	Free ASCII	Inverter connection	Data link
Interface	Conforms to RS-485			
Transmission system	Half-duplex			
Synchronization	Start-stop system (asynchronous)			
Transmission code	ASCII/binary	ASCII	Binary	Binary
Transmission speed	300, 600, 1200, 2400, 4800, 9600, or 19200 bps			19200 bps (fixed)
Transmission distance	1 km max.			
Framing	Start bit: 1 bit Data bits: 7 or 8 bits Parity: Odd, even, or none Stop bit: 1 or 2 bits			Special
Protocol	T-series computer link (ASCII), Programmer (binary)	User defined ASCII messages	Inverter VF-A7/G7/S9 binary protocol	Special
Link configuration	1-to-N	N/A	1-to-N	1-to-1

NOTE  T1-16S standard model does not have the RS-485 interface.

1. System Configuration

Computer link mode

T-series computer link protocol can be used in this mode. A maximum of 32 T1-16Ss can be connected to a master computer.

By using this mode, all the T1-16S's data can be accessed by a master computer. The T-series PLC programming software (T-PDS) can also be used in this configuration.

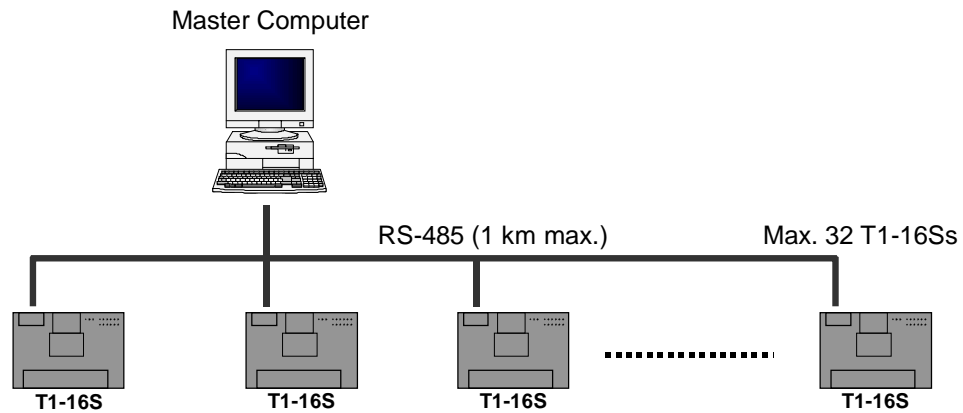

Data link mode

Two PLCs (any combination of T1-16S, T2E or T2N) can be directly linked together. This direct link is inexpensive, easily configured and requires no special programming. Data registers D0000 to D0031 are used for the data transfer.

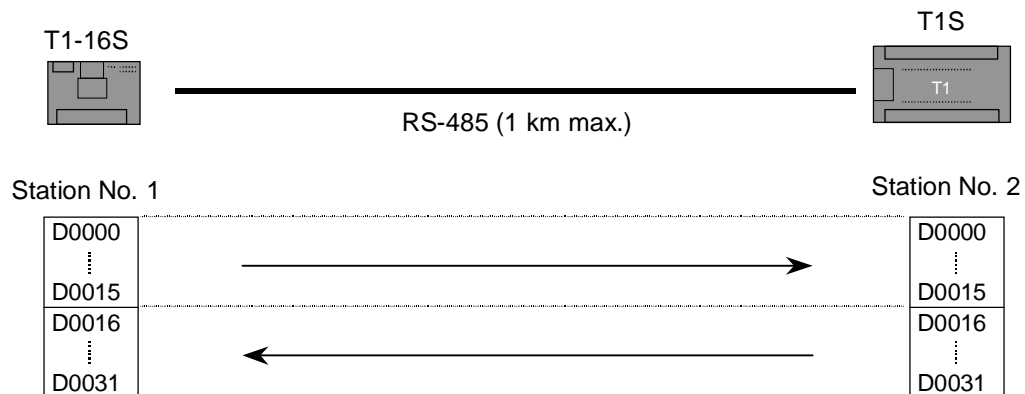

1. System Configuration

Free ASCII mode

The free ASCII mode is used to connect between the T1-16S and various serial ASCII devices, such as a micro computer, bar code reader, printer, display, etc. By using this mode, the T1-16S can work as a communication master. Therefore, the T1-16S can communicate with other PLCs using the computer link protocol.

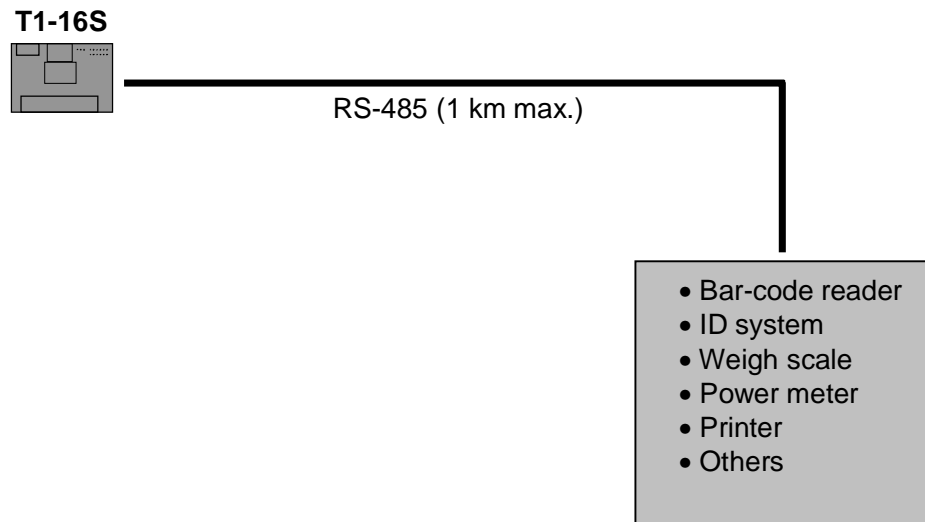

1. System Configuration

Free ASCII mode

The T1-16S's Inverter connection mode is a special function to monitor/control the Toshiba Inverters (ASDs) VF-A7/G7/S9 through the RS-485 line.

Using this mode, the T1-16S can perform the following functions for the Inverters connected on the RS-485 line without any special communication program.

- Monitoring – Operating frequency and Terminal status
- Control – Run/Stop/Jog, Forward/Reverse, Frequency reference, etc.
- Parameter read/write
- Broadcast command

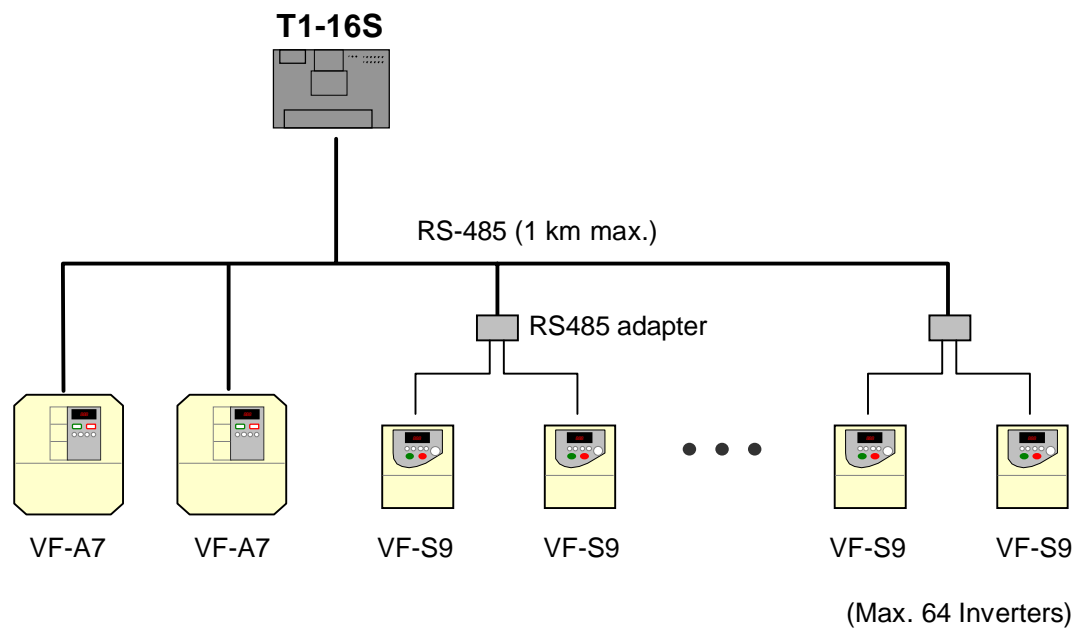

1. System Configuration

1.8 Real-time data link system

TOSLINE-F10

TOSLINE-F10 is a high speed data transmission system suited for small points I/O distribution system. By inserting the TOSLINE-F10 remote module (FR112M), the T1-16S can work as a remote station of the TOSLINE-F10 network. On this network, the T1-16S sends 1 word data to the master station and receives 1 word data from the master station.

Item	TOSLINE-F10 system specifications	
	High speed mode	Long distance mode
Topology	Bus (terminated at both ends)	
Transmission distance (without repeater)	500 m max. (total)	1 km max. (total)
Transmission speed	750 kbps	250 kbps
Scan transmission capacity	512 points (32 words) max.	
Scan cycle	7 ms/32 words	12 ms/32 words
Error checking	CRC check	



- (1) Refer to the separate "T1 User's Manual – Option Card and I/O Module –" for details of the TOSLINE-F10 remote card (FR112).
- (2) Refer to the separate TOSLINE-F10 User's Manual for details of overall TOSLINE-F10 system.

Typical data link configuration

The figure below shows the typical data link configuration.

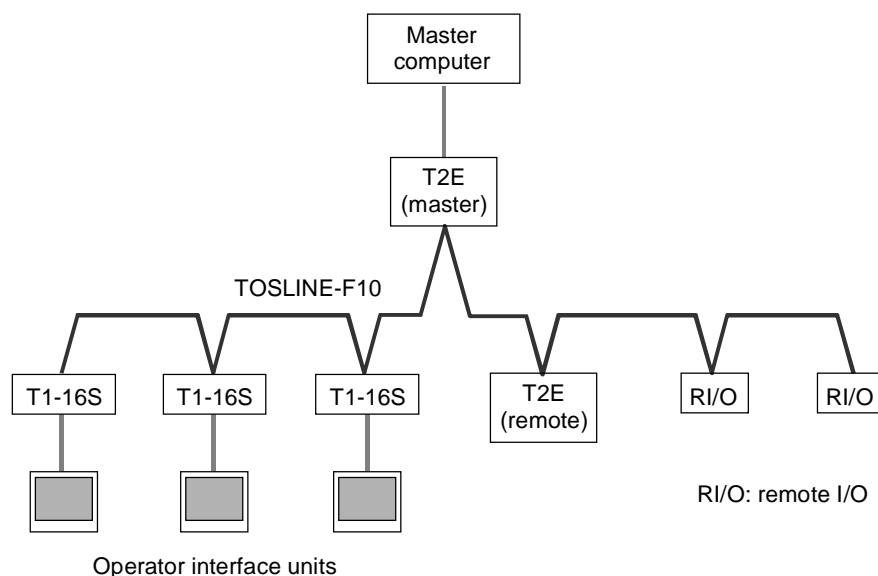

1. System Configuration

1.9 Peripheral tools

The following peripheral tools are available for the T1-16S.

T-Series Program Development System (T-PDS)

The T-Series Program Development System (T-PDS) is a software which runs on any IBM-PC compatible personal computers such as Toshiba's Notebook computers. The same T-PDS software supports on-line/off-line programming, debugging and program documentation for all the T-Series programmable controllers T1/T1S, T2/T2E/T2N, T3/T3H and S2T.

- User-friendly program editor includes cut & paste, address search & replace, program block move/copy, etc.
- Group programming – part program development by multiple designers and merging them into a complete program – enhance the software productivity.
- Powerful monitoring, I/O force and data set functions fully support your program debugging.
- Documentation of programs with commentary makes your maintenance work easy.
- Remote monitoring/programming via modem (radio/phone) is possible.

The table below shows the T-PDS versions that support the T1-16S.

Type	Part number	Versions available for	
		T1-16/28/40	T1-40S/T1-16S
T-PDS for Windows	TMW33E1SS	Ver 1.0 or later ^{*1)}	Ver 1.2 or later
T-PDS for MS-DOS	TMM33I1SS	Ver 1.61 or later ^{*1)}	Ver 2.1 or later

*1) The T1-16S can be used with these versions. However, in this case, there are the following functional limitations.

- The program size setting is only available as 2 k. It is set to 4 k mode in the T1-16S.
- Some of the added instructions (MAVE, DFL, HTOA, ATOH) may not be edited/monitored. (depending on the version)



The connection cable for the T1-16S is different from that for upper T-Series PLCs. These cables are supplied separately.

Connection cable for T1-16S ... Type: CJ105, 5 m length

Connection cable for T2/T3 Type: CJ905, 5 m length

1. System Configuration

T-Series Handy Programmer (HP911A)

The HP911A is a hand-held programmer, that can be used to program the T1-16S using ladder diagram. Its portability makes it ideal for maintenance use at remote locations.

The HP911A has the following features.

- The HP911A supports ladder diagram programming of T-Series programmable controllers T1-16S, T2/T2E/T2N and T3.
- Built-in EEPROM allows program copy between T-Series controllers.
- Two display modes are available,
 - Normal: 5 lines and 12 columns
 - Zoom: Full device description
- On-line data set and I/O force are useful for system checking.
- Backlit LCD display allows operation in dim light.

There are two types of the Handy Programmer (HP911) depending on the cable included with.

Type	Part number	Cable included with	Versions available for T1-16S
HP911A	THP911A*S	2 m cable for T1-16S	Ver 1.1 or later
HP911	THP911**S	2 m cable for the upper T-series PLCs	Ver 1.1 or later

The T1-16S can be used with the HP911(A). However, there are the following functional limitations.

- The program size setting is only available as 2 k. It is set to 4 k mode in the T1-16S.
- Some of the added instructions (MAVE, DFL, HTOA, ATOH) cannot be edited/monitored.



A 2 m connection cable for the T1-16S (Type: CJ102) is supplied with the HP911A. The cable for the T2/T3 is available separately. (Type: CJ902, 2 m length)

1. System Configuration

Program Storage Module (RM102)

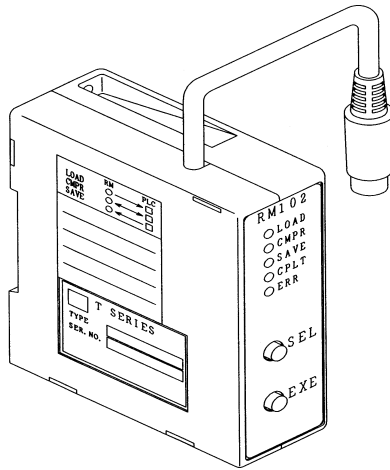

The program storage module (RM102) is an external memory for storing the T1-16S program. By using the RM102, program saving from the T1-16S to the RM102, and program loading from the RM102 to the T1-16S can be done without need of a programmer. Because the RM102 has an EEPROM, maintenance-free program storage and quick saving/loading are available.

Multi-drop adapter (CU111)

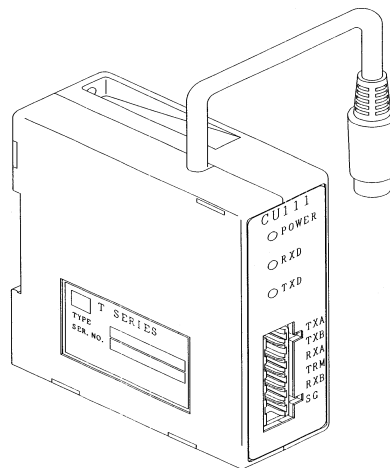

The T1-16S's RS-232C programmer port supports the computer link function. When two or more T1-16Ss are connected with a master computer, the multi-drop adapter (CU111) can be used. (One-to-N configuration) The CU111 is an RS-232C/RS-485 converter specially designed for the T1-16S's programmer port.

Section 2

Specifications

- 2.1 *General specifications, 38*
- 2.2 *Functional specifications, 40*
- 2.3 *I/O specifications, 42*
- 2.4 *External dimensions, 46*

2. Specifications

2.1 General specifications

Item		T1-16S
AC Power type	Power supply voltage	100 to 240Vac (+10/-15%), 50/60 Hz
	Power consumption	45VA or less
	Inrush current	50A or less (at 240Vac, cold start)
	Output rating (Note)	24Vdc (24Vdc, $\pm 10\%$) 5Vdc
DC Power type	Power supply voltage	24Vdc (+20/-15%)
	Power consumption	18W or less
	Inrush current	25A or less (at 24Vdc)
	5Vdc output rating (Note)	1.5A (for I/O module)
Retentive power interruption		10ms or less
Insulation resistance		10M Ω or more (between power terminals and ground terminal)
Withstand voltage		1500Vac - 1 minute
Ambient temperature		0 to 55°C (operation), -20 to 75°C (storage)
Ambient humidity		5 to 95%RH, no condensation
Noise immunity		1000Vp-p/1 μ s, Conform to EMC Directive 89/336/EEC
Vibration immunity		9.8m/s ² (1g) (for 30 minutes per axis, on 3 mutually perpendicular axes)
Shock immunity		98m/s ² (10g) (3 shocks per axis, on 3 mutually perpendicular axes)
Approximate weight		500g



- (1) 24Vdc service power output is not provided on the DC power supply type.
 (2) The maximum output current of the 5Vdc is 1.5A. However there is the following restrictions, depending on the conditions.

- When HP911 is used:
→ Reduced by 0.2A
- When RS-485 port is used:
→ Reduced by 0.1A
- When 24Vdc service power is used:
→ Refer to the right chart.

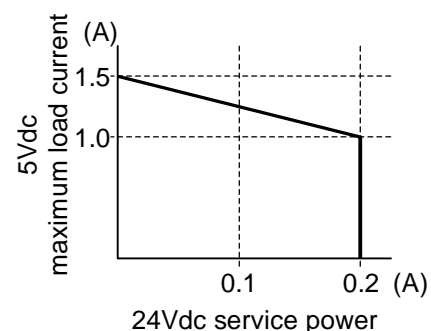

2. Specifications



- (3) The 5Vdc current consumption of each I/O modules is described below. Check that the total 5Vdc current consumption is within the limit.

Model	Specifications	5Vdc consumer current
DI116M	16points, 24Vdc-5mA input.	50mA
DO116M	16points, 24Vdc-100mA output.	50mA
DD116M	8points, 24Vdc-5mA input. 8points, 24Vdc-100mA output.	50mA
RO108M	8 points, 24Vdc/240Vac – 1A relay output	260mA
AD121M	1ch. 12bit analog input. (0 to 20mA, 0 to 5V)	260mA
AD131M	1ch. 12bit analog input. ($\pm 10V$)	260mA
DA121M	1ch. 12bit analog output. (0 to 20mA, 0 to 5V)	350mA
DA131M	1ch. 12bit analog output. ($\pm 10V$)	240mA
TC111M	1ch. 12bit thermo couple input.	400mA
FR112M	TOSLINE-F10 remote station.	100mA

2. Specifications

2.2 Functional specifications

Item		T1-16S
Control method		Stored program, cyclic scan system
Scan system		Floating scan or constant scan (10 – 200ms, 10ms units)
I/O update		Batch I/O refresh (direct I/O instruction available at basic unit's I/O)
Program memory (Note)		RAM and EEPROM (no back-up battery required)
Program capacity		8K steps (4K or 8K mode)
Programming language		Ladder diagram with function block
Instructions		Basic: 21 Function: 97
Execution speed		1.4μs/contact, 2.3μs/coil, 4.2μs/16-bit transfer, 6.5μs/16-bit addition
Program types		1 main program 1 sub-program (initial program) 1 timer interrupt (interval: 5 to 1000ms, 5ms units) 4 I/O interrupt (high-speed counter and interrupt input) 256 subroutines (up to 3 levels of nesting)
User data	I/O register	512 points/ 32 words (X/XW, Y/YW)
	Auxiliary relay	4096 points/ 256 words (R/RW)
	Special relay	1024 points/ 64 words (S/SW)
	Timer	256 points (T./T) 64 at 0.01s, 192 at 0.1s
	Counter	256 points (C./C)
	Data register	4096 words (D)
	Index register	3 words (I, J, K)
Memory back-up	Capacitor	1 hour (at 25°C)
	Battery (option)	Max. 2 years. Min. 6 months. (Note)



- (1) The user program stored in the EEPROM is transferred to the RAM when power is turned on. Therefore, if the program is modified, it is necessary to issue the EEPROM Write command from the programming tool. Otherwise, the modified program is over-written by original EEPROM contents at the next initial load timing.
- (2) The data of RAM and calendar IC are backed up by built-in capacitor and optional battery.
- (3) When the optional battery is used, replace the battery periodically with referring to the table below.

		Annual average air temperature	
		Under 30°C (86°F)	Over 30°C (86°F)
Operation time per day	Over 8 hours	2 years	1 year
	Under 8 hours	1 year	6 months

2. Specifications

Functional specifications (cont'd)

Item	T1-16S	
I/O capacity	16 points (basic) +128 points (I/O modules)	
I/O type	Input	24Vdc input (8 points)
	Output	Relay (6 points) + transistor (2 points)
I/O terminal block	Fixed	
Real-time clock /calendar	Yes, ± 60 s/month at 25°C (Enhanced model only)	
Special I/O functions (Note)	<ul style="list-style-type: none"> • High speed counter, 2 single or 1 quadrature • Interrupt input, 2 points • Adjustable analog register, 2 points • Pulse output, CW+CCW or pulse+direction • PWM output 	
Communications interface	<ul style="list-style-type: none"> • 1 port RS-232C (programmer port) <ul style="list-style-type: none"> - for Programmer or Computer link connection • 1 port RS-485 (Enhanced model only) <ul style="list-style-type: none"> - Programmer - Computer link - Data link - Free ASCII • TOSLINE-F10 remote (by I/O module) 	
Debug support function	<ul style="list-style-type: none"> • Sampling trace, 8 devices and 3 register - 256 times • On-line programming • On-line EEPROM write 	



- (1) High-speed counter, interrupt input, pulse output and PWM output are available in the DC input types.
- (2) High-speed counter and interrupt input cannot be used simultaneously.
- (3) Pulse output and PWM output cannot be used simultaneously.

2. Specifications

2.3 I/O specifications

- Input specifications

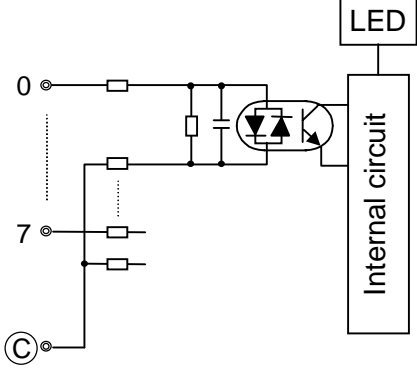
Item	Specifications
Input type	DC input, current source/sink
Number of input points	8 points (8 points/common)
Rated input voltage	24Vdc, +10/-15 %
Rated input current	7mA (at 24Vdc)
Min. ON voltage	15Vdc
Max. OFF voltage	5Vdc
ON delay time	0 to 15ms ^{*1}
OFF delay time	0 to 15ms ^{*1}
Input signal display	LED display for all points, lit at ON, internal logic side
External connection	Removable terminal block, M3
Withstand voltage	1500Vac, 1 minute (between internal and external circuits)
Internal circuit	

*1: User can change the input ON/OFF delay time of the DC input.
The setting range is 0 to 15ms. (Default value = 10ms) Refer to section 8.2.

2. Specifications

- Input signal connections

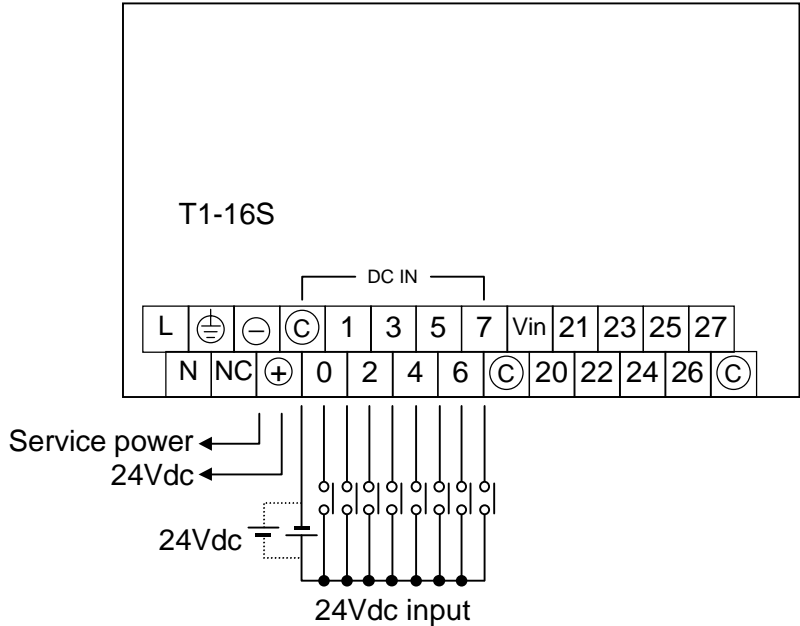

The 24Vdc service power output is not provided on the DC power supply type.

2. Specifications

• Output specifications

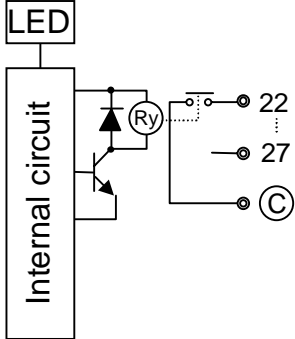
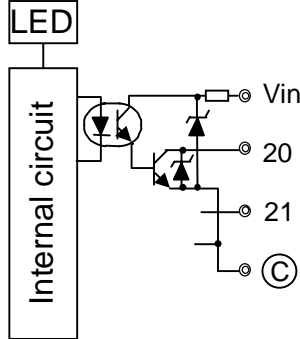
Item	Specifications	
	Relay output	Transistor output
Output type	Relay contact, normally open	Transistor output, current sink
Number of output points	6 points (6 pts/common)	2 points (2 points/common)
Rated load voltage	240Vac/24Vdc (max.)	24Vdc
Range of load voltage	Max. 264Vac/125Vdc	20.0 - 28.0Vdc
Maximum load current	2A/point (resistive), 4A/common	0.5A/point (resistive)
ON resistance	50mΩ or less (initial value)	–
Voltage drop at ON	–	0.5V or less
Leakage current at OFF	None	0.1mA or less
Minimum load	5Vdc, 10mA (50mW)	–
ON delay time	10ms or less	0.1ms or less
OFF delay time	10ms or less	0.1ms or less
Input signal display	LED display for all points, lit at ON, internal logic side	
External connection	Removable terminal block, M3	
Withstand voltage	1500Vac, 1 minute (between internal and external circuits)	
Internal circuit		

- *1: The switching life of the relay output is as follows.
 20 million times or more (mechanical)
 100 thousand times or more (electrical, at maximum rated voltage and current)

2. Specifications

- Output signal connections

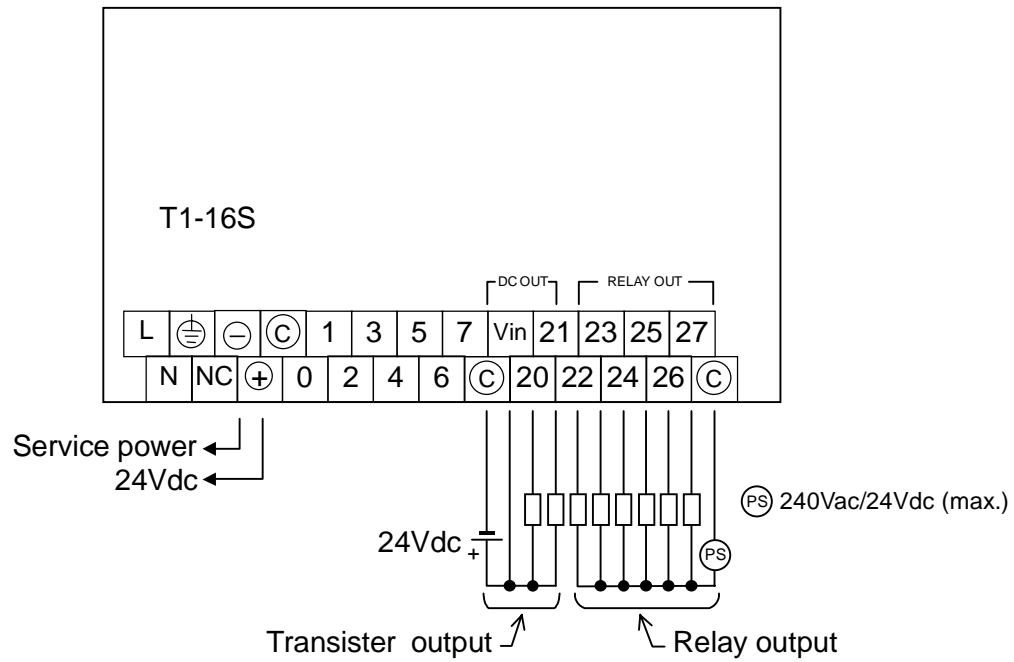

2. Specifications

2.4 External dimensions

◆ T1-16S

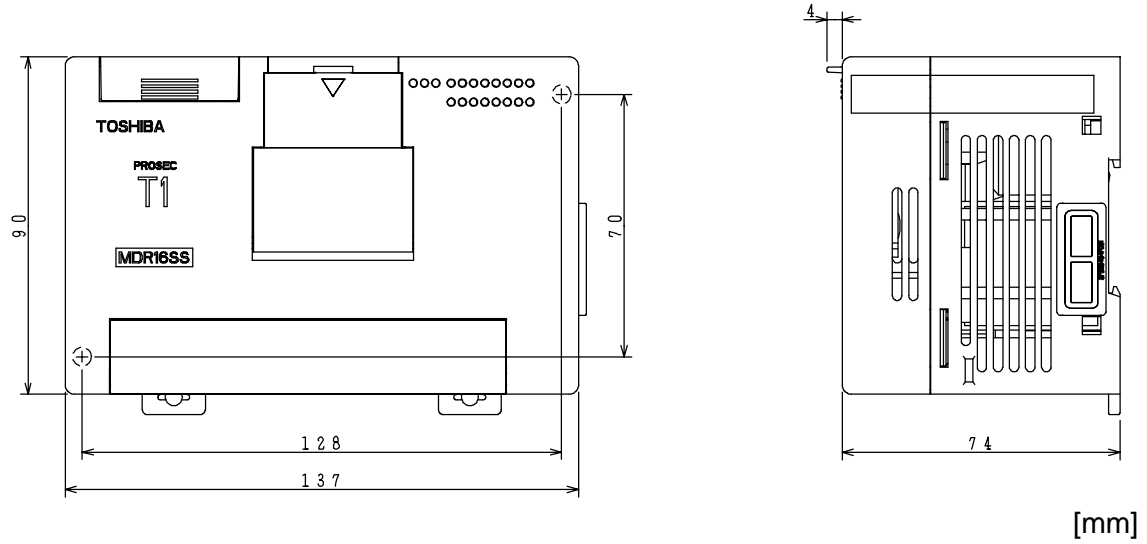

◆ I/O module

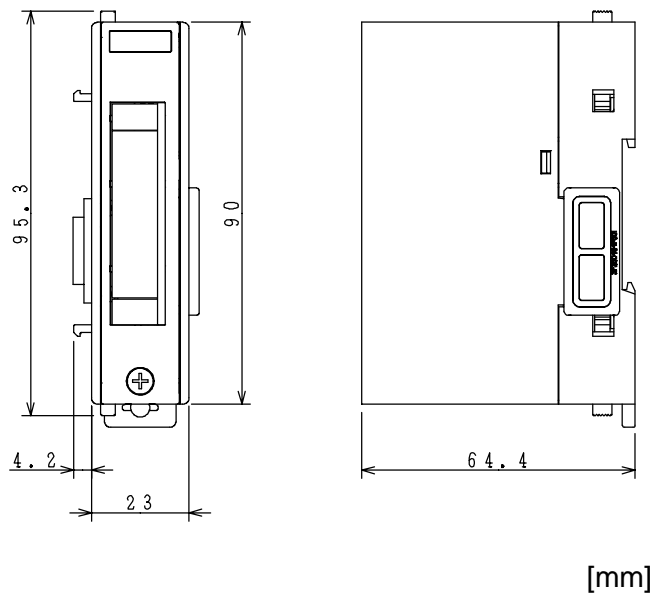

Section 3

I/O Application Precautions

- 3.1 *Application precautions for input signals, 48*
- 3.2 *Application precautions for output signals, 50*

3. I/O Application Precautions

3.1 Application precautions for input signals

⚠ WARNING Configure emergency stop and safety interlocking circuits outside the T1-16S. Otherwise, malfunction of the T1-16S can cause injury or serious accidents.

(1) Minimum ON/OFF time of the input signal

The following conditions guarantee correct reading of the ON/OFF state of the input signal:

Input ON time: ON delay time + the time for one scan

Input OFF time: OFF delay time + the time for one scan

The ON and OFF times of the input signals must be longer than these intervals.

(2) Increasing the contact current

The reliability of some contacts cannot be guaranteed by the specified input current. In this case, install an external bleeder resistor to increase the contact current.

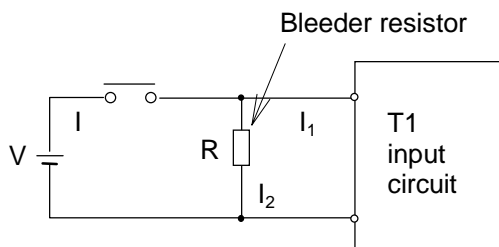

$$R = \frac{V}{I - I_1}$$

$$\text{Wattage} > \frac{V^2}{R} \times 3$$

(3) Connecting transistor output device

An example of connecting a transistor output device to T1-16S's input circuit is shown below.

- For NPN open collector

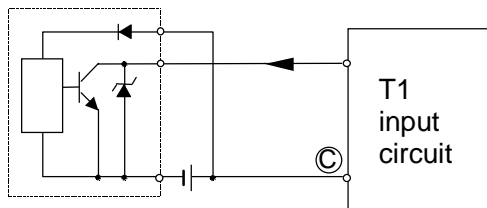

- For PNP open collector

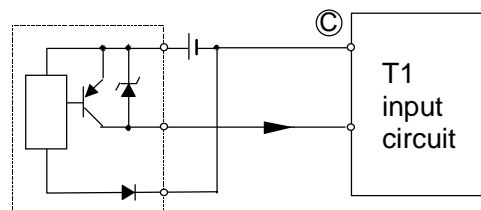

3. I/O Application Precautions

(4) Countermeasures against leakage current

When a switch with an LED or sensor is used, the input sometimes cannot recognize that the switch is off due to the current leakage. In this case, install a bleeder resistor to reduce input impedance.

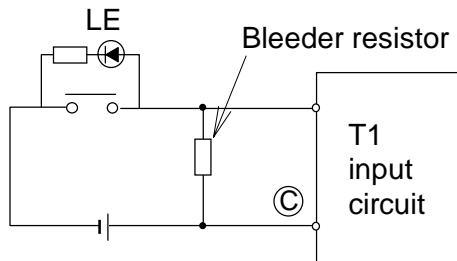

Select a bleeder resistor according to the following criteria:

- The voltage between the input terminals must be lower than the OFF voltage when the sensor is switched off.
- The current must be within the allowable range when the sensor is switched on.
- Calculate the wattage of the bleeder resistor by multiplying the current when the sensor is switched on times three.

3. I/O Application Precautions

3.2 Application precautions for output signals

⚠ WARNING Configure emergency stop and safety interlocking circuits outside the T1-16S. Otherwise, malfunction of the T1-16S can cause injury or serious accidents

⚠ CAUTION

1. Turn on power to the T1-16S before turning on power to the loads. Failure to do so may cause unexpected behavior of the loads.
2. Configure the external circuit so that the external 24Vdc power required for the transistor output circuits and power to the loads are switched on/off simultaneously. Also, turn off power to the loads before turning off power to the T1-16S.
3. Install fuses appropriate to the load current in the external circuits for the outputs. Failure to do so can cause fire in case of load over-current.

(1) 2 points of solid-state output

The leading 2 points of output (Y020 and Y021) are solid-state outputs, transistors on the DC input types.

These solid-state outputs are suited for frequent switching applications.

Note that the specifications of the solid-state outputs and other outputs (relays) are different.

(2) Switching life of output relays

Expected relay life is more than 100,000 electrical cycles at rated maximum voltage and current, and more than 20 million mechanical cycles. The expected contact life (electrical cycles) is shown on the table below.

	Load voltage	Load current	Expected life (thousand)
AC load	110Vac, $\text{COS}\phi = 1$	2A	340
		1A	720
		0.5A	1,600
	110Vac, $\text{COS}\phi = 0.7$	2A	150
		1A	320
		0.5A	700
	220Vac, $\text{COS}\phi = 1$	2A	220
		1A	500
		0.5A	1,100
	220Vac, $\text{COS}\phi = 0.7$	2A	100
		1A	210
		0.5A	460

	Load voltage	Load current	Expected life (thousand)
DC load	24Vdc, L/R = 0 ms	2A	280
		1A	600
		0.5A	1,300
	24Vdc, L/R = 15 ms	2A	60
		1A	150
		0.5A	350
	48Vdc, L/R = 0 ms	1A	200
		0.5A	420
	48Vdc, L/R = 15 ms	0.5A	130
		0.2A	420
	110Vdc, L/R = 0 ms	0.5A	200
		0.2A	550
	110Vdc, L/R = 15 ms	0.2A	150
		0.1A	350

3. I/O Application Precautions

(3) Over-current protection

The output circuit of the T1-16S does not contain protective fuses. Fuses rated for the output should be provided by the user.

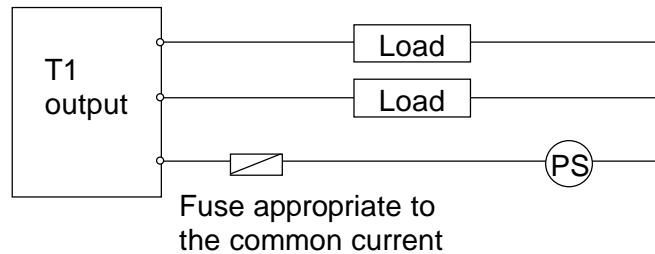

(4) Output surge protection

Where an inductive load is connected to the output, a relatively high energy transient voltage will be generated when the relay turns OFF. To prevent the problems caused by this surge, install a surge absorber in parallel to the inductive load.

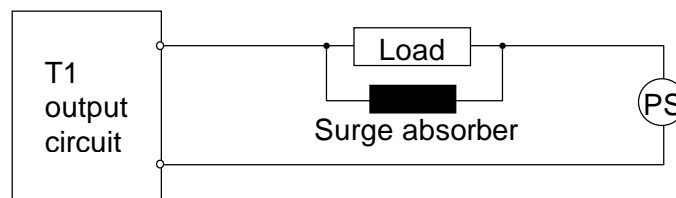

Surge absorber:

- Flywheel diode (for DC output)



Inverse withstand voltage: At least three times that of the power supply

Forward current: Larger than the load current

- Varistor (for AC output)

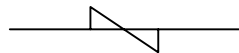

The voltage rating is 1.2 times the maximum (peak) voltage of the power supply

- CR snubber (for DC or AC output)

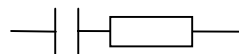

R: 0.5 to 1Ω per volt coil voltage

C: 0.5 to 1μF per ampere of coil current (non-polarity capacitor)

Section 4

Installation and Wiring

- 4.1 Environmental conditions, 54*
- 4.2 Installing the unit, 55*
- 4.3 Wiring terminals, 57*
- 4.4 Grounding, 58*
- 4.5 Power supply wiring, 59*
- 4.6 I/O wiring, 61*

4. Installation and Wiring

4.1 Environmental conditions



CAUTION

Excess temperature, humidity, vibration, shocks, or dusty and corrosive gas environment can cause electrical shock, fire or malfunction. Install and use the T1-16S and related equipment in the environment described in this section.

Do not install the T1-16S in the following locations:

- Where the ambient temperature drops below 0°C or exceeds 55°C.
- Where the relative humidity drops below 20% or exceeds 90%.
- Where there is condensation due to sudden temperature changes.
- In locations subject to vibration that exceeds tolerance.
- In locations subject to shock that exceeds tolerance.
- Where there are corrosive or flammable gases.
- In locations subject to dust, machining debris or other particles.
- In locations exposed to direct sunlight.

Observe the following precautions when installing enclosures in which the T1-16S will be installed:

- Provide the maximum possible distance from high-voltage or high-power panels. This distance must be at least 200mm.
- If installing the enclosures in the vicinity of high-frequency equipment, be sure to correctly ground the enclosures.
- When sharing the channel base with other panels, check for leakage current from the other panels or equipment.

4. Installation and Wiring

4.2 Installing the unit

CAUTION

1. Improper installation directions or insufficient installation can cause fire or the units to drop. Install the T1-16S and related equipment in accordance with the instructions described in this section.
2. Turn off power before installing or removing any units, modules, racks or terminal blocks. Failure to do so can cause electrical shock or damage to the T1-16S and related equipment.
3. Entering wire scraps or other foreign debris into to the T1-16S and related equipment can cause fire or malfunction. Pay attention to prevent entering them into the T1 and related equipment during installation and wiring.



NOTE The T1-16S basic unit and the I/O module come equipped with a bracket at the rear for mounting on a 35mm DIN rail.

Installation precautions:

- Because the T1-16S is not dust-proof, install it in a dust-proof enclosure.
- Do not install the unit directly above equipment that generates a large amount of heat, such as a heater, transformer, or large-capacity resistor.
- Do not install the unit within 200mm of high-voltage or high-power cables.
- Allow at least 70mm on all sides of the unit for ventilation.
- For safety during maintenance and operation, install the unit as far as possible from high-voltage or power equipment. Alternatively, keep the unit separate using a metal plate or similar separator.
- If high-frequency equipment is installed in the enclosure together with the T1-16S, special attention is required for grounding. See section 4.4.
- Be sure to install the unit vertically with keeping the power terminals downside. Do not install the unit horizontally or upside-down for safety reason.
- Use M4 size screws to mount the T1-16S.
(Recommended torque: 1.47N·m = 15Kgf·cm)

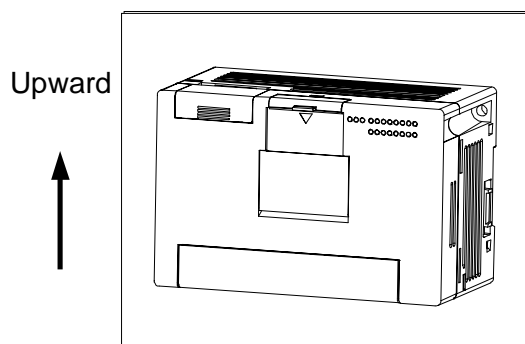

Mount the T1-16S on a vertical panel. All other mounting positions are not acceptable.

4. Installation and Wiring

Dimensions for screw mounting:

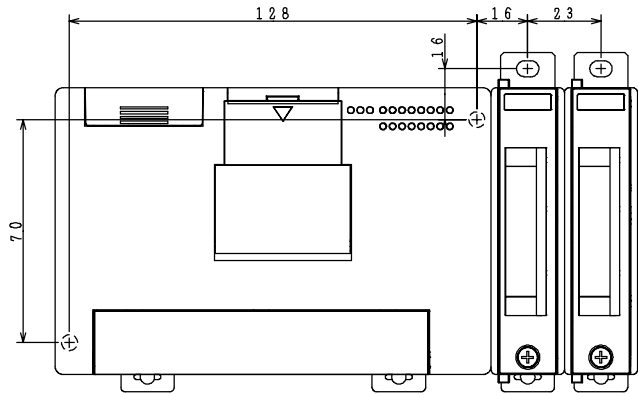

4. Installation and Wiring

4.3 Wiring terminals

CAUTION

1. Turn off power before wiring to minimize the risk of electrical shock.
2. Exposed conductive parts of wire can cause electrical shock. Use crimp-style terminals with insulating sheath or insulating tape to cover the conductive parts. Also close the terminal covers securely on the terminal blocks when wiring has been completed.
3. Turn off power before removing or replacing units, modules, terminal blocks or wires. Failure to do so can cause electrical shock or damage to the T1-16S and related equipment.

The terminal screw size of the T1-16S is M3. Use crimp-style terminals of 7mm width or less useable for M3. The terminal block is not removable (fixed).

NOTE



For input and output signal connections, refer to sections 2.4 and 3.

T1-MDR16SS AC power supply model

RS-485 (Enhanced model only)

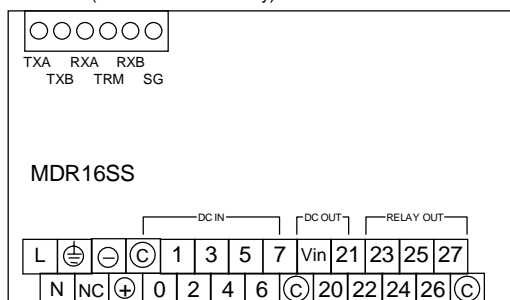

T1-MDR16SSD.. DC power supply model

RS-485 (Enhanced model only)

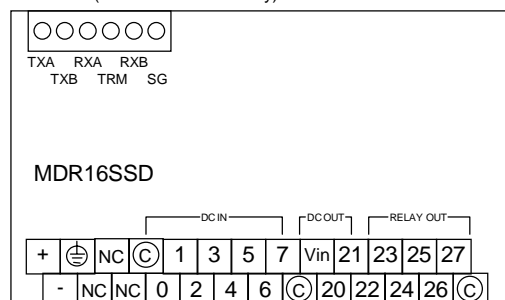

NOTE



- (1) NC stands for "no connect". Do not use the NC terminals for wire relaying or branching.
- (2) For the connections of the RS-485 communication port (the upper terminal block), refer to the separate manual "T1-16S User's Manual - Communication Function -".

The applicable wire size is 0.3mm^2 (22 AWG) to 1.25mm^2 (16 AWG). The table below shows the recommended wire size.

Type of signal	Recommended wire size
Power	1.25mm^2 (16 AWG)
Grounding	1.25mm^2 (16 AWG)
I/O signals	0.3mm^2 (22 AWG) to 0.75mm^2 (18 AWG)

4. Installation and Wiring

4.4 Grounding

-  **CAUTION**
1. Turn off power before wiring to minimize the risk of electrical shock.
 2. Operation without grounding may cause electrical shock or malfunction.
Connect the ground terminal on the T1-16S to the system ground.

The optimum method for grounding electronic equipment is to ground it separately from other high-power systems, and to ground more than one units of electronic equipment with a single-point ground. Although the T1-16S has noise immunity to be used in industrial operating conditions, grounding is important for safety and reliability.

Check the grounding against the following criteria.

1. The T1-16S must not become a path for a ground current. A high-frequency current is particularly harmful.
2. Equalize the ground potentials when the expansion rack or unit is connected.
Ground the T1-16S and the expansion rack or unit at a single point.
3. Do not connect the ground of the T1-16S to that of high-power systems.
4. Do not use a ground that has unstable impedance, such as painted screws, or ground subject to vibration.

The grounding marked terminal (see below) is provided on the T1-16S basic unit for grounding purpose.



In case of the expansion rack is connected to the T1-16S, the rack mounting screw is used for this purpose.

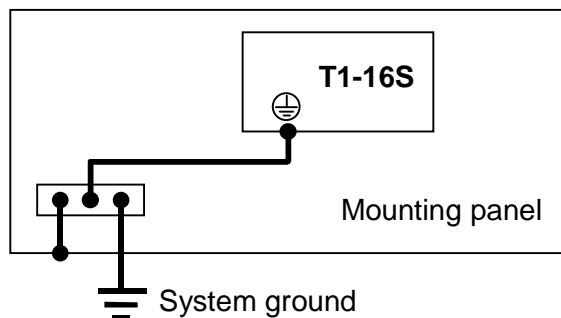

- 1.25mm² (16 AWG) wire should be used to connect the T1-16S and the expansion rack/unit with the enclosure grounding bus bar.
- 100Ω or less to ground is required.

4. Installation and Wiring

4.5 Power supply wiring



CAUTION

1. Turn off power before wiring to minimize the risk of electrical shock.
2. Applying excess power voltage to the T1-16S can cause explosion or fire. Apply power of the specified ratings described below.

Wire the power source to the T1-16S power supply terminals.

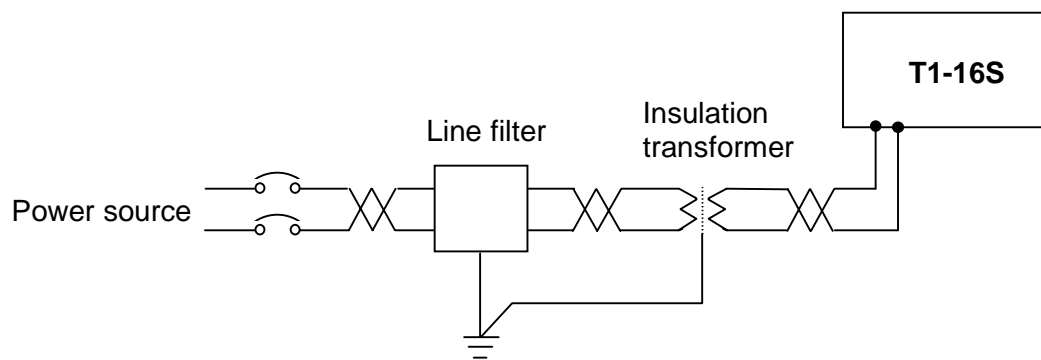

- Power conditions:

	AC power supply type	DC power supply type
Rated voltage	100 to 240Vac, +10/-15%	24Vdc, +20/-15%
Frequency	50/60Hz, ±5%	-
Power consumption	45VA or less	18W or less
Retentive power interruption	Continuous operation for less than 10ms	

- 1.25mm² (16 AWG) twisted-pair cable should be used for the power cable.
- The power cable should be separated from other cables.

4. Installation and Wiring

Connections of the power supply terminals are shown below.

- AC power supply type

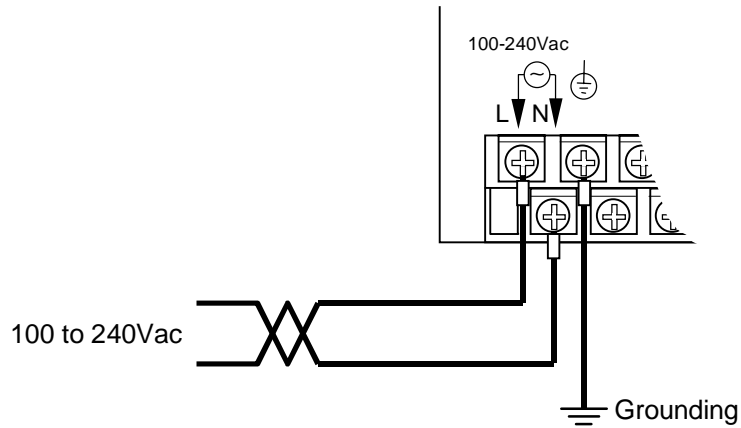

- DC power supply type

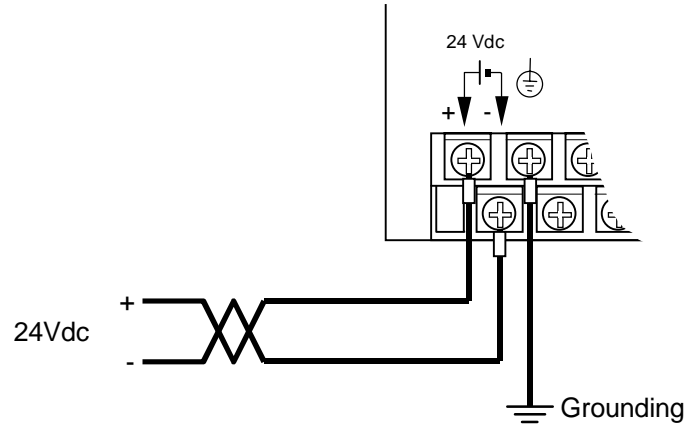

4. Installation and Wiring

4.6 I/O wiring

⚠ CAUTION

1. Turn off power before wiring to minimize the risk of electrical shock.
2. Exposed conductive parts of wire can cause electrical shock. Use crimp-style terminals with insulating sheath or insulating tape to cover the conductive parts. Also close the terminal covers securely on the terminal blocks when wiring has been completed.
3. Turn off power before removing or replacing units, modules, terminal blocks or wires. Failure to do so can cause electrical shock or damage to the T1-16S and related equipment.

- Refer to sections 2.4 and 3 for instructions on how to properly wire the I/O terminals.
- 0.75mm² (18 AWG) to 0.3mm² (22 AWG) wires are recommended for I/O signals.
- Separate the I/O signal cables from high-power cables by at least 200mm.
- If expansion rack or unit is used, separate the expansion cable from the power and I/O signal cables by or unit at least 50mm.
- It is recommended to separate the input signal cables from output signal cables.

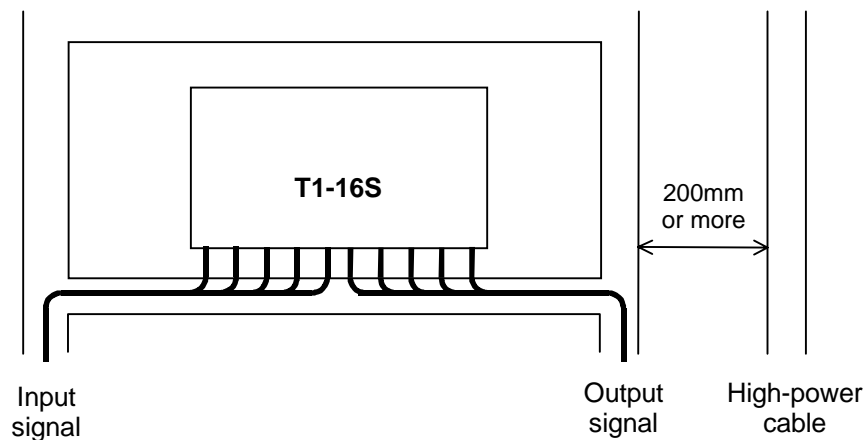

Section 5

Operating System Overview

- 5.1 Operation modes, 64*
- 5.2 About the built-in EEPROM, 66*
- 5.3 Scanning, 69*

5. Operating System Overview

5.1 Operation modes

The T1-16S has three basic operation modes, the RUN mode, the HALT mode and the ERROR mode. The T1-16S also has the HOLD and RUN-F modes mainly for system checking.

RUN: The RUN mode is a normal control-operation mode. In this mode, the T1-16S reads external signals, executes the user program stored in the RAM, and outputs signals to the external devices according to the user program. It is in the RUN mode that the T1-16S performs scans the user program logic, which is the basic operation of a PLC. Program changes and EEPROM write are possible while the T1-16S is in the RUN mode. Refer to section 6.9.

HALT: The HALT mode is a programming mode. In this mode, user program execution is stopped and all outputs are switched off. Program loading into the T1-16S is possible only in the HALT mode. For the standard T1, program changes and EEPROM write are possible only when the T1 is in the HALT mode.

ERROR: The ERROR mode is a shutdown mode as a result of self-diagnosis. The T1-16S enters the ERROR mode if internal trouble is detected by self-diagnosis. In this mode, program execution is stopped and all outputs are switched off. The cause of the shutdown can be confirmed by connecting the programming tool. To exit from the ERROR mode, execute the Error Reset command from the programming tool, or cycle power off and then on again.

HOLD: The HOLD mode is provided mainly for checking the external I/O signals. In this mode, user program execution is stopped, with input and output updating is executed. It is therefore possible to suspend program execution while holding the output state. Moreover, a desired output state can be established by setting any data by using the programming tool.

RUN-F: The RUN-F mode is a forced RUN mode provided for program checking. This mode is effective when using the expansion I/Os. Deferent from the normal RUN mode, the RUN-F mode allows operation even if the registered I/O modules are not actually mounted.

5. Operating System Overview

The operation modes are switched by the mode control switch provided on the T1-16S and the mode control commands issued from the programming tool.

The mode transition conditions are shown below.

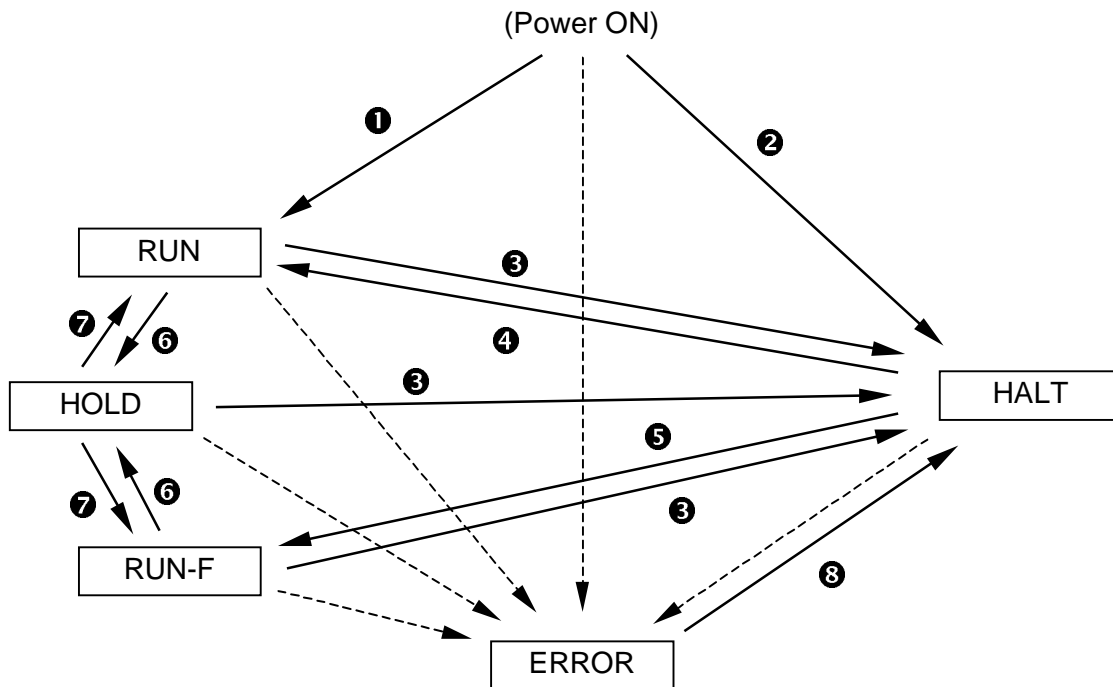

- ❶ Mode control switch is in R (RUN) side.
 - ❷ Mode control switch is in H (HALT) side.
 - ❸ Mode control switch is turned to H (HALT) side, or HALT command is issued from the programming tool.
 - ❹ Mode control switch is turned to R (RUN) side, or RUN command is issued from the programming tool.
 - ❺ Force RUN (RUN-F) command is issued from the programming tool.
 - ❻ HOLD command is issued from the programming tool.
 - ❼ HOLD Cancel command is issued from the programming tool.
 - ❽ Error Reset command is issued from the programming tool.
- ▶ (dotted line) Error is detected by self-diagnosis.



The commands from the programming tool are available when the mode control switch is in R (RUN) side.

5. Operating System Overview

5.2 About the built-in EEPROM

The T1-16S is equipped with a built-in EEPROM and a RAM as standard features. The user program is stored in the EEPROM so that the user program can be maintained without the need of a battery. A part of the Data register can also be stored in the EEPROM.

The table below shows the contents stored in the built-in EEPROM.

	T1-16S
User program	Entire program (8 k steps) and System information
User data	User specified number of Data register starting with address 0. It is set by SW55. D0000 - Dnnnn (up to 2048 words)
Setting information	SW36 - SW38: Programmer port settings SW55: Number of Data register to be saved in the EEPROM SW56 - SW57: RS-485 port settings Sampling trace setting information

The user program and the data stored in the EEPROM are transferred to the RAM when power is turned on. Subsequent program execution is done based on the RAM contents. Program editing is also performed on the RAM contents.

Therefore, if the program is modified, it is necessary to issue the EEPROM Write command from the programming tool. Otherwise, the modified program is overwritten by original EEPROM contents when the power is turned off and on again.

5. Operating System Overview

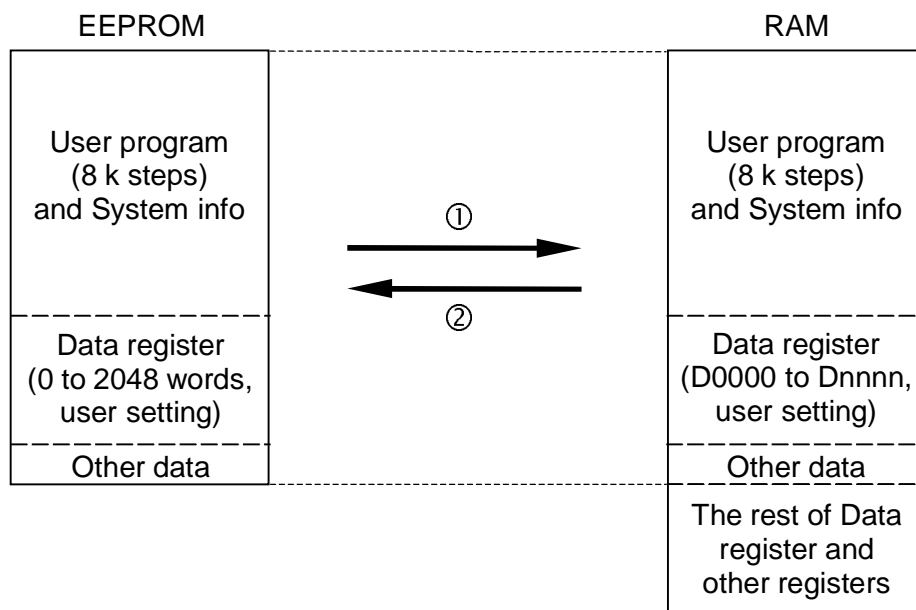

- ① Executed when power is turned on (it is called initial load) or EEPROM Read command is issued from the programming tool. The EEPROM Read is possible only in the HALT mode.
- ② Executed when EEPROM Write command is issued from the programming tool. It is possible in either HALT or RUN mode. (See Note)

5. Operating System Overview

Special register SW55 is used to specify the number of Data registers to be stored in the EEPROM. The allowable setting value is 0 to 2048.

The table below shows the correspondence between the SW55 value and Data registers saved in the EEPROM.

SW55 setting value	Range of Data registers saved in EEPROM	Remarks
0	None	
1	D0000 only	
2	D0000 to D0001	
3	D0000 to D0002	
:	:	
2047	D0000 to D2046	
2048	D0000 to D2047	Default value
Others	D0000 to D2047	Regarded as 2048

When the EEPROM Write command is executed, the T1-16S checks the value of SW55 and saves the Data registers into the EEPROM depending on the SW55 value. The value of SW55 itself is also saved in the EEPROM.

At the initial load or the EEPROM Read command is executed, the T1-16S checks the value for SW55 in the EEPROM and transfers the corresponding number of data to the Data registers of the RAM.



- (1) The EEPROM has the life limit for writing. It is 100,000 times. Pay attention not to exceed the limit. If the number of execution of EEPROM Write command exceeds 100,000 times, EEPROM alarm flag (S007) comes ON.
- (2) Even in RUN mode, the EEPROM Write command can be executed. However, in this case, only the user program is written into the EEPROM. (D register data and setting information are not saved.)
- (3) The data in the EEPROM can also be read or written by using the program instruction (FUN236 XFER instruction).
- (4) When the EEPROM writing is executed by the XFER instruction in the user program, T1-16S does not update the internal EEPROM write counts. Therefore the EEPROM alarm flag (S007) will not correspond to this operation. Pay attention to the life limit of the EEPROM.

5. Operating System Overview

5.3 Scanning

The flowchart below shows the basic internal operations performed by the T1-16S from the time power is turned on through program execution. As the diagram shows, executing a program consists of continuous scanning operations. One scan is a cycle starting with the self-diagnosis and ending with the completion of peripheral support.

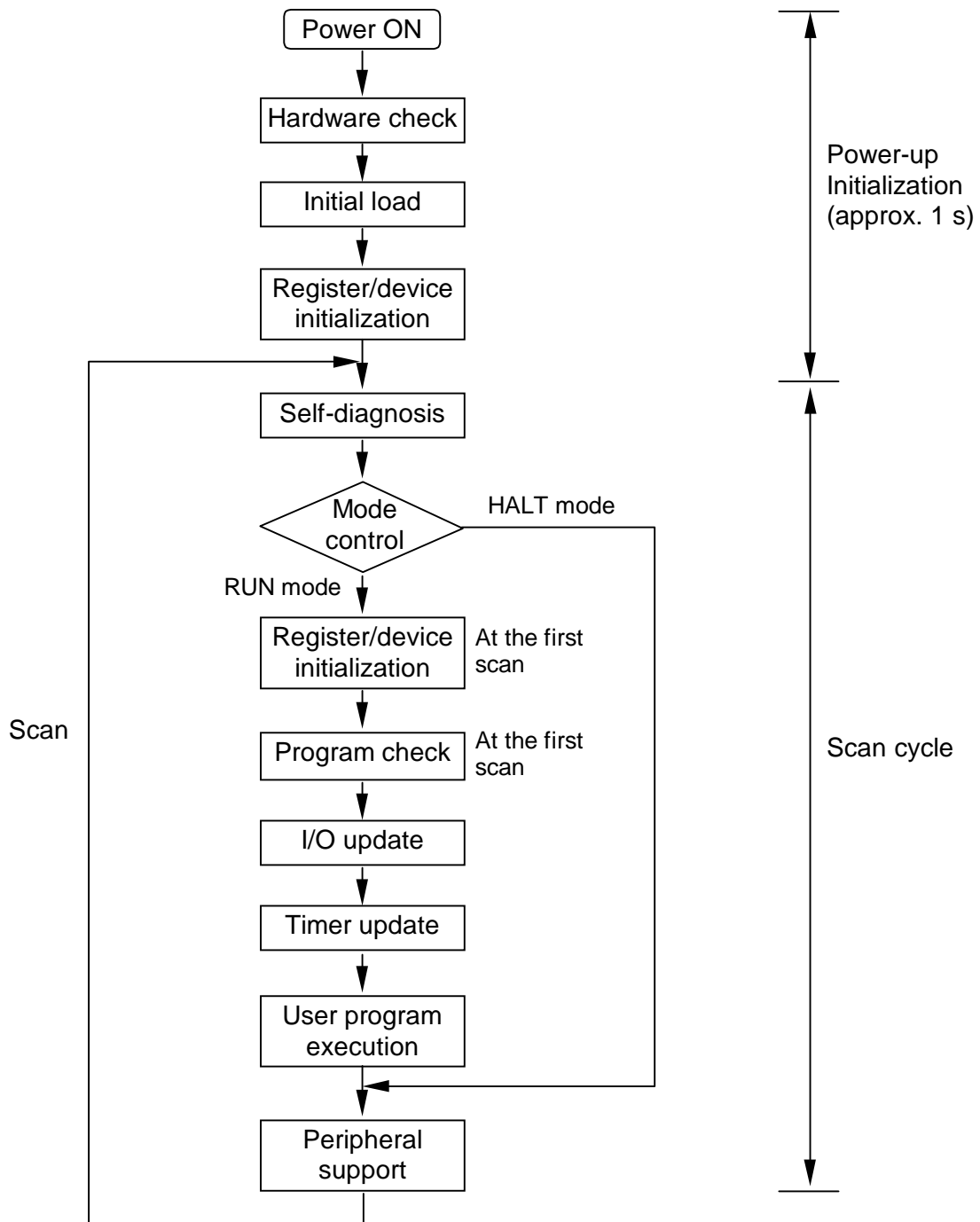

5. Operating System Overview

Hardware check:

Performs checking and initialization of the system ROM, the system RAM and the peripheral LSIs.

Initial load:

Transfers the user program and user data from the EEPROM to the RAM. (Refer to section 5.2)

Register/device initialization:

Initializes registers and devices as shown below.

Register/device	Initialization
External input (X/XW)	Forced inputs are retained. Others are cleared to 0.
External output (Y/YW)	Forced coil devices are retained. Others are cleared to 0.
Auxiliary device/register (R/RW)	User specified retentive registers and forced coil devices are retained. Others are cleared to 0.
Special device/register (S/SW)	Special setting data are retained. Others are cleared to 0.
Timer device/register (T./T)	User specified retentive registers are retained. Others are cleared to 0.
Counter device/register (C./C)	User specified retentive registers are retained. Others are cleared to 0.
Data register (D)	User specified retentive registers are retained. Others are cleared to 0.
Index register (I, J, K)	Cleared to 0.

NOTE



- (1) When the data stored in the EEPROM (Data registers) are used, these registers should be specified as retentive. Otherwise, these data are transferred from EEPROM to RAM, but then cleared to 0 at the initialization.
- (2) The data in the retentive registers are stored in RAM and backed up by built-in capacitor and by the optional battery if used. The back-up period is 1 hours or more at 25 °C. If optional battery (CR2032) is used, the back-up period is 1 year or more at 25 °C. The T1-16S checks the validity of the retentive data at the power-up initialization, and if they are not valid, sets the special device (S00F) to ON. Therefore, check the status of S00F in the user program and initialize the retentive registers if S00F is ON.
- (3) The retentive registers can be set by the programming tool for RW, T, C and D registers. The registers from address 0 to the designated address for each type are set as retentive registers. Refer to the separate manual for the programming tool for setting the retentive registers.
- (4) The input force and the forced coil are functions for program debugging. For details, refer to section 6.7.

5. Operating System Overview

Self-diagnosis:

Checks the proper operation of the T1-16S itself. If an error has detected and cannot be recovered by re-tries, the T1-16S moves into ERROR mode. For the self-diagnosis items, refer to section 10.2.

Mode control:

Checks the mode control switch status and the mode control request commands from the programming tool.

The scan mode – floating scan or fixed-time scan – is also controlled here.



The floating scan:

When one scan is finished, immediately starts the next scan. The scan time is shortest, but may vary depending on the program execution status.

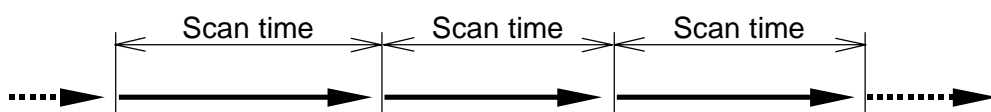

The fixed-time scan:

The scan operation is started every user-specified time. The time setting range is 10 to 200 ms (10 ms units). If an actual scan needs longer time than the setting time, it works as the floating scan.

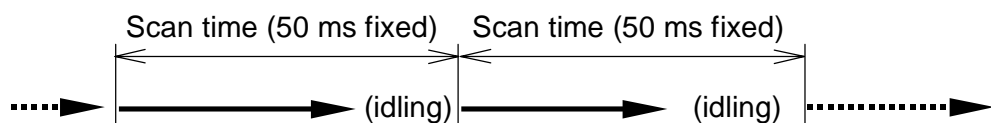

Program check:

At the beginning of the RUN mode, the user program is compiled and its validity is checked.

I/O update:

Reads the external input signals into the external input devices/registers (X/XW), and sends the data of the external output devices/registers (Y/YW) to the external output circuits. Then the outputs (relays, etc.) changes the states and latches until the next I/O update timing.

The states of the forced input devices are not updated by this operation.

Timer update:

Updates the timer registers which are activated in the user program, and the timing devices (S040 to S047).

5. Operating System Overview

User program execution:

Executes the programmed instructions from the beginning to the END instruction.

This is the essential function of the T1-16S.

In this section, only the main program execution is mentioned. For other program types, such as timer interrupt, etc., refer to section 6.5.

Peripheral support:

Supports the communications with the programming tool or external devices connected by the computer link function. The time for this operation is limited within approx. 2 ms in the floating scan mode, and within allowable idling time in the fixed-time scan mode.

If the special relay S158 is set to ON, the peripheral support priority mode is selected. In the peripheral support priority mode, the peripheral support time is not limited. As the result, the communication response is improved although the scan time becomes long at the time.

Section 6

Programming Information

- 6.1 *Devices and registers, 74*
- 6.2 *Index modification, 86*
- 6.3 *Real-time clock/calendar, 88*
- 6.4 *I/O allocation, 89*
- 6.5 *T1-16S memory mode setting, 91*
- 6.6 *User program configuration, 92*
- 6.7 *Programming language, 98*
- 6.8 *Program execution sequence, 99*
- 6.9 *On-line debug support functions, 100*
- 6.10 *Password protection, 103*

6. Programming Information

6.1 Devices and registers

The T1-16S program consists of bit-based instructions that handle ON/OFF information, such as contact and coil instructions, and register-based (16-bit) instructions, such as those for data transfer and arithmetic operations.

Devices are used to store the ON/OFF information of contacts and coils, and registers are used to store 16-bit data.

Devices are divided into six types:

- X External input devices
- Y External output devices
- R Auxiliary relay devices
- S Special devices
- T Timer devices
- C Counter devices

Registers are divided into eight types:

- XW External input registers
- YW External output registers
- RW Auxiliary relay registers
- SW Special registers
- T Timer registers
- C Counter registers
- D Data registers
- I, J, K Index registers

Device and register numbers

X devices share the same memory area as XW registers. Device X004, for example, represents the number 4 bit in the XW00 register.

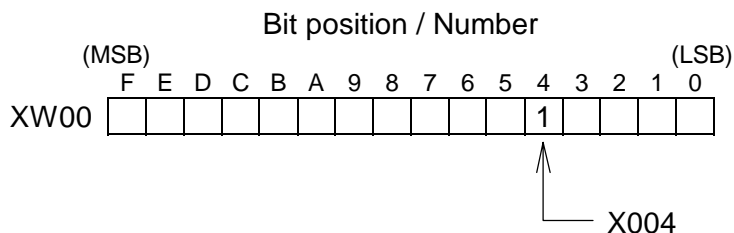

Thus, "X004 is ON" means that bit number 4 of XW00 is 1. Y, R, and S devices work in a similar manner.

6. Programming Information

Addressing devices

A device number of X, Y, R and S devices consist of a register number and bit position as follows.

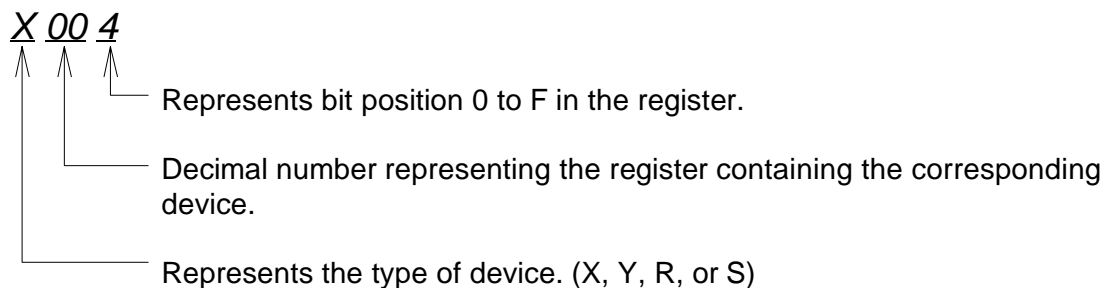

As for the timer (T.) and the counter (C.) devices, a device number is expressed as follows.

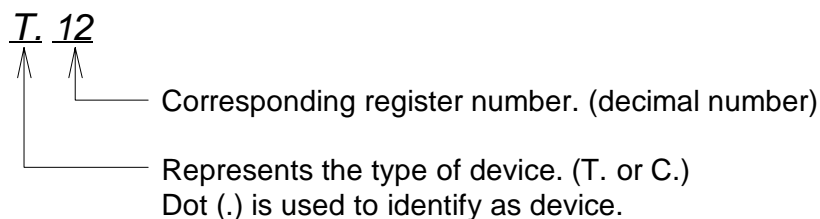

Addressing registers

A register number except the index registers is expressed as follows.

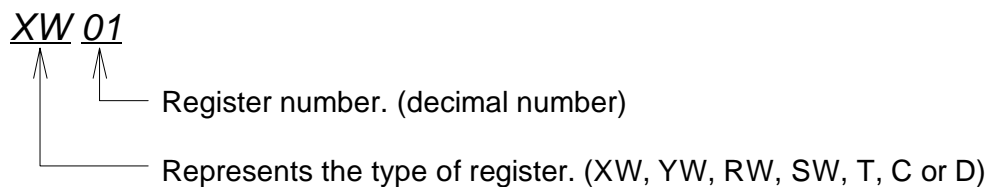

The index registers (I, J and K) do not have the number.

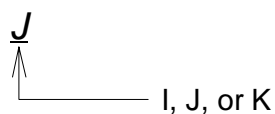

6. Programming Information

Available address range

Device/register	Symbol	T1-16S	
		Number of points	Address range
External input device	X	Total 512 points	X000 - X31F
External output device	Y		Y020 - Y31F
External input register	XW	Total 32 words	XW00 - XW31
External output register	YW		YW02 - YW31
Auxiliary relay device	R	4096 points	R000 - R255F
Auxiliary relay register	RW	256 words	RW000 - RW255
Special device	S	1024 points	S000 - S63F
Special register	SW	64 words	SW00 - SW63
Timer device	T.	256 points	T.000 - T.255
Timer register	T	256 words	T000 - T255
Counter device	C.	256 points	C.000 - C.255
Counter register	C	256 words	C000 - C255
Data register	D	4096 words	D0000 - D4095
Index register	I	1 word	I (no address)
	J	1 word	J (no address)
	K	1 word	K (no address)



- NOTE**
- (1) 1 word = 16 bits
 - (2) The available data range in each register is -32768 to 32767 (H8000 to H7FFF) except for the timer and the counter registers. The data range of the timer register is 0 to 32767. That of the counter register is 0 to 65535.
 - (3) Double-word (32 bits) data is available in two consecutive registers. In this case, lower address register stores the lower 16 bits data.

(MSB) F -----0 F ----- 0 (LSB)

D0101

D0100

Upper 16bits Lower 16bits

In this manual, a double-word register is expressed by using ‘.’.
For example, D0101·D0100.

6. Programming Information

External input devices (X)

These devices (X) indicate the ON/OFF states of external input signals through the input circuits. External input devices can be used many times in a program.

External output devices (Y)

The external output devices (Y) store the ON/OFF signals that drive the external devices through the output circuits. They can be used for coils in a program.

External input registers (XW)

These (XW) are 16-bit registers for storing values, which are received from the input circuits.

External output registers (YW)

These 16-bit registers (YW) are used for storing values, which are sent to the output circuits.

Auxiliary relay devices and registers (R/RW)

The auxiliary relay devices (R) are used to store intermediate results of sequences. The auxiliary relay registers (RW) are used to store temporary results of function instructions. The data in R/RW cannot be output directly to the output circuits. It is necessary to move the data to Y/YW.

It is possible to make these registers retentive so that they retain data in the event of a power failure. See section 5.3.

Timer devices and registers (T./T)

The timer registers (T) are used for storing the elapsed time of timer instructions, the on-delay (TON), off-delay (TOF) and single-shot (SS) timers. 0.01 s base timers and 0.1 s base timers are provided.

Time base	T1-16S
0.01 s	T000 to T063
0.1 s	T064 to T255

The timer devices (T.) work as the output of the timer instructions.

It is possible to specify the T registers as retentive to retain their data in the event of a power failure. See section 5.3.

6. Programming Information

Counter devices and registers (C./C)

The counter registers (C) are used for storing the count value of the counter (CNT) and the up-down counter (U/D) instructions.

The counter devices (C.) work as the output of the counter instructions.

It is possible to specify the C registers as retentive to retain their data in the event of a power failure. See section 5.3.

Data registers (D)

Functionally the data registers (D) are the same as auxiliary relay registers (RW) except that the D registers cannot be used as devices.

A part of the data registers are saved in the built-in EEPROM as fixed data and transferred into the RAM at the initial load.

The range of the data registers saved in the EEPROM can be specified by SW55. See section 5.2.

It is possible to specify the D registers as retentive to retain their data in the event of a power failure. See section 5.3.

Index registers (I, J, and K)

These index registers are used for indirect addressing for a register.

For example, if the value of I is 100 in the following register expression, it designates D0100. For details, refer to section 6.2.

I
D0000 —————> D0100 if I=100

6. Programming Information

Special devices and registers (S/SW)

The special devices (S) and special registers (SW) are used for special purposes. See list below.

Device/ register	Name	Function
S000	T1/T1S operation mode	0: Initialization
S001		4: HOLD mode
S002		6: ERROR mode
S003		1: HALT mode 2: RUN mode 3: RUN-F mode
S004	CPU error (down)	ON at error state (related to SW01)
S005	I/O error (down)	ON at error state (related to SW02)
S006	Program error (down)	ON at error state (related to SW03)
S007	EEPROM alarm (alarm)	ON when EEPROM write exceeds 100,000 times
S008	Fixed-time scan time-over (alarm)	ON when actual scan time is longer than the setting time as fixed-time scan
S009	–	Reserved
S00A	Clock/calendar error (alarm)	ON when clock/calendar data is illegal
S00B	–	Reserved
S00C	–	Reserved
S00D	TL-F10 error (alarm)	ON when TOSLINE-F10 transmission error occurs
S00E	–	Reserved
S00F	Retentive data invalid (alarm)	ON when retentive data in RAM are invalid



- NOTE**
- (1) These devices are set by the T1-16S operating system. These devices are read only for user.
 - (2) Devices marked as (down) are set in the ERROR mode. Therefore these devices cannot be used in the user program.
 - (3) Devices marked as (alarm) are set in the normal operation mode. These devices can be used in the user program.

6. Programming Information

Device/ register	Name	Function
S010	System ROM error (down)	ON at error state
S011	System RAM error (down)	ON at error state
S012	Program memory error (down)	ON at error state
S013	EEPROM error (down)	ON at error state
S014	–	Reserved
S015	–	Reserved
S016	–	Reserved
S017	–	Reserved
S018	–	Reserved
S019	–	Reserved
S01A	–	Reserved
S01B	–	Reserved
S01C	–	Reserved
S01D	–	Reserved
S01E	–	Reserved
S01F	Watchdog timer error (down)	ON at error state
S020	–	Reserved
S021	I/O mismatch (down)	ON at error state
S022	–	Reserved
S023	–	Reserved
S024	–	Reserved
S025	–	Reserved
S026	–	Reserved
S027	–	Reserved
S028	–	Reserved
S029	–	Reserved
S02A	–	Reserved
S02B	–	Reserved
S02C	–	Reserved
S02D	–	Reserved
S02E	–	Reserved
S02F	–	Reserved



- (1) These devices are set by the T1-16S operating system. These devices are read only for user.
- (2) Devices marked as (down) are set in the ERROR mode. Therefore these devices cannot be used in the user program.

6. Programming Information

Device/ register	Name	Function
S030	Program error	ON at error state (related to SW06)
S031	Scan time over (down)	ON when the scan time exceeds 200 ms
S032	–	Reserved
S033	–	Reserved
S034	–	Reserved
S035	–	Reserved
S036	–	Reserved
S037	–	Reserved
S038	–	Reserved
S039	–	Reserved
S03A	–	Reserved
S03B	–	Reserved
S03C	–	Reserved
S03D	–	Reserved
S03E	–	Reserved
S03F	–	Reserved
S040	Timing relay 0.1 s	OFF 0.05 s / ON 0.05 s (0.1 s interval)
S041	Timing relay 0.2 s	OFF 0.1 s / ON 0.1 s (0.2 s interval)
S042	Timing relay 0.4 s	OFF 0.2 s / ON 0.2 s (0.4 s interval)
S043	Timing relay 0.8 s	OFF 0.4 s / ON 0.4 s (0.8 s interval)
S044	Timing relay 1.0 s	OFF 0.5 s / ON 0.5 s (1.0 s interval)
S045	Timing relay 2.0 s	OFF 1.0 s / ON 1.0 s (2.0 s interval)
S046	Timing relay 4.0 s	OFF 2.0 s / ON 2.0 s (4.0 s interval)
S047	Timing relay 8.0 s	OFF 4.0 s / ON 4.0 s (8.0 s interval)
S048	–	Reserved
S049	–	Reserved
S04A	–	Reserved
S04B	–	Reserved
S04C	–	Reserved
S04D	–	Reserved
S04E	Always OFF	Always OFF
S04F	Always ON	Always ON

All OFF at the
beginning of
RUN mode



- (1) These devices are set by the T1-16S operating system. These devices are read only for user.
- (2) Devices marked as (down) are set in the ERROR mode. Therefore these devices cannot be used in the user program.

6. Programming Information

Device/ register	Name	Function
S050	CF (carry flag)	Used for instructions which manipulate carry
S051	ERF (instruction error flag)	ON when instruction execution error is occurred (related to alarm flags of SW06)
S052	–	Reserved
S053	–	Reserved
S054	–	Reserved
S055	–	Reserved
S056	–	Reserved
S057	–	Reserved
S058	–	Reserved
S059	–	Reserved
S05A	–	Reserved
S05B	–	Reserved
S05C	–	Reserved
S05D	–	Reserved
S05E	–	Reserved
S05F	–	Reserved
S060	Illegal instruction (down)	ON when illegal instruction is detected
S061	–	Reserved
S062	–	Reserved
S063	–	Reserved
S064	Boundary error (alarm)	ON when illegal address is designated by indirect addressing (operation continued)
S065	–	Reserved
S066	–	Reserved
S067	–	Reserved
S068	Division error (alarm)	ON when error occurs in division instruction (operation continued)
S069	BCD data error (alarm)	ON when BCD data error has detected in BCD operation instructions (operation continued)
S06A	Table operation error (alarm)	ON when table size error has detected in table operation instructions (operation continued) (T1S only)
S06B	Encode error (alarm)	ON when error occurs in encode instruction (operation continued)
S06C	–	Reserved
S06D	–	Reserved
S06E	–	Reserved
S06F	–	Reserved



- (1) Devices marked as (down) are set in the ERROR mode. Therefore these devices cannot be used in the user program.
- (2) CF, ERF and devices marked as (alarm) can be reset by the user program.

6. Programming Information

Device/ register	Name	Function	
SW07	Clock/calendar (Year)	Lower 2 digits of the calendar year (01, 02, ...)	They are stored in the lower 8 bits by BCD code
SW08	Clock/calendar (Month)	Month (01, 02, ... 12)	
SW09	Clock/calendar (Day)	Day (01, 02, ... 31)	
SW10	Clock/calendar (Hour)	Hour (00, 01, ... 59)	
SW11	Clock/calendar (Minute)	Minute (00, 01, ... 59)	
SW12	Clock/calendar (Second)	Second (00, 01, ... 59)	
SW13	Clock/calendar (Week)	Day of the week (Sun = 00, Mon = 01, ... Sat = 06)	
SW14	–	Reserved	
SW15	Peripheral support priority	Bit 8 (S158) is used to select peripheral support priority	
SW16	Mode of special input functions	Used to select the special input functions	
SW17	Input filter constant	Used to set the input filter constant	
SW18	Preset values for high speed counter	Used to set the preset values for high speed counters	
SW19			
SW20			
SW21			
SW22	Count values for high speed counter	Present count values of the high speed counters are stored	
SW23			
SW24	High speed counter control flags	Control flags for the high speed counters	
SW25	–	Reserved	
SW26	Mode of special output functions	Used to select the special output functions	
SW27	Special output control flags	Control flags for the pulse/PWM output	
SW28	Special output frequency setting	Output frequency setting for the pulse/PWM output	
SW29	PWM output duty setting	Pulse duty setting for the PWM output	
SW30	Analog setting value 1	Input value of the analog setting adjuster V0	
SW31	Analog setting value 2	Input value of the analog setting adjuster V1	
SW32	–	Reserved	
SW33	–	Reserved	
SW34	TL-F10 send data	TOSLINE-F10 transmission data (send to master)	
SW35	TL-F10 receive data	TOSLINE-F10 transmission data (receive from master)	
SW36	PRG port station address	Used to set the programmer port station address (1 to 32)	
SW37	PRG port parity	Used to set the programmer port parity (0=none, 1=odd)	
SW38	PRG port response delay	Used to set the programmer port response delay time (0 to 30: 0 to 300ms)	



- (1) These devices are set by the T1-16S operating system. These devices are read only for user.
- (2) Devices marked as (down) are set in the ERROR mode. Therefore these devices cannot be used in the user program.

6. Programming Information

Device/ register	Name	Function
S390	Timer interrupt execution status	ON during execution
S391	I/O interrupt #1 execution status	ON during execution
S392	I/O interrupt #2 execution status	ON during execution
S393	I/O interrupt #3 execution status	ON during execution
S394	I/O interrupt #4 execution status	ON during execution
S395	–	Reserved
S396	–	Reserved
S397	–	Reserved
S398	–	Reserved
S399	–	Reserved
S39A	–	Reserved
S39B	–	Reserved
S39C	–	Reserved
S39D	–	Reserved
S39E	–	Reserved
S39F	–	Reserved
S400	–	Reserved
S401	HOLD device	ON during HOLD mode (setting by user program is also available)
S402	–	Reserved
S403	–	Reserved
S404	–	Reserved
S405	–	Reserved
S406	–	Reserved
S407	–	Reserved
S408	–	Reserved
S409	–	Reserved
S40A	–	Reserved
S40B	–	Reserved
S40C	–	Reserved
S40D	–	Reserved
S40E	–	Reserved
S40F	–	Reserved

6. Programming Information

Device/ register	Name	Function
SW41	Sub-program #1 execution status	Bit 0 (S410) is ON during the sub-program #1 is executed
SW42	–	Reserved
SW43	–	Reserved
SW44	–	Reserved
SW45	–	Reserved
SW46	–	Reserved
SW47	–	Reserved
SW48	–	Reserved
SW49	–	Reserved
SW50	–	Reserved
SW51	–	Reserved
SW52	–	Reserved
SW53	–	Reserved
SW54	Basic unit I/O LED display mode	Used to display the selected I/O module status (0 = Basic unit, 1 to 8 = I/O module slot 0 to 7, 9 and 10 = TOSLINE-F10)
SW55	Number of EEPROM write data	Used to set the number of data registers to be saved in the EEPROM (0 to 2048, initial value is 2048)
SW56	RS-485 port operation mode	Used to set the RS-485 port operation mode (0 = Computer link, 1 = Data link, 2 = Free ASCII, 3 = Inverter connection)
SW57	RS-485 port response delay	Used to set the RS-485 port response delay time (0 to 30: 0 to 300ms)
SW58	RS-485 port Free ASCII flags	Used for the RS-485 port Free ASCII function
SW59	–	Reserved
SW60	–	Reserved
SW61	–	Reserved
SW62	–	Reserved
SW63	–	Reserved



- (1) For details of SW54, refer to section 1.5.1.
- (2) For details of SW55, refer to section 5.2.
- (3) For details of SW56 through SW58, refer to the Communication function manual.

6. Programming Information

6.2 Index modification

When registers are used as operands of instructions, the method of directly designating the register address as shown in Example 1) below is called 'direct addressing'.

As opposed to this, the method of indirectly designating the register by combination with the contents of the index register (I, J, or K) as shown in Example 2) below is called 'indirect addressing'. In particular, in this case, since the address is modified using an index register, this is called 'index modification'.

Example 1)

—[RW10 MOV D1000]—

Data transfer instruction
Transfer data of RW10 to D1000

Example 2)

—[RW10 MOV D0000]—
 I J

Data transfer instruction (with index modification)
Transfer data of RW(10 + I) to D(0000 + J)
(If I = 3 and J = 200, the data of RW13 is transferred to D0200)

There are 3 types of index register, I, J and K. Each type processes 16-bit integers (-32768 to 32767). There are no particular differences in function between these 3 types of index register.

There is no special instruction for substituting values in these index registers. These are designated as destination of data transfer instructions, etc.

—[00064 MOV I]— (substitutes 64 in index register I)
—[D0035 MOV J]— (substitutes the data of D0035 in index register J)
—[RW20 + 00030 → K]— (substitutes the result of addition in index register K)



- (1) The index modification is available for RW, T, C and D registers.
- (2) If index registers are used as a double-length register, only the combinations JxI and KxJ are allowed.

6. Programming Information

The followings are examples of index modifications.

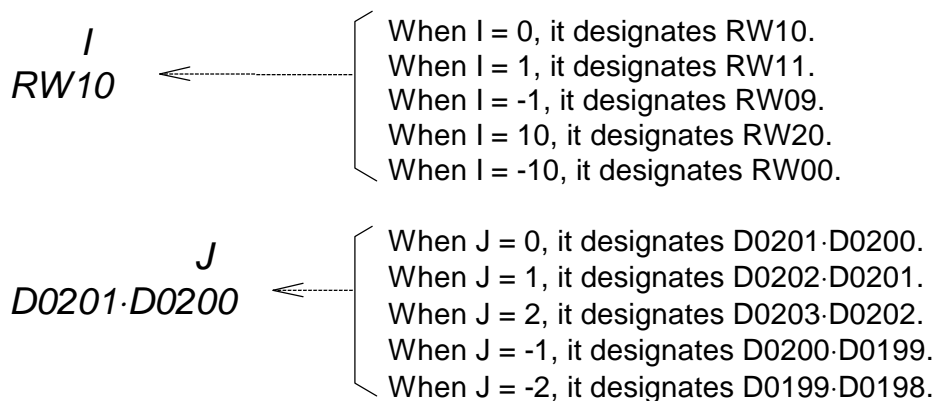

CAUTION

Be careful that the registers do not exceed the address range by the index modification. The address range is not checked by the T1-16S.



NOTE

Substitutions of values into index registers and index modifications can be used any times in a program. Normally, the program will be easier to see if a value substitution into an index register is positioned immediately before the index modification.

6. Programming Information

6.3 Real-time clock/calendar (Enhanced model only)

The T1-16S enhanced model is equipped with the real-time clock/calendar for year, month, day, day of the week, hour, minute, and second. These data are stored in the special registers SW07 to SW13 by 2-digit BCD format as follows.

Register	Function	Data
SW07	Year	1999 = H0099, 2000 = H0000, 2001 = H0001, 2002 = H0002 ...
SW08	Month	Jan. = H0001, Feb. = H0002, Mar. = H0003, ... Dec. = H0012
SW09	Day	1st = H0001, 2nd = H0002, 3rd = H0003, ... 31st = H0031
SW10	Hour	H0000, H0001, H0002, ... H0022, H0023
SW11	Minute	H0000, H0001, H0002, ... H0058, H0059
SW12	Second	H0000, H0001, H0002, ... H0058, H0059
SW13	Week	Sun. = H0000, Mon. = H0001, Tue. = H0002, ... Sat. = H0006

Program example:

In the following circuit, output Y030 turns ON for 1 minute at every Sunday 6 pm.

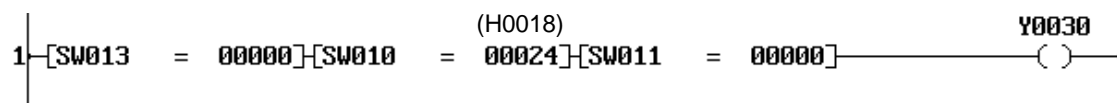

Clock/calendar back up:

The clock/calendar continues updating even while the power to the T1-16S is off by built-in capacitor and by the optional battery (CR2032) if used. Its back-up period is as follows.

Environment temperature	Expected value		Guarantee value	
	Capacitor	Battery	Capacitor	Battery
Under 30 °C (86 °F)	2 hours	2 year	1 hours	1 year
Over 30 °C (86 °F)	1 hours	1 year	30 minutes	6 months

As shown in the table, it is recommended to use the optional battery when the real-time clock/calendar function is used.

In the T1-16S, the validity of the clock/calendar is checked. If the data is not valid by excess power off period, special relay S00A is set to ON. Therefore, when the clock/calendar is used, it is recommended to check the status of S00A in the user program.

Setting the clock/calendar:

To set the clock/calendar data, the following 2 ways are available. In both cases, the week data is automatically calculated.

- (1) Setting the clock/calendar data on the system information screen of the programming tool.
- (2) Using the Calendar Set instruction (CLND) in the user program.

6. Programming Information

6.4 I/O allocation

The external input signals are allocated to the external input devices/registers (X/XW).
The external output signals are allocated to the external output devices/registers (Y/YW).

The register numbers of the external input and output registers are consecutive. Thus one register number can be assigned for either input or output.

As for the T1-16S basic unit, I/O allocation is fixed as follows.

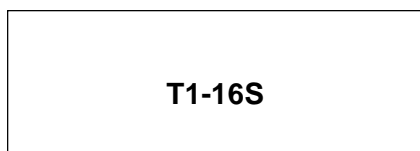

Inputs: 8 points (X000 - X007)

Outputs: 8 points (Y020 - Y027)

X000 --- X007 Y020---- Y027

Any operations for the I/O allocation are not required if only the T1-16S basic unit is used.

However, if the I/O modules are used with the T1-16S, the I/O allocation operation is necessary. Refer to the separate manual "T1-16S User's Manual - I/O Modules -".

6. Programming Information

Internally, the T1-16S has information called 'I/O allocation table' in its memory. This I/O allocation table shows the correspondence between I/O hardware and software, i.e. register/device.

The contents of the I/O allocation table are as follows.

Unit	Slot	I/O type
0	PU	
	0	X+Y 4W
	1	
	2	
	3	
	4	
	5	
	6	
1	0	
	1	
	2	
	3	
	4	
	5	
	6	
	7	

← PU slot must be blank
 ← Slot 0 is for basic unit (XW00, XW01, YW02 and YW03 are assigned internally)
 ← Slots 1 to 7 of unit 0 are not used (must be blank)
 ← These slots are for I/O modules

The T1-16S operating system automatically sets the I/O type 'X+Y 4W' on the slot 0 at unit 0 position when the memory clear is executed for the T1-16S.

When the T1-16S program is developed in off-line, the above I/O allocation table should be set before programming. For this operation (called manual I/O allocation), refer to the programming tool manual.



- (1) Unit base address setting function is not supported by the T1-16S. Do not use this function with the T1-16S. It will causes malfunction.
- (2) When the TOSLINE-F10 station module FR112M is used, allocate it at the end of the I/O modules.

6. Programming Information

6.5 T1-16S memory mode setting

The program capacity of the T1-16S is 8 k steps. However, user can set the T1-16S's program capacity to 4 k steps. It is called the T1-16S's memory mode.

That is, the T1-16S has two memory modes, 8 k mode and 4 k mode.

In the 4 k mode, on-line program changes become available, although the program capacity is limited to 4 k steps. Refer to section 6.9 for the on-line debug support functions.

To set the T1-16S's memory mode, write 4 k or 8 k on the Program Size Setting of the System Parameters using the programming tool. Then execute the EEPROM write command.

6. Programming Information

6.6 User program configuration

A group of instructions for achieving the PLC-based control system is called 'user program'. The T1-16S has 8 k steps capacity for storing the user program. A 'step' is the minimum unit, which composes an instruction. Number of steps required for one instruction is depending on the type of instruction. Refer to section 7.1.

The figure below shows the T1-16S's memory configuration.

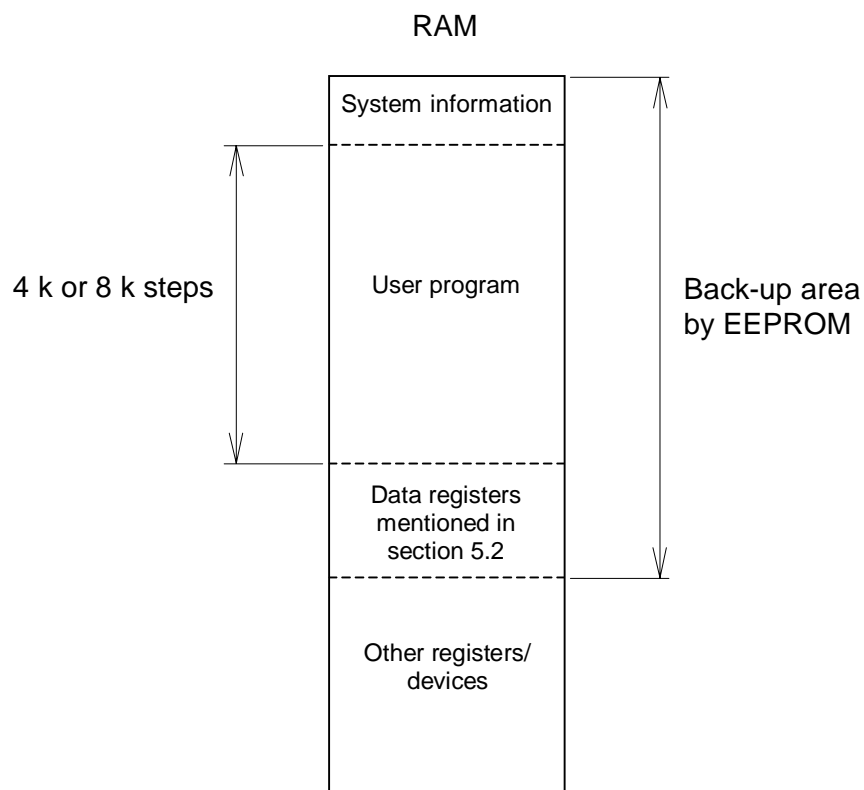

For conditions of transfer between RAM and EEPROM, see section 5.2.

6. Programming Information

System information

System information is the area which stores execution control parameters. The following contents are included in the system information.

- (1) Machine parameters (hardware type, memory type)
- (2) User program information (program ID, system comments, number of steps used)
- (3) Passwords
- (4) Retentive register area information
- (5) T1S program memory mode, 4 k steps or 8 k steps
- (6) Execution control parameters (scan mode, timer interrupt interval)
- (7) Station number setting for programmer port (T1), or RS-485 port communication parameters (Enhanced model)
- (8) I/O allocation table
- (9) Input force table

The system information is stored in the built-in EEPROM. Therefore, when this information is modified, the EEPROM write operation is necessary. Otherwise, these are over-written by original EEPROM contents at the next initial load timing.

User program

The T1-16S has a capacity of 8 k steps of the user program.

The user program is stored by each program types as shown in the following diagram, and is managed by units called blocks in each program types.

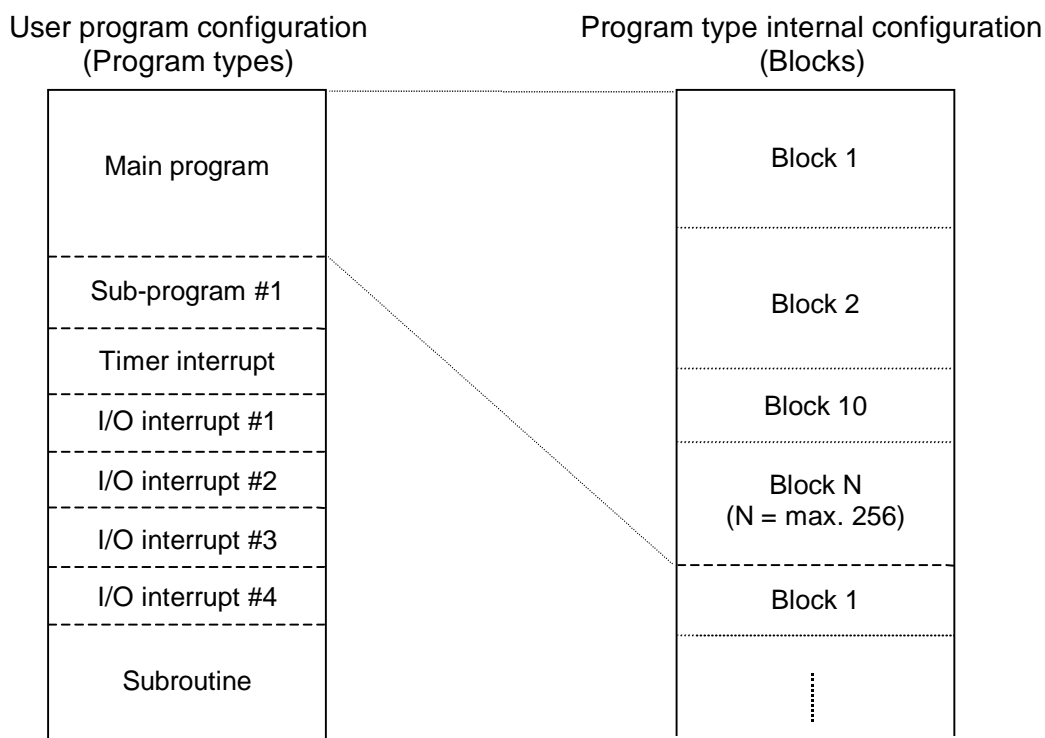

6. Programming Information

In the user program, the main program is the core. The scan operation explained in section 5.3 is for the main program. The operation of other program types are explained in the following sections.

The following 8 program types are supported by the T1-16S.

- (1) Main program
- (2) Sub-program #1
- (3) Timer interrupt program
- (4) I/O interrupt program #1
- (5) I/O interrupt program #2
- (6) I/O interrupt program #3
- (7) I/O interrupt program #4
- (8) Subroutine

The blocks are just separators of the program, and have no effect on the program execution. However, by dividing the user program into some blocks, the program becomes easy to understand. The block numbers need not be consecutive.

In each program type and block, there is no limit of program capacity. The only limit is the total capacity.

6.6.1 Main program

The main program is the core of the user program. It is executed once in each scan.

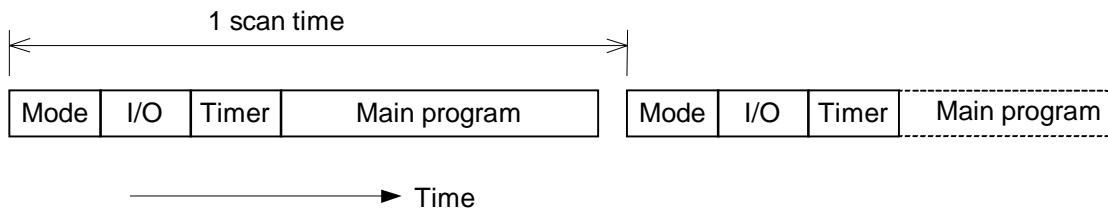

In the above figure,

Mode means the mode control operation

I/O means the I/O update processing

Timer means the timer up date processing

Main program means the main program execution

the self-diagnostic check and peripheral support are omitted in this figure.

The end of the main program is recognized by the END instruction.

Although instructions may be present after the END instruction, these portions will not be executed.

6. Programming Information

6.6.2 Sub-program #1

If the sub-program #1 is programmed, it is executed once at the beginning of the first scan (before main program execution).

Therefore, the sub-program #1 can be used to set the initial value into the registers. The sub-program #1 is called the initial program.

The figure below shows the first scan operation.

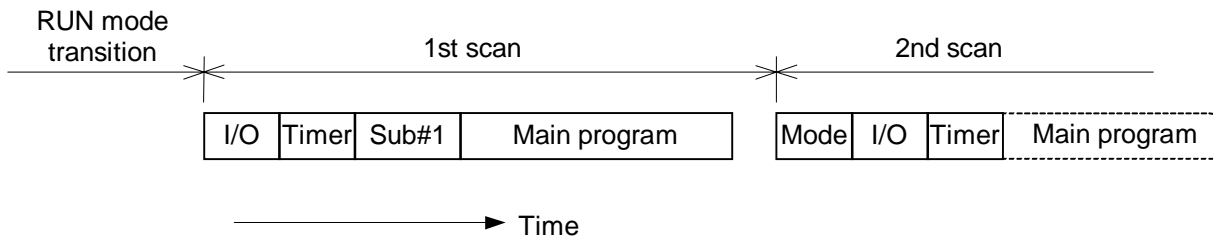

The end of the sub-program #1 is recognized by the END instruction.

6.6.3 Timer interrupt program

The timer interrupt is the highest priority task. It is executed cyclically with a user specified interval, with suspending other operation.

The interrupt interval is set in the system information. (5 to 1000 ms, 5 ms units)

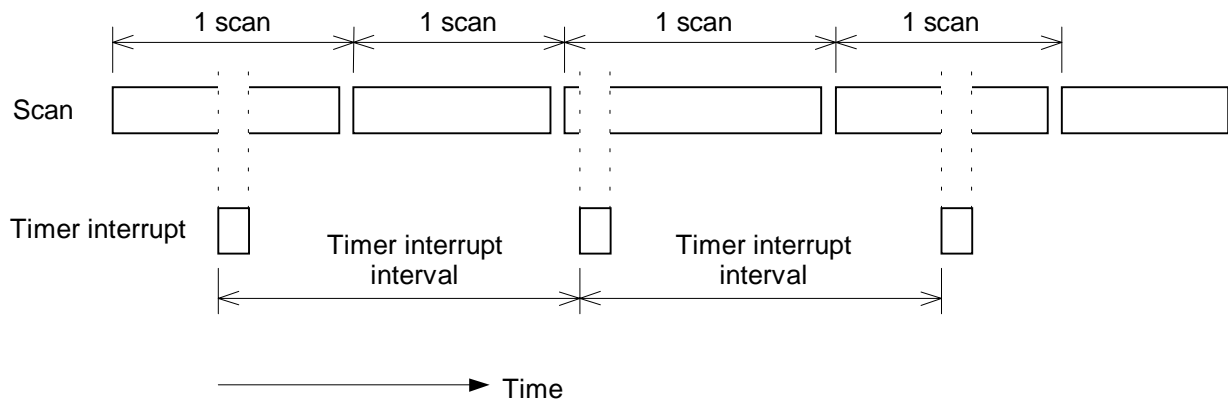

The end of the timer interrupt is recognized by the IRET instruction.

6. Programming Information

6.6.4 I/O interrupt programs

The I/O interrupt program is also the highest priority task. It is executed immediately when the interrupt factor is generated, with suspending other operation.

The following 4 types I/O interrupt programs are supported in the T1/T1S.

(1) I/O interrupt #1

The I/O interrupt #1 is used with the high speed counter function. When the count value reaches the preset value, etc., the I/O interrupt #1 is activated immediately with suspending other operation. The end of the I/O interrupt #1 is recognized by the IRET instruction. For detailed information, refer to section 8.3.

(2) I/O interrupt #2

The I/O interrupt #2 is also used with the high speed counter function. Refer to section 8.3 for details.

(3) I/O interrupt #3

The I/O interrupt #3 is used with the interrupt input function. When the state of the interrupt input is changed from OFF to ON (or ON to OFF), the I/O interrupt #3 is activated immediately with suspending other operation. The end of the I/O interrupt #3 is also recognized by the IRET instruction. For detailed information, refer to section 8.4.

(4) I/O interrupt #4

The I/O interrupt #4 is also used with the interrupt input function. Refer to section 8.4 for details.

If an interrupt factor is generated while other interrupt program is executing (including the timer interrupt), the interrupt factor is held. Then it will be activated after finishing the other interrupt program execution.

If two or more interrupt factors are generated at the same time, the priority is as follows.

Timer > I/O #1 > I/O #2 > I/O #3 > I/O #4

6. Programming Information

6.6.5 Subroutines

In the program type 'Subroutine', The following number of subroutines can be programmed.

The T1-16S supports up to 256 subroutines.

The subroutine is not a independent program. It is called from other program types (main program, sub-program, interrupt program) and from other subroutines.

One subroutine is started with the SUBR instruction, and ended by the RET instruction.

It is necessary to assign a subroutine number to the SUBR instruction. The available subroutine numbers are 0 to 255.

—[SUBR (000)]—
 ↑
 Subroutine number

The RET instruction has no subroutine number.

The instruction that calls a registered subroutine is the CALL instruction. The CALL instruction has the subroutine number to be called.

—[CALL N.000]—
 ↑
 Subroutine number

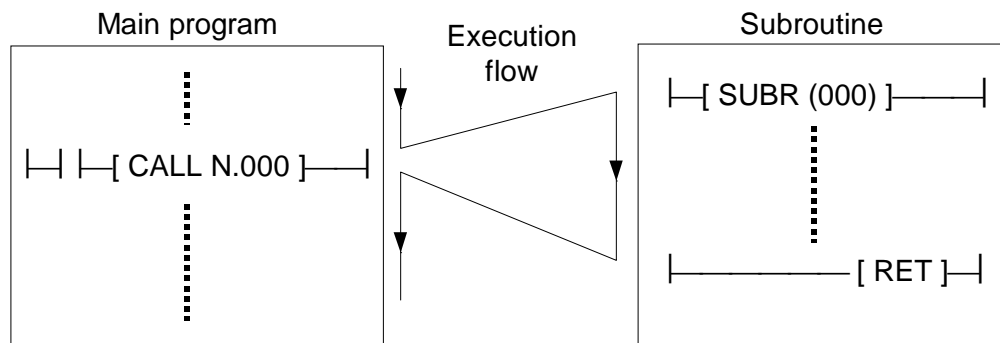

- NOTE**
- (1) Multiple subroutines can be programmed in a block. However, one subroutine in one block is recommended.
 - (2) From the inside of a subroutine, other subroutines can be called (nesting). Its allowable level is up to 3 levels.

6. Programming Information

6.7 Programming language

The programming language of the T1-16S is 'ladder diagram'. Ladder diagram is a language, which composes program using relay symbols as a base in an image similar to a hard-wired relay sequence. In the T1/T1S, in order to achieve an efficient data-processing program, ladder diagram which are combinations of relay symbols and function blocks are used.

The ladder diagram program is constructed by units called 'rung'. A rung is defined as one network which is connected each other.

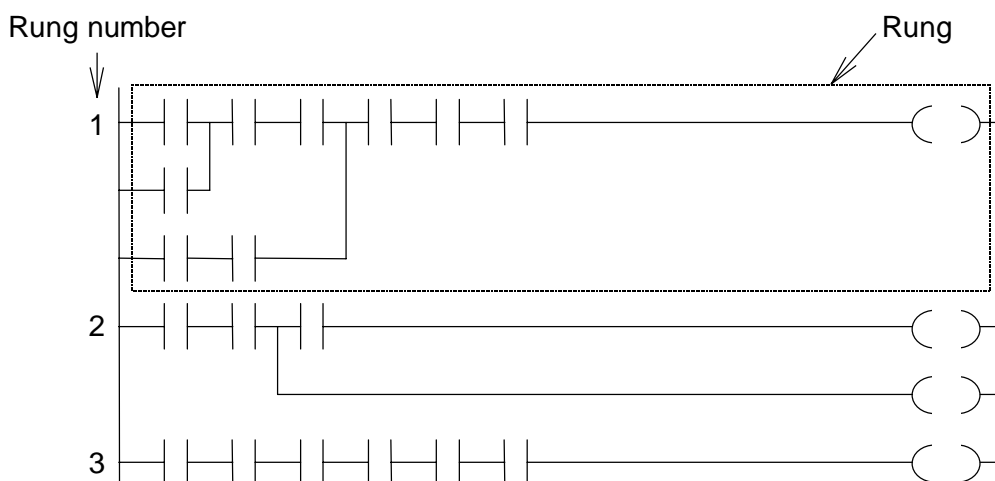

The rung numbers are a series of numbers (decimal number) starting from 1, and cannot be skipped. There is no limit to the number of rungs.

The size of any one rung is limited to 11 lines \times 12 columns.

An example of a ladder diagram program is shown below.



When X005 is ON or the data of D0100 is greater than 200, Y027 comes ON. Y027 stays ON even if X005 is OFF and the data of D0100 is 200 or less. Y027 will come OFF when X006 comes ON.

6. Programming Information

6.8 Program execution sequence

The instructions execution sequence is shown below.

- (1) They are executed in the sequence from block 1 through the final block, which contains the END instruction (or IRET in an interrupt program).
- (2) They are executed in the sequence from rung 1 through the final rung in a block (or the END instruction).
- (3) They are executed according to the following rules in any one rung.

- ① When there is no vertical connection, they are executed from left to right.

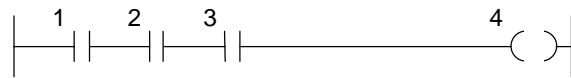

- ② When there is an OR connection, the OR logic portion is executed first.

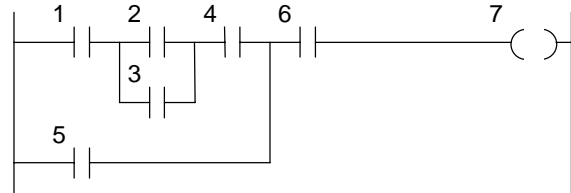

- ③ When there is a branch, they are executed in the order from the upper line to the lower line.

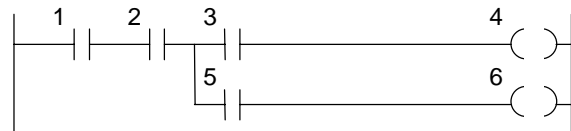

- ④ A combination of ② and ③ above.

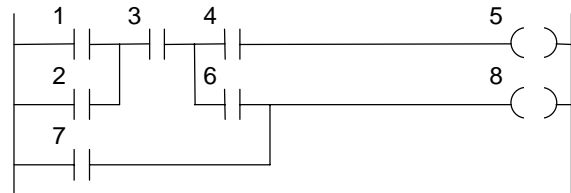

The instructions execution sequence in which function instructions are included also follows the above rules. However, for program execution control instructions, such as jumps (JCS), loops (FOR-NEXT), subroutines (CALL-SUBR-RET), it will depend the specifications of each instruction.

6. Programming Information

6.9 On-line debug support functions

The following on-line (during RUN) functions are supported in the T1-16S for effective program debugging.

On-line function	4 k mode	8 k mode
Force function	Yes	Yes
Sampling trace function	Yes	Yes
Changing timer /counter preset value	Yes	Yes
Changing constant operand of function instruction	Yes	Yes
Changing device directly	Yes	Yes
Program changing in edit mode	Yes	No
EEPROM write command	Yes	Yes

NOTE



Refer to section 6.5 for 4 k/8 k mode.

Force function

Two types of force functions are available, input force and coil force.

The input force is used to disable the external input signals. When an external input device is designated as forced input, the ON/OFF state of the device can be changed manually by using the data setting function of the programming tool, regardless of the corresponding external signal state. The input force designation is available for the external input devices (X).

The coil force is used to disable the coil instruction. When a coil instruction on the program is designated as forced coil, the ON/OFF state of the coil device can be changed manually by using the data setting function of the programming tool, regardless of the coil circuit execution status.

On the programming tool, the forced input and forced coil are expressed as follows.

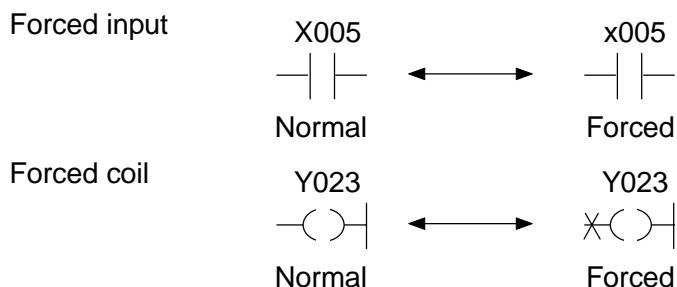

NOTE



If EEPROM write operation is executed with remaining the force designation, the force designation is also saved into the built-in EEPROM. Because the force function is debugging function, release all force designation before executing the EEPROM write operation. The force batch release command is available when the T1-16S is in HALT mode.

6. Programming Information

Sampling trace function

The sampling trace function collects the status of specified devices or register at every specified sampling timing. The collected data can be displayed on the programmer (T-PDS) screen in the format of timing chart (for devices) or trend graph (for register). The minimum sampling timing is the T1-16S's scan cycle. This function is useful for program debugging and troubleshooting.

T1-16S	
Sampling target	Devices (up to 8) and Registers (up to 3)
Sampling capacity	256 times

The collected data is stored in the T1-16S internal buffer. The buffer works as a ring buffer, and latest collected data can be displayed.

The sampling start/stop condition (arm condition) and the collection timing (trigger condition) can be specified by status changing of devices.

For detailed key operations for arm/trigger conditions setting on the T-PDS, refer to the manual for T-PDS.

T-PDS screen example of device timing chart

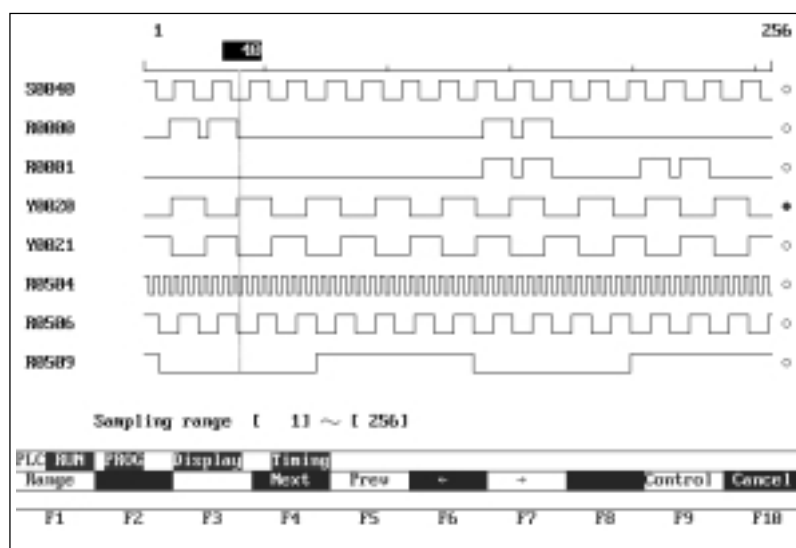

- NOTE**
- (1) On the T-PDS, select '3 registers + 8 devices' as the sampling type.
 - (2) As the arm and trigger conditions, register values cannot be used.
 - (3) The After times setting is not effective for the T1-16S.

6. Programming Information

Timer/counter preset value (constant data) changing

The preset value (constant data) of timer or counter instruction can be changed in on-line (during RUN) by using the programming tool.

Function instruction constant operand changing

The constant operand of function instruction can be changed in on-line (during RUN) by using the programming tool.

Device changing

The device of contact or coil instruction can be changed in on-line (during RUN) by using the programming tool.

On-line program changing

When the T1S's memory mode is 4 k mode, the program can be changed using normal edit mode. (rung by rung)

In the on-line program changing, it is not allowed to change the number or order of the following instructions.

END, MCS, MCR, JCS, JCR, FOR, NEXT, CALL, SUBR, RET, IRET



The above on-line functions are performed on the RAM memory. Therefore, when program has been changed, execute the EEPROM write operation before turning off power. Otherwise, program stored in the EEPROM will be overwritten.

On-line EEPROM write

The EEPROM write is possible in on-line (during RUN) as well as in HALT mode.

In the on-line EEPROM write, user data is not written into the EEPROM.

During this operation, the T1-16S's scan time becomes longer. However, as it has the time limit per scan, the T1-16S's control operation is not stopped.

6. Programming Information

6.10 Password protection

The T1-16S has the password function to protect the user program and data from unauthorized operations.

There are four levels of protection. Accordingly, three levels of passwords can be registered to control the protection levels.

These passwords are stored in the built-in EEPROM. Therefore, if you entered, changed or cleared the passwords, the EEPROM write operation is necessary.

The outline of the protection levels are shown below. For details, refer to the manual for the programming tool.

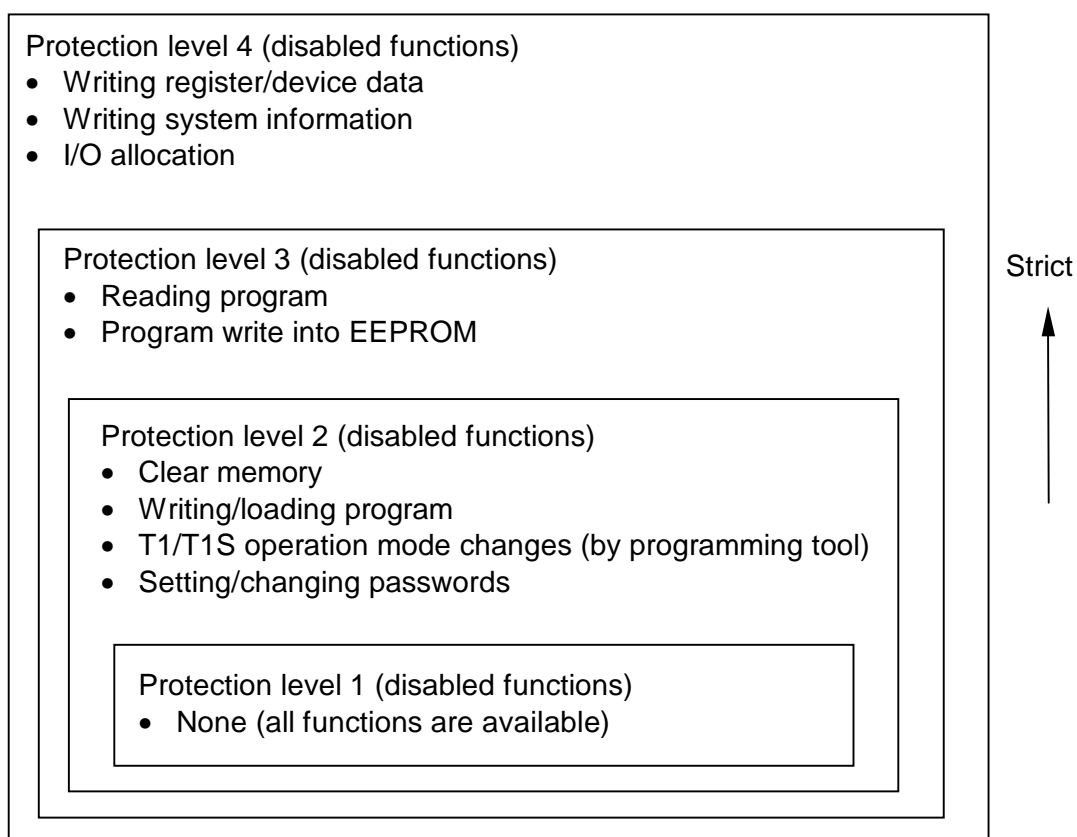

When the level 1, 2 and 3 passwords are registered, the T1-16S will be started as protection level 4. In this state, for example, entering the level 2 password changes the protection level to 2.



When you use the password function, do not forget the level 1 password. Otherwise, you cannot change/release the registered passwords.

Section 7

Instructions

- 7.1 *List of instructions, 106*
- 7.2 *Instruction specifications, 116*

7. Instructions

7.1 List of instructions

The T1-16S has 21 types of basic ladder instructions and 97 types of function instructions as listed below. The specifications of each instruction will be described in detail later.

The tables listing these instructions are provided as a quick reference. (Note: In the following table, italic character means operand, i.e. register, device or constant value.)

Basic ladder instructions

FUN No.	Name	Expression	Function	Steps	Speed (μs)	Page
–	NO contact	A 	NO (normally open) contact of device <i>A</i> .	1	1.4 - 3.3	117
–	NC contact	A /	NC (normally closed) contact of device <i>A</i> .	1	1.4 - 3.3	118
–	Transitional contact (rising)	A /	Turns ON output for 1 scan when input changes from OFF to ON.	1	3.0	119
–	Transitional contact (falling)	A \	Turns ON output for 1 scan when input changes from ON to OFF.	1	3.0	120
–	Coil	A -()	Relay coil of device <i>A</i> .	1	2.3	121
–	Forced coil	A *()	Forced coil of device <i>A</i> . State of device <i>A</i> is retained regardless of the input state.	1	2.3	122
–	Inverter		Inverts the input state.	1	1.4 - 3.3	123
–	Invert coil	A -(I)	Stores the inverse state of input into device <i>A</i> .	1	2.3	124
–	Positive pulse contact	A - P	Turns ON output for 1 scan when input is ON and device <i>A</i> changes from OFF to ON.	1		125
–	Negative pulse contact	A - N	Turns ON output for 1 scan when input is ON and device <i>A</i> changes from ON to OFF.	1		126
–	Positive pulse coil	A -(P)	Turns ON device <i>A</i> for 1 scan when input changes from OFF to ON.	1		127
–	Negative pulse coil	A -(N)	Turns ON device <i>A</i> for 1 scan when input changes from ON to OFF.	1		128
–	ON delay timer	-[<i>A</i> TON <i>B</i>]-	Turns ON output when the time specified by <i>A</i> has elapsed after the input came ON. <i>B</i> is a timer register.	2	12.6	129
–	OFF delay timer	-[<i>A</i> TOF <i>B</i>]-	Turns OFF output when the time specified by <i>A</i> has elapsed after the input came OFF. <i>B</i> is a timer register.	2	12.8	130
–	Single shot timer	-[<i>A</i> SS <i>B</i>]-	Turns ON output for the time specified by <i>A</i> when the input comes ON. <i>B</i> is a timer register.	2	13.0	131

7. Instructions

Basic ladder instructions (continued)

FUN No.	Name	Expression	Function	Steps	Speed (μs)	Page
–	Counter	$G \begin{array}{ c } \hline \text{CNT} \\ \hline \end{array} \begin{array}{ c } \hline Q \\ \hline \end{array}$ $E \begin{array}{ c } \hline A \ B \\ \hline \end{array}$	Counts the number of cycles the count input (C) comes ON while the enable input (E) is ON, and turns ON output (Q) when the count reaches to the value specified by A. B is a counter register.	2	22.6	132
–	Master control set	$\text{---}[\text{MCS}]\text{---}$	Turns OFF power rail between MCS and MCR when MCS input is OFF.	1	3.75 (in a pair)	133
–	Master control reset	$\text{---}[\text{MCR}]\text{---}$		1		
–	Jump control set	$\text{---}[\text{JCS}]\text{---}$	Jumps from JCS to JCR when JCS input is ON.	1	2.75 (in a pair)	134
–	Jump control reset	$\text{---}[\text{JCR}]\text{---}$		1		
–	End	$\text{---}[\text{END}]\text{---}$	Indicates end of main program or sub-program.	1	1.4	135

Data transfer instructions

FUN No.	Name	Expression	Function	Steps	Speed (μs)	Page
018	Data transfer	$\text{---}[A \text{ MOV } B]\text{---}$	Transfers data of A to B.	3	4.2	136
019	Double-word data transfer	$\text{---}[A+1:A \text{ DMOV } B+1:B]\text{---}$	Transfers double-word data of A+1:A to B+1:B.	3	7.2	137
020	Invert transfer	$\text{---}[A \text{ NOT } B]\text{---}$	Transfers bit-inverted data of A to B.	3	4.6	138
022	Data exchange	$\text{---}[A \text{ XCHG } B]\text{---}$	Exchanges data of A with B.	3	6.5	139
024	Table initialize	$\text{---}[A \text{ TINZ } (n) \ B]\text{---}$	Transfers data of A to n registers starting with B.	3		140
025	Table transfer	$\text{---}[A \text{ TMOV } (n) \ B]\text{---}$	Transfers data of n registers starting with A to n registers starting with B.	3		141
026	Table invert transfer	$\text{---}[A \text{ TNOT } (n) \ B]\text{---}$	Transfers bit-inverted data of n registers starting with A to n registers starting with B.	3		142
090	Multiplexer	$\text{---}[A \text{ MPX } (n) \ B \rightarrow C]\text{---}$	Transfers data from the register specified by B in the table, size n starting with A, to C.	5	70.6	176
091	Demultiplexer	$\text{---}[A \text{ DPX } (n) \ B \rightarrow C]\text{---}$	Transfers data from A to the register specified by B in the table, size n starting with C.	5	71.5	177

7. Instructions

Arithmetic operations

FUN No.	Name	Expression	Function	Steps	Speed (μ s)	Page
027	Addition	$-[A + B \rightarrow C]-$	Adds data of A and B , and stores the result in C .	4	6.5	143
028	Subtraction	$-[A - B \rightarrow C]-$	Subtracts data of B from A , and stores the result in C .	4	6.5	144
029	Multiplication	$-[A * B \rightarrow C+1 \cdot C]-$	Multiplies data of A and B , and stores the result in double-length register $C+1 \cdot C$.	4	8.8	145
030	Division	$-[A / B \rightarrow C]-$	Divides data of A by B , and stores the quotient in C and the remainder in $C+1$.	4	9.7	146
031	Double-word addition	$-[A+1 \cdot A D+ B+1 \cdot B \rightarrow C+1 \cdot C]-$	Adds data of $A+1 \cdot A$ and $B+1 \cdot B$, and stores the result in $C+1 \cdot C$.	4	11.6	147
032	Double-word subtraction	$-[A+1 \cdot A D- B+1 \cdot B \rightarrow C+1 \cdot C]-$	Subtracts data of $B+1 \cdot B$ from $A+1 \cdot A$, and stores the result in $C+1 \cdot C$.	4	11.7	148
035	Addition with carry	$-[A +C B \rightarrow C]-$	Adds data of A , B and the carry, and stores the result in C . The carry flag changes according to the result.	4	9.7	149
036	Subtraction with carry	$-[A -C B \rightarrow C]-$	Subtracts data of B and the carry from A , and stores the result in C . The carry flag changes according to the result.	4	9.7	150
039	Unsigned multiplication	$-[A U* B \rightarrow C+1 \cdot C]-$	Multiplies data of A and B , and stores the result in double-length register $C+1 \cdot C$. (Unsigned integer operation)	4		151
040	Unsigned division	$-[A U/ B \rightarrow C]-$	Divides data of A by B , and stores the quotient in C and the remainder in $C+1$. (Unsigned integer operation)	4		152
041	Unsigned double/single division	$-[A+1 \cdot A DIV B \rightarrow C]-$	Divides data of $A+1 \cdot A$ by B , and stores the quotient in C and the remainder in $C+1$. (Unsigned integer operation)	4	15.3	153
043	Increment	$-[+1 A]-$	Increments data of A by 1.	2	4.6	154
044	Decrement	$[-1 A]-$	Decrements data of A by 1.	2	4.6	155

7. Instructions

Logical operations

FUN No.	Name	Expression	Function	Steps	Speed (μs)	Page
048	AND	$\neg[A \text{ AND } B \rightarrow C]$	Finds logical AND of A and B , and stores it in C .	4	5.7	156
050	OR	$\neg[A \text{ OR } B \rightarrow C]$	Finds logical OR of A and B , and stores it in C .	4	5.7	157
052	Exclusive OR	$\neg[A \text{ EOR } B \rightarrow C]$	Finds logical exclusive OR of A and B , and stores it in C .	4	5.7	158
064	Bit test	$\neg[A \text{ TEST } B]$	Turns ON output if logical AND of A and B is not 0.	3	5.0	163

Shift operations

FUN No.	Name	Expression	Function	Steps	Speed (μs)	Page
068	1 bit shift right	$\neg[\text{SHR1 } A]$	Shifts data of A 1 bit to the right (LSB direction). The carry flag changes according to the result.	2	6.8	164
069	1 bit shift left	$\neg[\text{SHL1 } A]$	Shifts data of A 1 bit to the left (MSB direction). The carry flag changes according to the result.	2	6.8	165
070	n bit shift right	$\neg[A \text{ SHR } n \rightarrow B]$	Shifts data of A n bits to the right (LSB direction) and stores the result in B . The carry flag changes according to the result.	4	10.2	166
071	n bit shift left	$\neg[A \text{ SHL } n \rightarrow B]$	Shifts data of A n bits to the left (MSB direction) and stores the result in B . The carry flag changes according to the result.	4	10.2	167
074	Shift register	$\begin{array}{c} D \\ S \\ E \end{array} \left[\begin{array}{c} \text{SR} \\ (n) \\ A \end{array} \right] \text{---} Q$	When shift input (S) comes ON, shifts the data of specified shift register 1 bit to the left, and stores data input (D) state into A . This operation is enabled while enable input (E) is ON. The carry flag changes according to the result. Shift register: n devices starting with device A .	3	65.9 - 76.2	168
075	Bi-directional shift register	$\begin{array}{c} D \\ S \\ E \\ L \end{array} \left[\begin{array}{c} \text{DSR} \\ (n) \\ A \end{array} \right] \text{---} Q$	When shift input (S) comes ON, shifts the data of specified shift register 1 bit to the left or to the right depending on direction input (L). This operation is enabled while enable input (E) is ON. The carry flag changes according to the result. Shift register: n devices starting with device A . Direction: Left when L is ON, right when L is OFF	3	69.0 - 79.3	170

7. Instructions

Rotate operations

FUN No.	Name	Expression	Function	Steps	Speed (μ s)	Page
078	1 bit rotate right	$-\text{[RTR1 } A\text{-]}$	Rotates data of A 1 bit to the right (LSB direction). The carry flag changes according to the result.	2	6.8	172
079	1 bit rotate left	$-\text{[RTL1 } A\text{-]}$	Rotates data of A 1 bit to the left (MSB direction). The carry flag changes according to the result.	2	6.8	173
080	n bit rotate right	$-\text{[A RTR } n \rightarrow B\text{-]}$	Rotates data of A n bits to the right (LSB direction) and stores the result in B . The carry flag changes according to the result.	4	10.2	174
081	n bit rotate left	$-\text{[A RTL } n \rightarrow B\text{-]}$	Rotates data of A n bits to the left (MSB direction) and stores the result in B . The carry flag changes according to the result.	4	10.2	175

Compare instructions

FUN No.	Name	Expression	Function	Steps	Speed (μ s)	Page
096	Greater than	$-\text{[A > B]-}$	Turns ON output if $A > B$.	3	6.1	178
097	Greater than or equal	$-\text{[A >= B]-}$	Turns ON output if $A \geq B$.	3	5.3	179
098	Equal	$-\text{[A = B]-}$	Turns ON output if $A = B$.	3	5.0	180
099	Not equal	$-\text{[A <> B]-}$	Turns ON output if $A \neq B$.	3	5.0	181
100	Less than	$-\text{[A < B]-}$	Turns ON output if $A < B$.	3	6.1	182
101	Less than or equal	$-\text{[A <= B]-}$	Turns ON output if $A \leq B$.	3	5.3	183
102	Double-word greater than	$-\text{[A+1.A D> B+1.B]-}$	Turns ON output if $A+1.A > B+1.B$.	3	6.1	184
103	Double-word greater than or equal	$-\text{[A+1.A D>= B+1.B]-}$	Turns ON output if $A+1.A \geq B+1.B$.	3	5.3	185
104	Double-word equal	$-\text{[A+1.A D= B+1.B]-}$	Turns ON output if $A+1.A = B+1.B$.	3	5.0	186
105	Double-word not equal	$-\text{[A+1.A D<> B+1.B]-}$	Turns ON output if $A+1.A \neq B+1.B$.	3	5.0	187
106	Double-word less than	$-\text{[A+1.A D< B+1.B]-}$	Turns ON output if $A+1.A < B+1.B$.	3	6.1	188
107	Double-word less than or equal	$-\text{[A+1.A D<= B+1.B]-}$	Turns ON output if $A+1.A \leq B+1.B$.	3	5.3	189

7. Instructions

Compare instructions (continued)

FUN No.	Name	Expression	Function	Steps	Speed (μs)	Page
108	Unsigned greater than	$\neg[A \text{ U} > B]$	Turns ON output if $A > B$. (Unsigned integer compare)	3		190
109	Unsigned greater than or equal	$\neg[A \text{ U} \geq B]$	Turns ON output if $A \geq B$. (Unsigned integer compare)	3		191
110	Unsigned equal	$\neg[A \text{ U} = B]$	Turns ON output if $A = B$. (Unsigned integer compare)	3		192
111	Unsigned not equal	$\neg[A \text{ U} <> B]$	Turns ON output if $A \neq B$. (Unsigned integer compare)	3		193
112	Unsigned less than	$\neg[A \text{ U} < B]$	Turns ON output if $A < B$. (Unsigned integer compare)	3		194
113	Unsigned less than or equal	$\neg[A \text{ U} \leq B]$	Turns ON output if $A \leq B$. (Unsigned integer compare)	3		195

Special data processing

FUN No.	Name	Expression	Function	Steps	Speed (μs)	Page
114	Device/register set	$\neg[\text{SET } A]$	If A is a device: Sets device A to ON. ----- If A is a register: Stores HFFFF in register A .	2	4.2	196
115	Device/register reset	$\neg[\text{RST } A]$	If A is a device: Resets device A to OFF. ----- If A is a register: Stores 0 in register A .	2	4.2	197
118	Set carry	$\neg[\text{SETC}]$	Sets the carry flag to ON.	1	4.2	198
119	Reset carry	$\neg[\text{RSTC}]$	Resets the carry flag to OFF.	1	4.2	199
120	Encode	$\neg[A \text{ ENC } (n) B]$	Finds the uppermost ON bit position in the bit file of size 2^n bits starting with register A , and stores it in B .	4	57.0 - 141.4	200
121	Decode	$\neg[A \text{ DEC } (n) B]$	In the bit file of size 2^n bits starting with register B , sets ON the bit position indicated by lower n bits of A , and resets OFF all other bits.	4	69.5 - 99.1	201
122	Bit count	$\neg[A \text{ BC } B]$	Counts the number of ON bits of A and stores it in B .	3		202
147	Flip-flop	$\begin{array}{c} \text{S} \text{---} \text{ F/F } \text{---} \text{Q} \\ \text{R} \text{---} \text{ A } \end{array}$	Sets ON device A when set input (S) is ON, and resets OFF device A when reset input (R) is ON. (Reset takes priority)	2	26.7	215
149	Up-down counter	$\begin{array}{c} \text{U} \text{---} \text{ U/D } \text{---} \text{Q} \\ \text{C} \text{---} \\ \text{E} \text{---} \text{ A } \end{array}$	While enable input (E) is ON, counts up or down the number of cycles the count input (C) comes ON, depending on the up/down select input (U). Up when U is ON, down when U is OFF.	2	30.1	216

7. Instructions

Program control instructions

FUN No.	Name	Expression	Function	Steps	Speed (μs)	Page	
128	Subroutine call	-[CALL N. <i>n</i>]-	Calls the subroutine number <i>n</i> .	2	21.0	203	
129	Subroutine return	-[RET]-	Indicates the end of a subroutine.	1	(in a pair)	204	
132	FOR	-[FOR <i>n</i>]-	When the input of FOR is ON, executes the segment from FOR to NEXT the number of times specified by <i>n</i> .	2	22.0 (in a pair)	205	
133	NEXT	-[NEXT]-		1		206	
137	Subroutine entry	-[SUBR (<i>n</i>)]-	Indicates the start of the subroutine number <i>n</i> .	2	included in CALL	207	
140	Enable interrupt	-[EI]-	Enables execution of interrupt program.	1	27.6 (in a pair)	208	
141	Disable interrupt	-[DI]-	Disables execution of interrupt program.	1		209	
142	Interrupt return	-[IRET]-	Indicates the end of an interrupt program.	1	1.4	210	
143	Watchdog timer reset	-[WDT <i>n</i>]-	Extends the scan time over detection time.	2	16.1	211	
144	Step sequence initialize	-[STIZ (<i>n</i>) A]-	Resets OFF the <i>n</i> devices stating with A, and sets ON A.	These configure a series of step sequence	3	59.9 - 65.0	212
145	Step sequence input	-[STIN A]-	Turns ON output if input is ON and A is ON.		2	27.0	213
146	Step sequence output	-[STOT A]-	When input is ON, resets OFF the devices of STIN on the same rung, and sets ON A.		2	27.0 - 119.0	214

RAS

FUN No.	Name	Expression	Function	Steps	Speed (μs)	Page
154	Set calendar	-[A CLND]-	Sets 6 registers data starting with A into clock/calendar.	2		217
155	Calendar operation	-[A CLDS B]-	Calculates difference between present date & time and past date & time stored in 6 registers starting with A, and stores the result in 6 registers starting with B.	3		218

7. Instructions

Functions

FUN No.	Name	Expression	Function	Steps	Speed (μ s)	Page
056	Moving average	-[A MAVE (n) B \rightarrow C]-	Calculates the average value of latest n scan values of A , and stores the result in C .	5		159
061	Digital filter	-[A DFL B \rightarrow C]-	Filters the value of A by filter constant specified by B , and stores the result in C .	4		160
156	Pre-derivative real PID	-[A PID3 B \rightarrow C]-	Performs PID control. (pre-derivative real PID algorithm) Process value (PV): A Set value (SV): $A+1$ PID parameters: B and after Manipulation value (MV): C	4	85.0 - 428.0	219
160	Upper limit	-[A UL B \rightarrow C]-	Upper limits the value of A by B , and stores the result in C .	4		224
161	Lower limit	-[A LL B \rightarrow C]-	Lower limits the value of A by B , and stores the result in C .	4		225
162	Maximum value	-[A MAX (n) B]-	Finds the maximum value of n registers data starting with A , and stores the value in C and the pointer in $C+1$.	4		226
163	Minimum value	-[A MIN (n) B]-	Finds the minimum value of n registers data starting with A , and stores the value in C and the pointer in $C+1$.	4		227
164	Average value	-[A AVE (n) B]-	Calculates the average value of n registers data starting with A , and stores the result in C .	4		228
165	Function generator	-[A FG (n) B \rightarrow C]-	Finds $f(x)$ for given $x=A$, and stores it in C . The function $f(x)$ is defined by parameters stored in a table $2 \times n$ registers starting with B .	5	77.7 - 142.1	229

7. Instructions

Conversion instructions

FUN No.	Name	Expression	Function	Steps	Speed (μ s)	Page
062	Hex to ASCII conversion	-[A HTOA (n) B]-	Converts the hexadecimal data of n words starting with A into ASCII characters, and stores them in $n \times 2$ registers starting with B .	4		161
063	ASCII to Hex conversion	-[A ATOH (n) B]-	Converts the ASCII characters stored in n registers starting with A into hexadecimal data, and stores them in $n/2$ registers starting with B .	4		162
180	Absolute value	-[A ABS B]-	Stores the absolute value of A in B .	3	5.0	231
182	2's complement	-[A NEG B]-	Stores the 2's complement value of A in B .	3	4.6	232
183	Double-word 2's complement	-[A+1·A DNEG B+1·B]-	Stores the 2's complement value of $A+1·A$ in $B+1·B$.	3	4.6	233
185	7-segment decode	-[A 7SEG B]-	Converts lower 4 bits of A into 7-segment code, and stores it in B .	3	43.9	234
186	ASCII conversion	-[A ASC B]-	Converts the alphanumerics (max. 16 characters) of A into ASCII codes, and stores them in registers starting with B .	3 - 10	29.8 - 49.6	236
188	Binary conversion	-[A BIN B]-	Converts the BCD data in A into binary data, and stores it in B .	3	65.5	237
190	BCD conversion	-[A BCD B]-	Converts the binary data in A into BCD data, and stores it in B .	3	55.6	238

7. Instructions

Special I/O instructions

FUN No.	Name	Expression	Function	Steps	Speed (μ s)	Available	Page
235	Direct I/O	-[I/O (n) A]-	Performs the immediate block I/O transfer of n registers starting with A .	3	$20.7 + 21.3 \times n$	\checkmark *1	257
236	Expanded data transfer	-[A XFER $B \rightarrow C$]-	Writes data into the built-in EEPROM, or reads data from the EEPROM. The transfer source and destination are indirectly designated by A and C . The transfer register size is designated by B .	4	54.0 1w read - 7130 16w write	\checkmark	259

*1: Direct I/O instruction is effective only for the basic unit inputs/outputs.

*2: The expanded data transfer (XFER) instruction supports some special functions. It also supports the communication function. The execution speed shown in the above table is for the EEPROM read/write function. When the Inverter connection mode is selected, the execution speed of this instruction is typically 150 μ s (max. 500 μ s).



NOTE

The index modification is available for some instructions. The values in the execution speed column show the execution time without index modification.

If index modification is used, approx. 20 μ s is added per one indexed operand.

7. Instructions

7.2 Instruction specifications

The following pages in this section describe the detailed specifications of each instruction. On each page, the following items are explained.

Expression

Shows the operands required for the instruction as italic characters.

Function

Explains the functions of the instruction with referring the operands shown on the Expression box.

Execution condition

Shows the execution condition of the instruction and the instruction output status.

Operand

Shows available register, device or constant value for each operand. For constant operand, available value range is described. If the constant column is just marked (√), it means normal value range (-32768 to 32767 in 16-bit integer or -2147483648 to 2147483647 in 32-bit integer) is available.

Whether index modification for a register operand is usable or not is also shown for each operand.

Example

Explains the operation of the instruction by using a typical example.

Note

Explains supplementary information, limitations, etc. for the instruction.

7. Instructions

	NO contact
---	------------

Expression

A
Input  Output

Function

NO (normally open) contact of device A.

When the input is ON and the device A is ON, the output is turned ON.

Execution condition

Input	Operation	Output
OFF	Regardless of the state of device A	OFF
ON	When device A is OFF	OFF
	When device A is ON	ON

Operand

	Name	Device						Register								Constant	Index		
		X	Y	R	S	T	C	XW	YW	RW	SW	T	C	D	I			J	K
A	Device	√	√	√	√	√	√												

Example

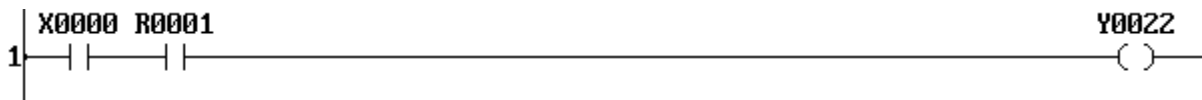

Coil Y022 comes ON when the devices X000 and R001 are both ON.

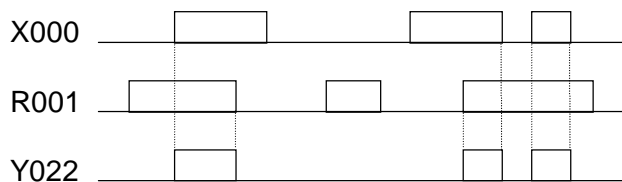

7. Instructions



NC contact

Expression

Input \overline{A} Output

Function

NC (normally closed) contact of device *A*.

When the input is ON and the device *A* is OFF, the output is turned ON.

Execution condition

Input	Operation	Output
OFF	Regardless of the state of device <i>A</i>	OFF
ON	When device <i>A</i> is OFF	ON
	When device <i>A</i> is ON	OFF

Operand

	Name	Device						Register								Constant	Index		
		X	Y	R	S	T	C	XW	YW	RW	SW	T	C	D	I			J	K
<i>A</i>	Device	√	√	√	√	√	√												

Example

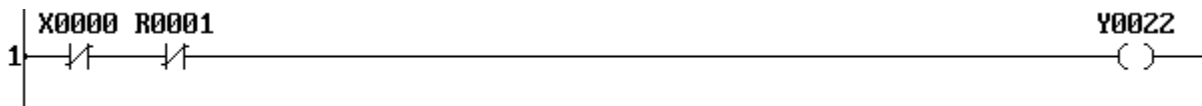

Coil Y022 comes ON when the devices X000 and R001 are both OFF.

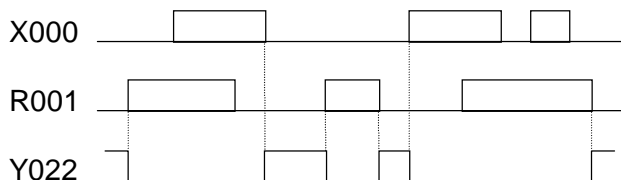

7. Instructions



Transitional contact (Rising edge)

Expression

Input  Output

Function

When the input at last scan is OFF and the input at this scan is ON, the output is turned ON. This instruction is used to detect the input changing from OFF to ON.

Execution condition

Input	Operation	Output
OFF	Regardless of the input state at last scan	OFF
ON	When the input state at last scan is OFF	ON
	When the input state at last scan is ON	OFF

Operand

No operand is required.







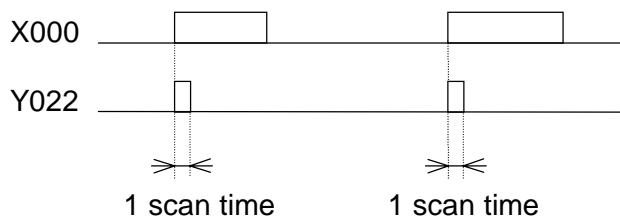

Example



Coil Y022 comes ON for only 1 scan when the device X000 comes ON.



Note

- In case of T1, the maximum usable number in a program is 512. ( and  total)
- In case of T1S, the maximum usable number in a program is 2048. (       total)

7. Instructions



Transitional contact (Falling edge)

Expression

Input  Output

Function

When the input at last scan is ON and the input at this scan is OFF, the output is turned ON. This instruction is used to detect the input changing from ON to OFF.

Execution condition

Input	Operation	Output
OFF	When the input state at last scan is OFF	OFF
	When the input state at last scan is ON	ON
ON	Regardless of the input state at last scan	OFF

Operand

No operand is required.



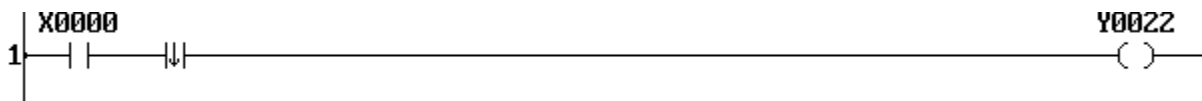



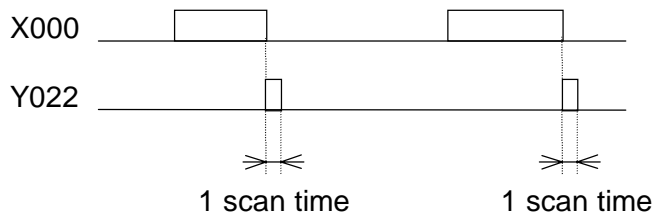

Example



Coil Y022 comes ON for only 1 scan when the device X000 comes OFF.



Note

- In case of T1, the maximum usable number in a program is 512. ( and  total)
- In case of T1S, the maximum usable number in a program is 2048. (       total)

7. Instructions

-()H | Coil

Expression

$\overset{A}{\text{Input}} \text{-()H}$

Function

Relay coil of device A.

When the input is ON, the device A is set to ON.

Execution condition

Input	Operation	Output
OFF	Sets device A to OFF	-
ON	Sets device A to ON	-

Operand

	Name	Device						Register										Constant	Index	
		X	Y	R	S	T.	C.	XW	YW	RW	SW	T	C	D	I	J	K			
A	Device		√	√	√															

Example

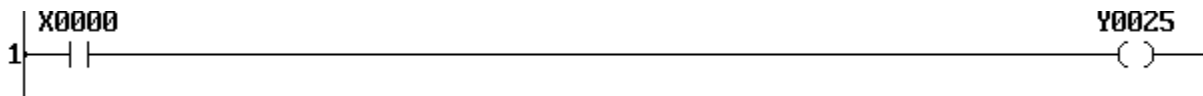

Coil Y025 comes ON when the devices X000 is ON.



7. Instructions

⌘()H | Forced coil

Expression

Input A
⌘()H

Function

Regardless of the input state the state of device A is retained.

Execution condition

Input	Operation	Output
OFF	No operation	–
ON	No operation	–

Operand

	Name	Device						Register									Constant	Index	
		X	Y	R	S	T	C	XW	YW	RW	SW	T	C	D	I	J			K
A	Device		√	√	√														

Example

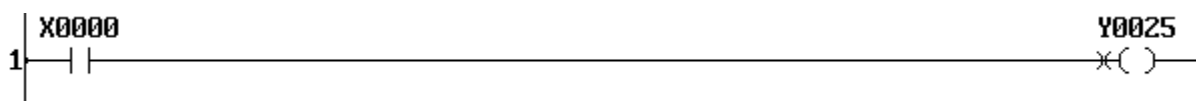

Device Y025 retains the preceding state regardless of the device X000 state.

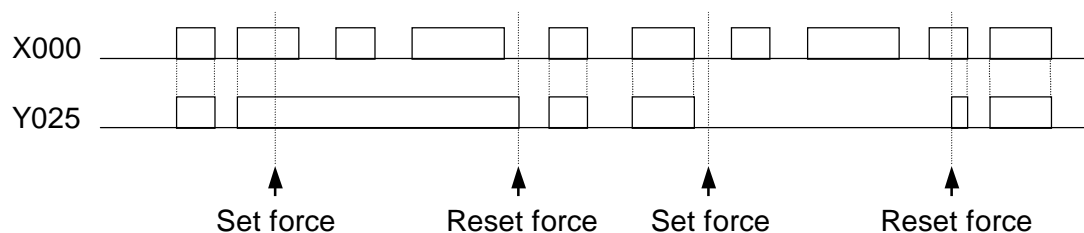

Note

- The forced coil is a debugging function. The state of a forced coil device can be set ON or OFF by the programming tool.

7. Instructions



Inverter

Expression

Input Output

Function

When the input is OFF, the output is turned ON, and when the input is ON, the output is turned OFF.

This instruction inverts the link state.

Execution condition

Input	Operation	Output
OFF	Inverts the input state	ON
ON	Inverts the input state	OFF

Operand

No operand is required.

Example

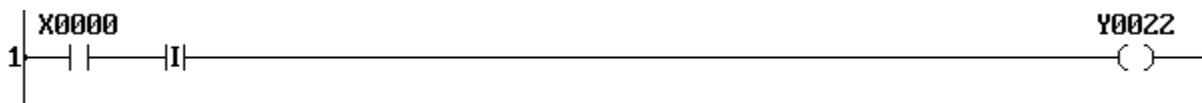

Y022 comes ON when X000 is OFF, and Y022 comes OFF when X000 is ON.

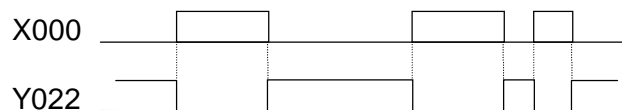

7. Instructions

-(I)-| Invert coil

Expression

Input $\overset{A}{-(I)-}$

Function

When the input is OFF, the device A is set to ON, and when the input is ON, the device A is set to OFF. This instruction inverts the input state and store it in the device A.

Execution condition

Input	Operation	Output
OFF	Sets device A to ON	-
ON	Sets device A to OFF	-

Operand

	Name	Device						Register								Constant	Index		
		X	Y	R	S	T	C.	XW	YW	RW	SW	T	C	D	I			J	K
A	Device		√	√	√														

Example

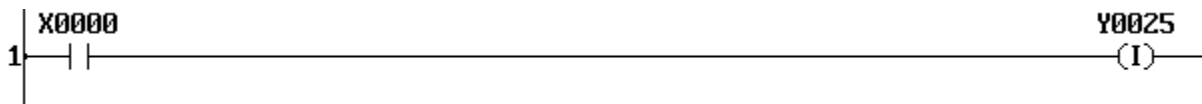

Y025 comes ON when X000 is OFF, and Y025 comes OFF when X000 is ON.



7. Instructions

	Positive pulse contact
--	------------------------

Expression

	A					
Input		Output				

Function

When the input is ON and the device *A* is changed from OFF to ON (OFF at last scan and ON at this scan), the output is turned ON.

This instruction is used to detect the device changing from OFF to ON.

Execution condition

Input	Operation	Output	
OFF	Regardless of the state of device <i>A</i>	OFF	
ON	State of device <i>A</i> is OFF	OFF	
	State of device <i>A</i> is ON	<i>A</i> is OFF at last scan	ON
		<i>A</i> is ON at last scan	OFF

Operand

	Name	Device						Register								Constant	Index		
		X	Y	R	S	T	C	XW	YW	RW	SW	T	C	D	I			J	K
A	Device	√	√	√	√	√	√												

Example

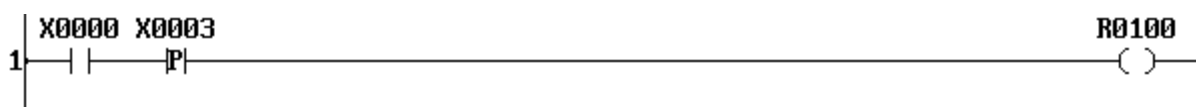

R100 comes ON for only 1 scan when X000 is ON and X003 changes to ON.

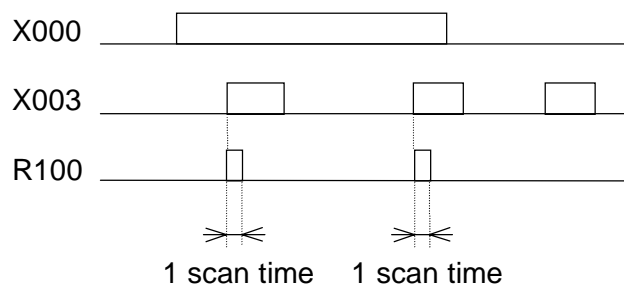

Note

- The maximum usable number in a program is 2048.
(total)

7. Instructions

 Negative pulse contact

Expression

Input \overline{A} Output

Function

When the input is ON and the device *A* is changed from ON to OFF (ON at last scan and OFF at this scan), the output is turned ON.

This instruction is used to detect the device changing from ON to OFF.

Execution condition

Input	Operation		Output
OFF	Regardless of the state of device <i>A</i>		OFF
ON	State of device <i>A</i> is OFF	<i>A</i> is OFF at last scan	OFF
		<i>A</i> is ON at last scan	ON
	State of device <i>A</i> is ON		OFF

Operand

	Name	Device						Register							Constant	Index			
		X	Y	R	S	T	C	XW	YW	RW	SW	T	C	D			I	J	K
A	Device	√	√	√	√	√	√												

Example



R100 comes ON for only 1 scan when X000 is ON and X003 changes to OFF.

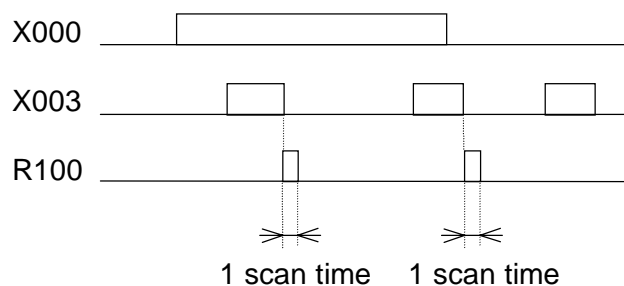

Note

- The maximum usable number in a program is 2048.
(\overline{A} \overline{V} \overline{P} \overline{N} $\overline{(P)}$ $\overline{(N)}$ total)

7. Instructions

-(P)-	Positive pulse coil
-------	---------------------

Expression

A	Input -(P)-
---	-------------

Function

When the input is changed from OFF to ON, the device A is set to ON for 1 scan time. This instruction is used to detect the input changing from OFF to ON.

Execution condition

Input	Operation	Output
OFF	Sets device A to OFF	-
ON	When the input at last scan is OFF, sets A to ON	-
	When the input at last scan is ON, sets A to OFF	-

Operand

A	Name	Device						Register								Constant	Index			
		X	Y	R	S	T	C	XW	YW	RW	SW	T	C	D	I			J	K	
A	Device		√	√	√															

Example

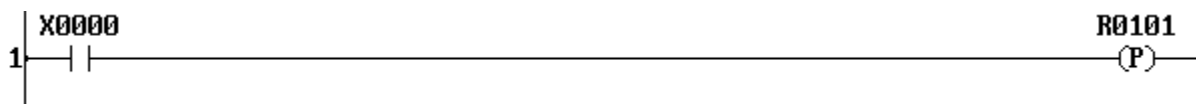

R101 comes ON for only 1 scan when X000 is changed from OFF to ON.

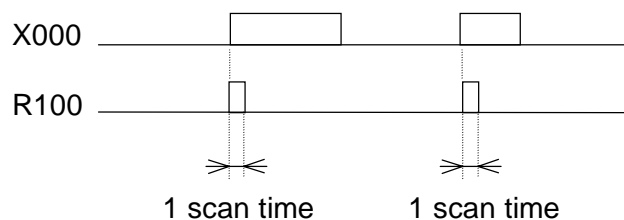

Note

- The maximum usable number in a program is 2048.
(-I)-(-V)-(-P)-(-N)-(-P)-(-N) total)

7. Instructions

$\neg(N)H$ Negative pulse coil

Expression

Input $\overset{A}{\neg(N)H}$

Function

When the input is changed from ON to OFF, the device A is set to ON for 1 scan time. This instruction is used to detect the input changing from ON to OFF.

Execution condition

Input	Operation	Output
OFF	When the input at last scan is OFF, sets A to OFF	–
	When the input at last scan is ON, sets A to ON	–
ON	Sets device A to OFF	–

Operand

	Name	Device						Register								Constant	Index			
		X	Y	R	S	T.	C.	XW	YW	RW	SW	T	C	D	I			J	K	
A	Device		√	√	√															

Example

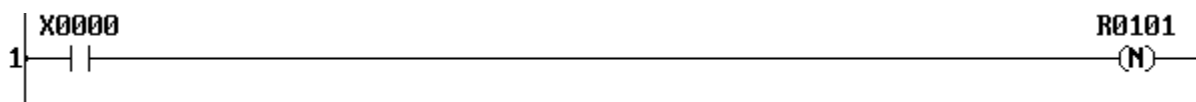

R101 comes ON for only 1 scan when X000 is changed from ON to OFF.

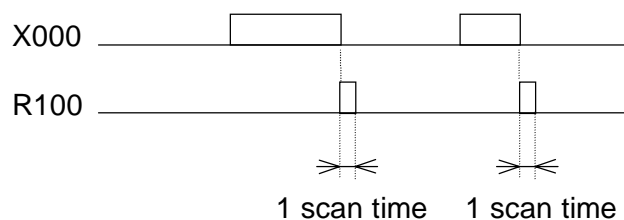

Note

- The maximum usable number in a program is 2048.
($\neg(N)H$ $\neg(V)H$ $\neg(P)H$ $\neg(N)H$ $\neg(P)H$ $\neg(N)H$ total)

7. Instructions

TON	ON delay timer
-----	----------------

Expression

Input —[A TON B]— Output

Function

When the input is changed from OFF to ON, timer updating for the timer register *B* is started. The elapsed time is stored in *B*. When the specified time by *A* has elapsed after the input came ON, the output and the timer device corresponding to *B* is turned ON. (Timer updating is stopped)

When the input is changed from ON to OFF, *B* is cleared to 0, and the output and the timer device are turned OFF.

The available data range for operand *A* is 0 to 32767.

Execution condition

Input	Operation	Output
OFF	No operation (timer is not updating)	OFF
ON	Elapsed time < preset time (timer is updating)	OFF
	Elapsed time ≥ preset time (timer is not updating)	ON

Operand

	Name	Device						Register								Constant	Index		
		X	Y	R	S	T	C	XW	YW	RW	SW	T	C	D	I			J	K
<i>A</i>	Preset time							√	√	√	√	√	√	√	√	√	√	0 - 32767	
<i>B</i>	Elapsed time											√							

Example

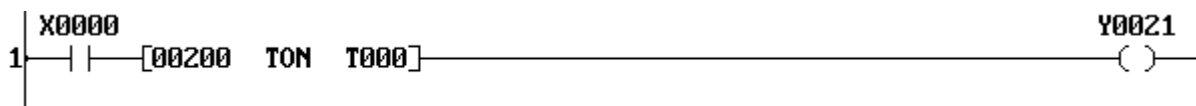

Y021 (and the timer device T.000) is turned ON 2 seconds after X000 came ON.

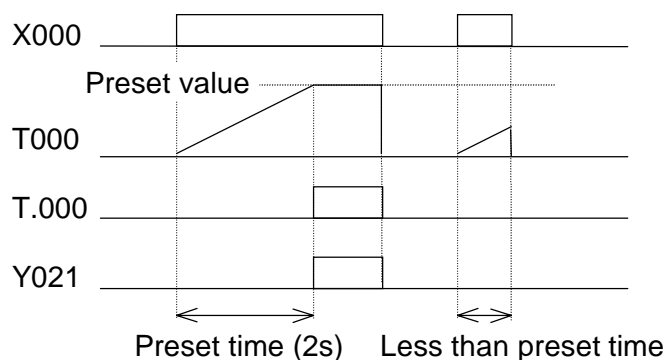

Note

- Time is set in 10 ms units for;
T1: T000 to T031 (0 to 327.67 s)
T1S: T000 to T063 (0 to 327.67 s)
- Time is set in 100 ms units for;
T1: T032 to T063 (0 to 3276.7 s)
T1S: T064 to T255 (0 to 3276.7 s)
- Multiple timer instructions (TON, TOF or SS) with the same timer register are not allowed.

7. Instructions

TOF OFF delay timer

Expression

Input —[A TOF B]— Output

Function

When the input is changed from OFF to ON, the output and the timer device corresponding to the timer register *B* are set to ON. When the input is changed from ON to OFF, timer updating for *B* is started. The elapsed time is stored in *B*. When the specified time by *A* has elapsed after the input came OFF, the output and the timer device are turned OFF. (Timer updating is stopped)

The available data range for operand *A* is 0 to 32767.

Execution condition

Input	Operation	Output
OFF	Elapsed time < preset time (timer is updating)	ON
	Elapsed time ≥ preset time (timer is not updating)	OFF
ON	No operation (timer is not updating)	ON

Operand

	Name	Device						Register							Constant	Index			
		X	Y	R	S	T	C	XW	YW	RW	SW	T	C	D			I	J	K
<i>A</i>	Preset time							√	√	√	√	√	√	√	√	√	√	0 - 32767	
<i>B</i>	Elapsed time											√							

Example

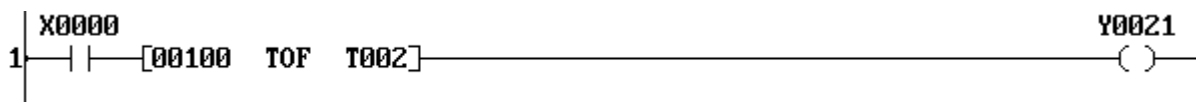

Y021 (and the timer device T.002) is turned OFF 1 second after X000 came OFF.

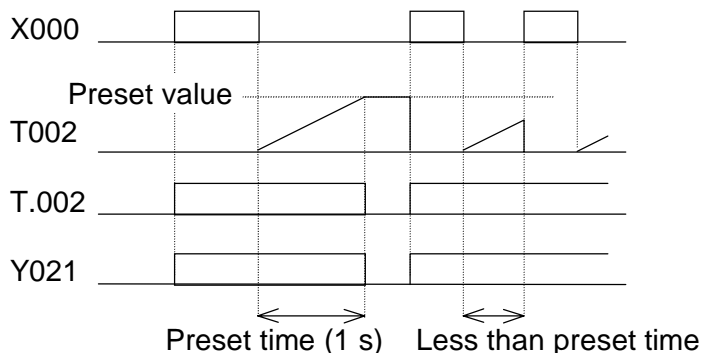

Note

- Time is set in 10 ms units for;
T1: T000 to T031 (0 to 327.67 s)
T1S: T000 to T063 (0 to 327.67 s)
- Time is set in 100 ms units for;
T1: T032 to T063 (0 to 3276.7 s)
T1S: T064 to T255 (0 to 3276.7 s)
- Multiple timer instructions (TON, TOF or SS) with the same timer register are not allowed.

7. Instructions

SS	Single shot timer
----	-------------------

Expression

Input —[A SS B]— Output

Function

When the input is changed from OFF to ON, the output and the timer device corresponding to the timer register *B* are set to ON, and timer updating for *B* is started. The elapsed time is stored in *B*. When the specified time by *A* has elapsed after the input came ON, the output and the timer device are turned OFF. (Timer updating is stopped)

The available data range for operand *A* is 0 to 32767.

Execution condition

Input	Operation	Output
OFF	Elapsed time < preset time (timer is updating)	ON
	Elapsed time ≥ preset time (timer is not updating)	OFF
ON	Elapsed time < preset time (timer is updating)	ON
	Elapsed time ≥ preset time (timer is not updating)	OFF

Operand

	Name	Device						Register										Constant	Index	
		X	Y	R	S	T	C	XW	YW	RW	SW	T	C	D	I	J	K			
A	Preset time							√	√	√	√	√	√	√	√	√	√	√	0 - 32767	
B	Elapsed time												√							

Example

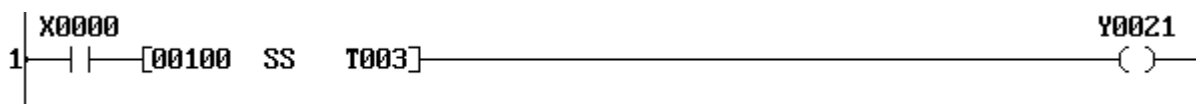

Y021 (and the timer device T.003) is turned OFF 1 second after X000 came ON.

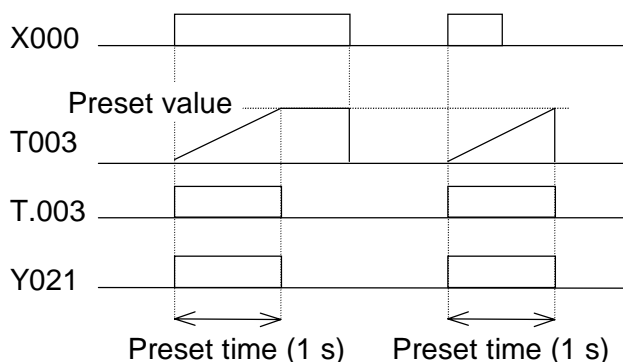

Note

- Time is set in 10 ms units for;
T1: T000 to T031 (0 to 327.67 s)
T1S: T000 to T063 (0 to 327.67 s)
- Time is set in 100 ms units for;
T1: T032 to T063 (0 to 3276.7 s)
T1S: T064 to T255 (0 to 3276.7 s)
- Multiple timer instructions (TON, TOF or SS) with the same timer register are not allowed.

7. Instructions

CNT	Counter
-----	---------

Expression

Count input	[C CNT Q]	Output
Enable input	[E A B]	

Function

While the enable input is ON, this instruction counts the number of the count input changes from OFF to ON. The count value is stored in the counter register *B*. When the count value reaches the set value *A*, the output and the counter device corresponding to *B* are turned ON. When the enable input comes OFF, *B* is cleared to 0 and the output and the counter device are turned OFF. The available data range for operand *A* is 0 to 65535.

Execution condition

Enable input	Operation	Output
OFF	No operation (<i>B</i> is cleared to 0)	OFF
ON	Count value (<i>B</i>) < set value (<i>A</i>)	OFF
	Count value (<i>B</i>) ≥ set value (<i>A</i>)	ON

Operand

	Name	Device						Register								Constant	Index		
		X	Y	R	S	T	C	XW	YW	RW	SW	T	C	D	I			J	K
<i>A</i>	Set value							√	√	√	√	√	√	√	√	√	√	0 - 65535	
<i>B</i>	Count value												√						

Example

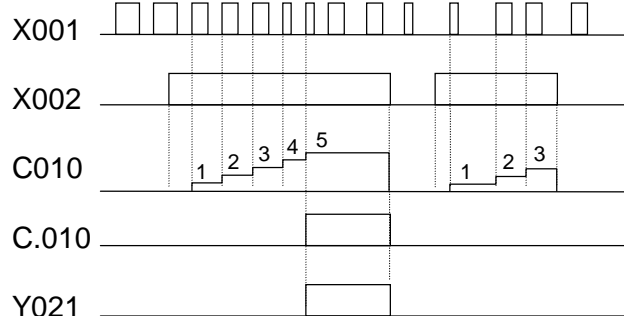

Note

- No transitional contact is required for the count input. The count input rising edge is detected by this instruction.
- For the count input, direct linking to a connecting point is not allowed. In this case, insert a dummy contact (always ON = S04F, etc.) just before the input. Refer to Note of Shift register FUN 074.
- Multiple counter instructions (CNT) with

7. Instructions

MCS MCR	Master control set / reset
------------	----------------------------

Expression

Input	
-------	--

Function

When the MCS input is ON, ordinary operation is performed. When the MCS input is OFF, the state of left power rail between MCS and MCR is turned OFF.

Execution condition

MCS input	Operation	Output
OFF	Sets OFF the left power rail until MCR	–
ON	Ordinary operation	–

Operand

No operand is required.

Example

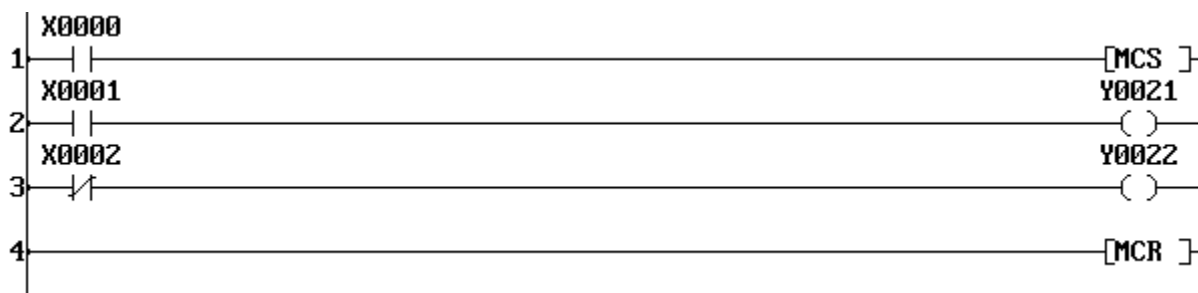

When X000 is OFF, Y021 and Y022 are turned OFF regardless of the states of X001 and X002.

Equivalent circuit

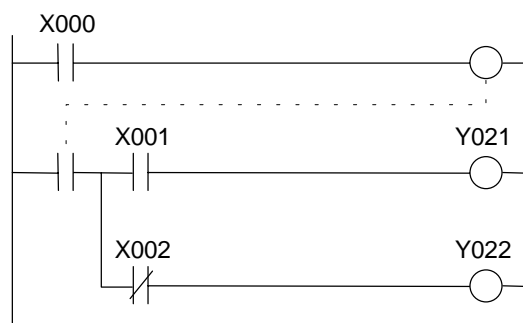

Note

- MCS and MCR must be used as a pair.
- Nesting is not allowed.

7. Instructions

JCS	Jump control set / reset
JCR	

Expression

Input - [JCS]
 ┆── [JCR]

Function

When the JCS input is ON, instructions between JCS and JCR are skipped (not executed). When the JCS input is OFF, ordinary operation is performed.

Execution condition

JCS input	Operation	Output
OFF	Ordinary operation	-
ON	Skips until JCR	-

Operand

No operand is required.

Example

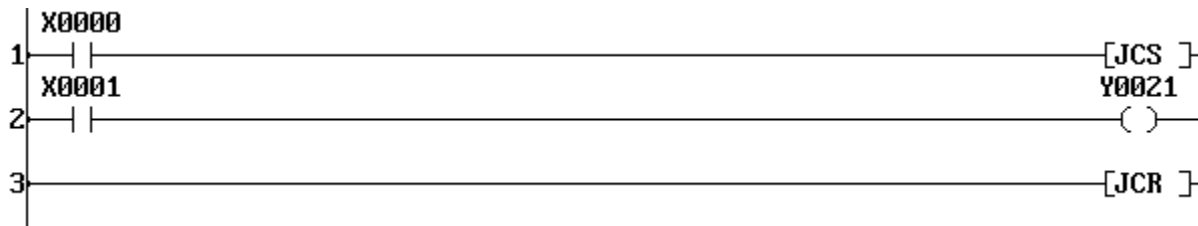

When X000 is ON, the rung 2 circuit is skipped, therefore Y021 is not changed its state regardless of the X001 state. When X000 is OFF, Y021 is controlled by the X001 state.

Note

- JCS and JCR must be used as a pair.
- Nesting is not allowed.

7. Instructions

END	End
-----	-----

Expression

H END H

Function

Indicates the end of main program or sub-program. Instructions after the END instruction are not executed. At least one END instruction is necessary in a program.

Execution condition

Input	Operation	Output
–	–	–
–	–	–

Operand

No operand is required.

Example

135		[END]	
-----	--	---------	--

Note

- For debugging purpose, 2 or more END instructions can be written in a program.
- Instructions after END instruction are not executed. Those steps are, however, counted as used steps.

7. Instructions

FUN 018	MOV	Data transfer
---------	-----	---------------

Expression

Input \neg [A MOV B]– Output

Function

When the input is ON, the data of A is stored in B.

Execution condition

Input	Operation	Output
OFF	No execution	OFF
ON	Execution	ON

Operand

	Name	Device						Register									Constant	Index			
		X	Y	R	S	T.	C.	XW	YW	RW	SW	T	C	D	I	J			K		
A	Source							√	√	√	√	√	√	√	√	√	√	√	√	√	√
B	Destination								√	√	√	√	√	√	√	√	√	√	√	√	√

Example 1 (constant to register)

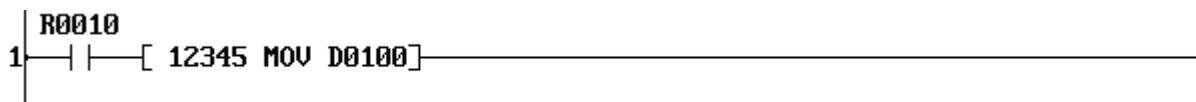

When R010 is ON, a constant data (12345) is stored in D0100 and the output is turned ON.

Example 2 (register to register)

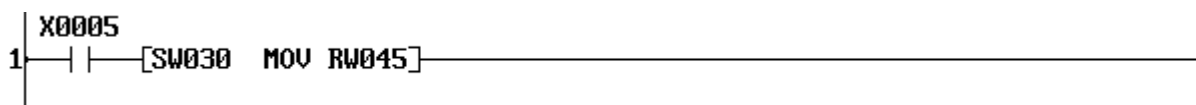

When X005 is ON, the data of SW30 is stored in RW45 and the output is turned ON. If SW30 is 500, the data 500 is stored in RW45.

Example 3 (index modification)

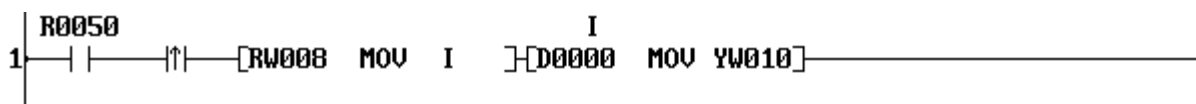

When R050 is changed from OFF to ON, the data of RW08 is stored in the index register I and the data of D(0000+I) is stored in YW10. If RW08 is 300, the data of D0300 is stored in YW10.

7. Instructions

FUN 019	DMOV	Double-word data transfer
---------	------	---------------------------

Expression

Input $\text{--[} A+1 \cdot A \text{ MOV } B+1 \cdot B \text{]--}$ Output

Function

When the input is ON, the double-word (32-bit) data of $A+1 \cdot A$ is stored in double-word register $B+1 \cdot B$. The data range is -2147483648 to 2147483647.

Execution condition

Input	Operation	Output
OFF	No execution	OFF
ON	Execution	ON

Operand

	Name	Device						Register										Constant	Index	
		X	Y	R	S	T	C	XW	YW	RW	SW	T	C	D	I	J	K			
A	Source							√	√	√	√	√	√	√	√	√	√	√	√	√
B	Destination								√	√	√	√	√	√	√	√	√	√		√

Example

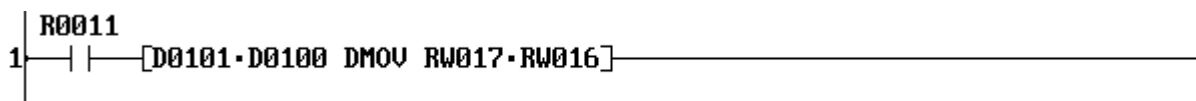

When R011 is ON, a double-word data of D0101·D0100 is stored in RW17·RW16 and the output is turned ON. If D0101·D0100 is 1234567, the data 1234567 is stored in RW17·RW16.

7. Instructions

FUN 020	NOT	Invert transfer
---------	-----	-----------------

Expression

Input $\neg[A \text{ NOT } B]$ – Output

Function

When the input is ON, the bit-inverted data of *A* is stored in *B*.

Execution condition

Input	Operation	Output
OFF	No execution	OFF
ON	Execution	ON

Operand

	Name	Device						Register								Constant	Index								
		X	Y	R	S	T	C	XW	YW	RW	SW	T	C	D	I			J	K						
<i>A</i>	Source							√	√	√	√	√	√	√	√	√	√	√	√	√	√	√	√	√	√
<i>B</i>	Destination								√	√	√	√	√	√	√	√	√	√	√	√					√

Example

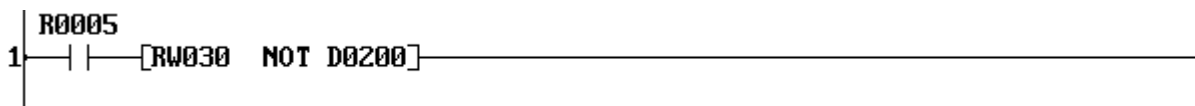

When R010 is ON, the bit-inverted data of RW30 is stored in D0200 and the output is turned ON. If RW30 is H4321, the bit-inverted data (HBCDE) is stored in D0200.

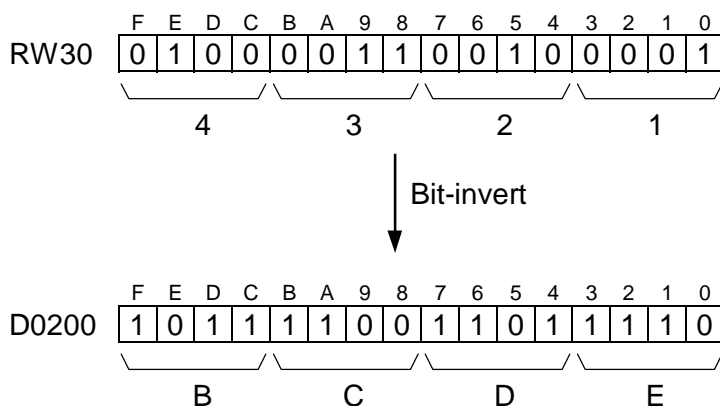

7. Instructions

FUN 022	XCHG	Data exchange
---------	------	---------------

Expression

Input \neg [A XCHG B] \neg Output

Function

When the input is ON, the data of A and the data of B is exchanged.

Execution condition

Input	Operation	Output
OFF	No execution	OFF
ON	Execution	ON

Operand

	Name	Device						Register								Constant	Index		
		X	Y	R	S	T.	C.	XW	YW	RW	SW	T	C	D	I			J	K
A	Operation data								√	√	√	√	√	√	√	√	√		√
B	Operation data								√	√	√	√	√	√	√	√	√		√

Example

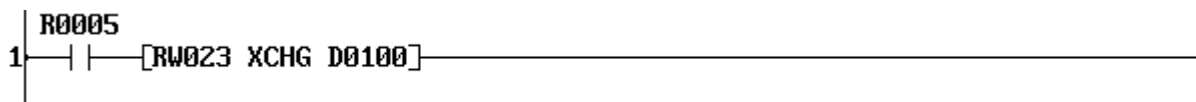

When R005 is ON, the data of RW23 and D0100 is exchanged. If the original data of RW23 is 23456 and that of D0100 is 291, the operation result is as follows.

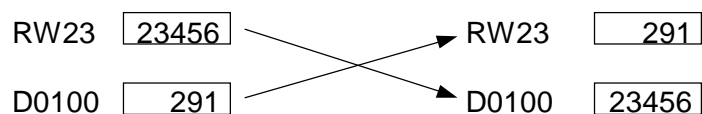

Before operation

After operation

7. Instructions

FUN 024	TINZ	Table initialize
---------	------	------------------

Expression

Input $\text{--[} A \text{ TINZ } (n) \text{ B]--}$ Output

Function

When the input is ON, the data of A is stored in n registers starting with B .

The allowable range of the table size n is 1 to 1024 words.

Execution condition

Input	Operation	Output
OFF	No execution	OFF
ON	Execution	ON

Operand

	Name	Device						Register										Constant	Index		
		X	Y	R	S	T	C	XW	YW	RW	SW	T	C	D	I	J	K				
A	Source							√	√	√	√	√	√	√	√	√	√	√	√	√	
n	Table size																			1 - 1024	
B	Start of destination								√	√	√	√	√	√							

Example

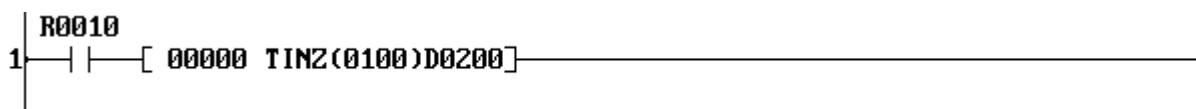

When R010 is ON, a constant data (0) is stored in 100 registers starting with D0200 (D0200 to D0299) and the output is turned ON.

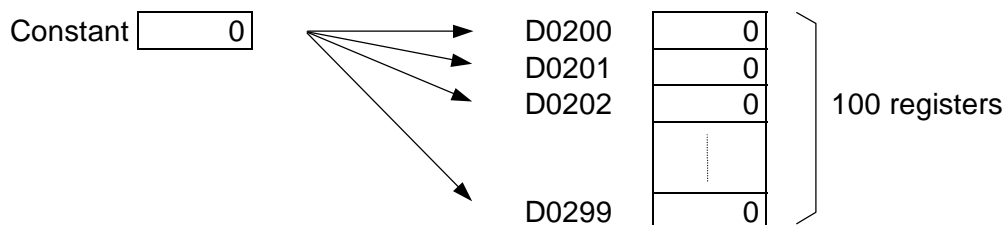

7. Instructions

FUN 025	TMOV	Table transfer
---------	------	----------------

Expression

Input \neg [A TMOV (n) B]– Output

Function

When the input is ON, the data of n registers starting with A are transferred to n registers starting with B in a block. The allowable range of the table size n is 1 to 1024 words.

Execution condition

Input	Operation	Output
OFF	No execution	OFF
ON	Execution	ON

Operand

	Name	Device						Register										Constant	Index		
		X	Y	R	S	T	C	XW	YW	RW	SW	T	C	D	I	J	K				
A	Start of source							√	√	√	√	√	√	√							
n	Table size																			1 - 1024	
B	Start of destination								√	√	√	√	√	√							

Example

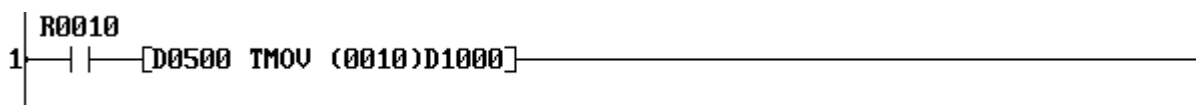

When $R010$ is ON, the data of $D0500$ to $D0509$ (10 registers) are block transferred to $D1000$ to $D1009$, and the output is turned ON.

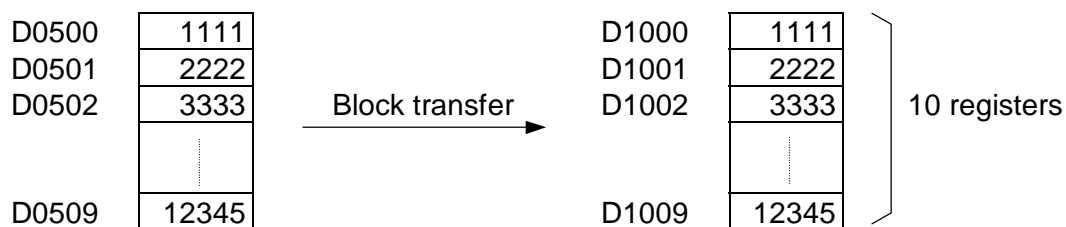

Note

- The source and destination tables can be overlapped.

7. Instructions

FUN 026	TNOT	Table invert transfer
---------	------	-----------------------

Expression

Input $\neg [A \text{ TNOT } (n) B]$ – Output

Function

When the input is ON, the data of n registers starting with A are bit-inverted and transferred to n registers starting with B in a block. The allowable range of the table size n is 1 to 1024 words.

Execution condition

Input	Operation	Output
OFF	No execution	OFF
ON	Execution	ON

Operand

	Name	Device						Register										Constant	Index			
		X	Y	R	S	T	C	XW	YW	RW	SW	T	C	D	I	J	K					
A	Start of source							√	√	√	√	√	√	√								
n	Table size																				1 - 1024	
B	Start of destination								√	√	√	√	√	√								

Example

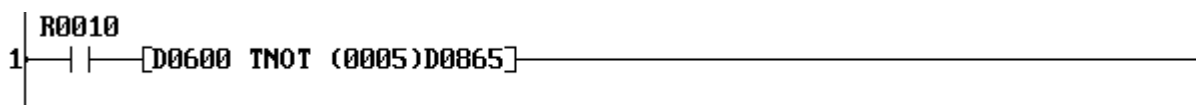

When R010 is ON, the data of D0600 to D0604 (5 registers) are bit-inverted and transferred to D0865 to D0869, and the output is turned ON.

D0600	H00FF	Bit-invert and transfer →	D0865	HFF00	5 registers
D0601	H0000		D0866	HFFFF	
D0602	H1234		D0867	HEDCB	
D0603	H5555		D0868	HAAAA	
D0604	H89AB		D0869	H7654	

Note

- The source and destination tables can be overlapped.

7. Instructions

FUN 027	+	Addition
---------	---	----------

Expression

Input $-(A + B \rightarrow C)-$ Output

Function

When the input is ON, the data of *A* and the data of *B* are added, and the result is stored in *C*. If the result is greater than 32767, the upper limit value 32767 is stored in *C*, and the output is turned ON. If the result is smaller than -32768, the lower limit value -32768 is stored in *C*, and the output is turned ON.

Execution condition

Input	Operation	Output
OFF	No execution	OFF
ON	Execution (normal)	OFF
	Execution (overflow or underflow occurred)	ON

Operand

	Name	Device						Register										Constant	Index		
		X	Y	R	S	T	C	XW	YW	RW	SW	T	C	D	I	J	K				
A	Augend							√	√	√	√	√	√	√	√	√	√	√	√	√	√
B	Addend							√	√	√	√	√	√	√	√	√	√	√	√	√	√
C	Sum								√	√	√	√	√	√	√	√	√	√	√		√

Example

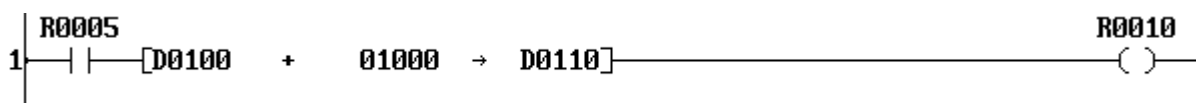

When R005 is ON, the data of D0100 and the constant data 1000 is added, and the result is stored in D0110.

If the data of D0100 is 12345, the result 13345 is stored in D0110, and R010 is turned OFF.

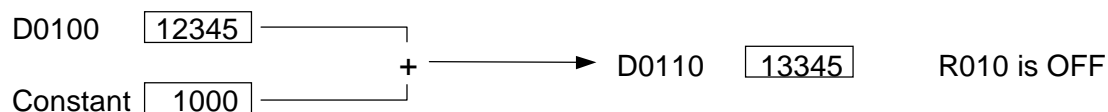

If the data of D0100 is 32700, the result exceeds the limit value, therefore 32767 is stored in D0110, and R010 is turned ON.

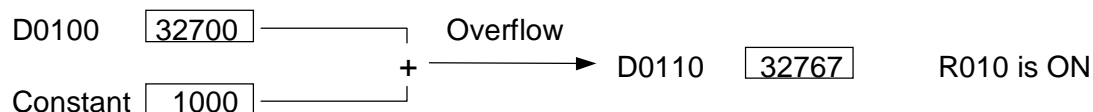

7. Instructions

FUN 028	-	Subtraction
---------	---	-------------

Expression

Input $\neg[A - B \rightarrow C]$ - Output

Function

When the input is ON, the data of B is subtracted from the data of A , and the result is stored in C . If the result is greater than 32767, the upper limit value 32767 is stored in C , and the output is turned ON. If the result is smaller than -32768, the lower limit value -32768 is stored in C , and the output is turned ON.

Execution condition

Input	Operation	Output
OFF	No execution	OFF
ON	Execution (normal)	OFF
	Execution (overflow or underflow occurred)	ON

Operand

	Name	Device						Register								Constant	Index		
		X	Y	R	S	T	C	XW	YW	RW	SW	T	C	D	I			J	K
A	Minuend							√	√	√	√	√	√	√	√	√	√	√	√
B	Subtrahend							√	√	√	√	√	√	√	√	√	√	√	√
C	Difference								√	√	√	√	√	√	√	√		√	

Example

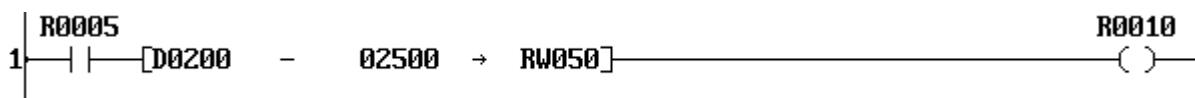

When R005 is ON, the constant data 2500 is subtracted from the data of D0200, and the result is stored in RW50.

If the data of D0200 is 15000, the result 12500 is stored in RW50, and R010 is turned OFF.

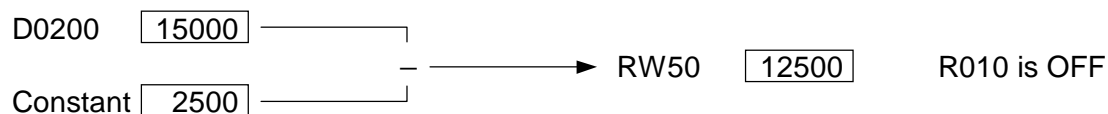

If the data of D0200 is -31000, the result is smaller than the limit value, therefore -32768 is stored in RW50, and R010 is turned ON.

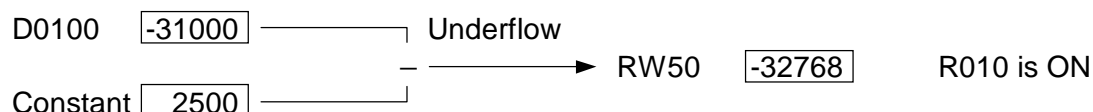

7. Instructions

FUN 029	*	Multiplication
---------	---	----------------

Expression

Input $\neg[A * B \rightarrow C+1 \cdot C]$ Output

Function

When the input is ON, the data of *A* is multiplied by the data of *B*, and the result is stored in double-length register *C+1*·*C*.

Execution condition

Input	Operation	Output
OFF	No execution	OFF
ON	Execution	ON

Operand

	Name	Device						Register										Constant	Index		
		X	Y	R	S	T	C	XW	YW	RW	SW	T	C	D	I	J	K				
<i>A</i>	Multiplicand							√	√	√	√	√	√	√	√	√	√	√	√	√	√
<i>B</i>	Multiplier							√	√	√	√	√	√	√	√	√	√	√	√	√	√
<i>C</i>	Product								√	√	√	√	√	√	√	√	√	√	√		√

Example

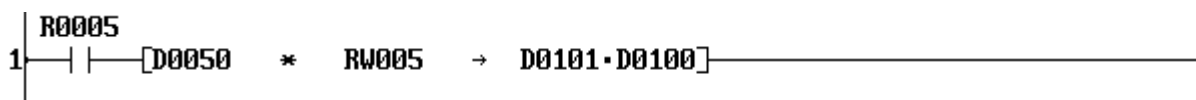

When R005 is ON, the data of D0050 is multiplied by the data of RW005, and the result is stored in double-length register D0101·D0100 (upper 16-bit in D0101 and lower 16-bit in D0100).

If the data of D0050 is 1500 and the data of RW005 is 20, the result 30000 is stored in D0101·D0100.

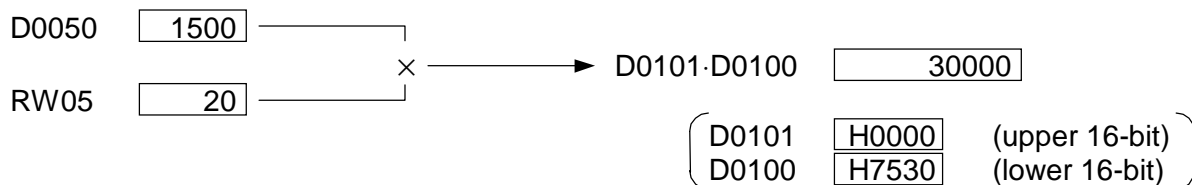

7. Instructions

FUN 030	/	Division
---------	---	----------

Expression

Input $-[A / B \rightarrow C]-$ Output

Function

When the input is ON, the data of A is divided by the data of B , and the quotient is stored in C and the remainder in $C+1$.

Execution condition

Input	Operation	Output	ERF
OFF	No execution	OFF	–
ON	Normal execution ($B \neq 0$)	ON	–
	No execution ($B = 0$)	OFF	Set

Operand

	Name	Device						Register								Constant	Index		
		X	Y	R	S	T	C	XW	YW	RW	SW	T	C	D	I			J	K
A	Dividend							√	√	√	√	√	√	√	√	√	√	√	√
B	Divisor							√	√	√	√	√	√	√	√	√	√	√	√
C	Quotient								√	√	√	√	√	√	√	√		√	

Example

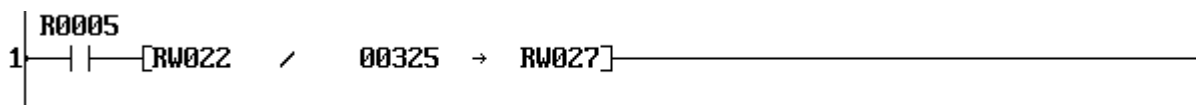

When R005 is ON, the data of RW22 is divided by the constant data 325, and the quotient is stored in RW27 and the remainder is stored in RW28.

If the data of RW22 is 2894, the quotient 8 is stored in RW27 and the remainder 294 is stored in RW28.

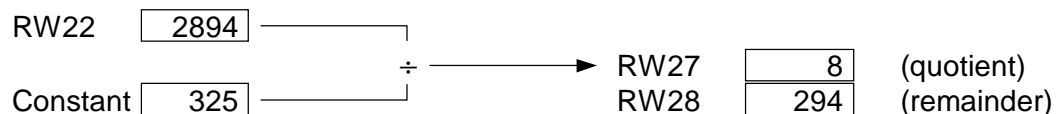

Note

- If divisor (operand B) is 0, ERF (instruction error flag = S051) is set to ON. The ERF (S051) can be reset to OFF by user program, e.g. $-[RST S051]-$.
- If the index register K is used as operand C , the remainder is ignored.
- If operand A is -32768 and operand B is -1 , the data -32768 is stored in C and 0 is stored in $C+1$.

7. Instructions

FUN 031	D+	Double-word addition
---------	----	----------------------

Expression

Input $-(A+1 \cdot A \text{ D+ } B+1 \cdot B \rightarrow C+1 \cdot C)-$ Output

Function

When the input is ON, the double-word data of $A+1 \cdot A$ and $B+1 \cdot B$ are added, and the result is stored in $C+1 \cdot C$. The data range is -2147483648 to 2147483647.

If the result is greater than 2147483647, the upper limit value 2147483647 is stored in $C+1 \cdot C$, and the output is turned ON. If the result is smaller than -2147483648, the lower limit value -2147483648 is stored in $C+1 \cdot C$, and the output is turned ON.

Execution condition

Input	Operation	Output
OFF	No execution	OFF
ON	Execution (normal)	OFF
	Execution (overflow or underflow occurred)	ON

Operand

	Name	Device						Register								Constant	Index		
		X	Y	R	S	T	C	XW	YW	RW	SW	T	C	D	I			J	K
A	Augend							√	√	√	√	√	√	√				√	
B	Addend							√	√	√	√	√	√	√				√	
C	Sum								√	√	√	√	√	√					

Example



When R005 is ON, the data of D0011·D0010 and the constant data 100000 is added, and the result is stored in D0101·D0100.

If the data of D0011·D0010 is 300000, the result 400000 is stored in D0101·D0100, and R010 is turned OFF. (No overflow/underflow)

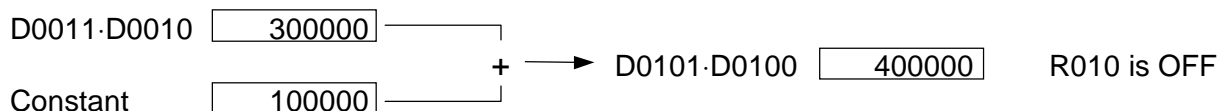

7. Instructions

FUN 032	D-	Double-word subtraction
---------	----	-------------------------

Expression

Input $-(A+1 \cdot A \text{ D- } B+1 \cdot B \rightarrow C+1 \cdot C)$ – Output

Function

When the input is ON, the double-word data of $B+1 \cdot B$ is subtracted from $A+1 \cdot A$, and the result is stored in $C+1 \cdot C$. The data range is -2147483648 to 2147483647.

If the result is greater than 2147483647, the upper limit value 2147483647 is stored in $C+1 \cdot C$, and the output is turned ON. If the result is smaller than -2147483648, the lower limit value -2147483648 is stored in $C+1 \cdot C$, and the output is turned ON.

Execution condition

Input	Operation	Output
OFF	No execution	OFF
ON	Execution (normal)	OFF
	Execution (overflow or underflow occurred)	ON

Operand

	Name	Device						Register								Constant	Index		
		X	Y	R	S	T	C	XW	YW	RW	SW	T	C	D	I			J	K
A	Minuend							√	√	√	√	√	√	√				√	
B	Subtrahend							√	√	√	√	√	√	√				√	
C	Difference								√	√	√	√	√	√					

Example



When R005 is ON, the double-word data of RW25·RW24 is subtracted from the double-word data of D0101·D0100, and the result is stored in D0103·D0102.

If the data of D0101·D0100 is 1580000 and the data of RW25·RW24 is 80000, the result 1500000 is stored in D0103·D0102, and R010 is turned OFF. (No overflow/underflow)

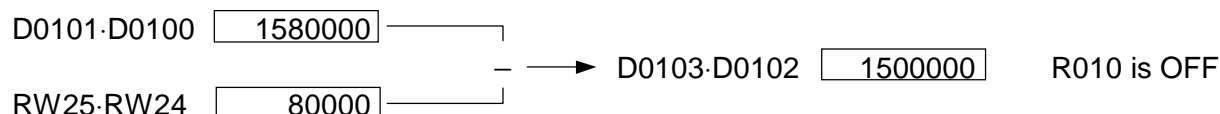

7. Instructions

FUN 035	+C	Addition with carry
---------	----	---------------------

Expression

Input $-(A +C B \rightarrow C)-$ Output

Function

When the input is ON, the data of A , B and the carry flag (CF = S050) are added, and the result is stored in C . If carry is occurred in the operation, the carry flag is set to ON. If the result is greater than 32767 or smaller than -32768, the output is turned ON.

This instruction is used to perform unsigned addition or double-length addition.

Execution condition

Input	Operation				Output	CF
OFF	No execution				OFF	–
ON	Execution	Normal	No carry		OFF	Reset
			Carry occurred		OFF	Set
		Overflow / underflow	No carry		ON	Reset
			Carry occurred		ON	Set

Operand

	Name	Device						Register								Constant	Index		
		X	Y	R	S	T	C	XW	YW	RW	SW	T	C	D	I			J	K
A	Augend							√	√	√	√	√	√	√	√	√	√	√	√
B	Addend							√	√	√	√	√	√	√	√	√	√	√	√
C	Sum								√	√	√	√	√	√	√	√		√	

Example

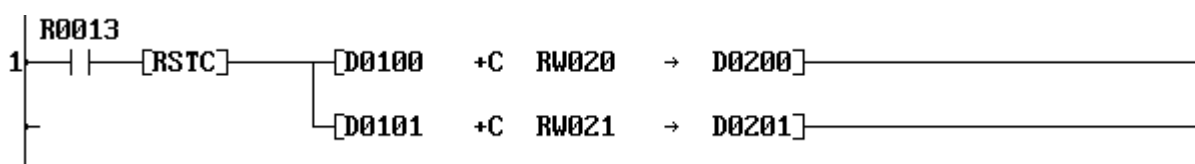

When R013 is ON, the data of double-length registers D0101·D0100 and RW21·RW20 are added, and the result is stored in D0201·D0200. The RSTC is a instruction to reset the carry flag before starting the calculation.

If the data of D0101·D0100 is 12345678 and RW21·RW20 is 54322, the result 12400000 is stored in D0201·D0200.

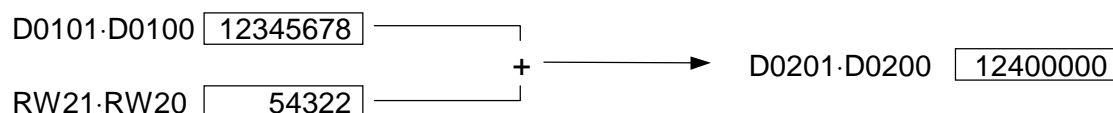

7. Instructions

FUN 036	-C	Subtraction with carry
---------	----	------------------------

Expression

Input $-[A -C B \rightarrow C]$ - Output

Function

When the input is ON, the data of B and the carry flag (CF = S050) are subtracted from A , and the result is stored in C . If borrow is occurred in the operation, the carry flag is set to ON. If the result is greater than 32767 or smaller than -32768, the output is turned ON.

This instruction is used to perform unsigned subtraction or double-length subtraction.

Execution condition

Input	Operation				Output	CF
OFF	No execution				OFF	-
ON	Execution	Normal	No borrow		OFF	Reset
			Borrow occurred		OFF	Set
		Overflow / underflow	No borrow		ON	Reset
			Borrow occurred		ON	Set

Operand

	Name	Device						Register								Constant	Index		
		X	Y	R	S	T	C	XW	YW	RW	SW	T	C	D	I			J	K
A	Minuend							√	√	√	√	√	√	√	√	√	√	√	√
B	Subtrahend							√	√	√	√	√	√	√	√	√	√	√	√
C	Difference								√	√	√	√	√	√	√	√		√	

Example

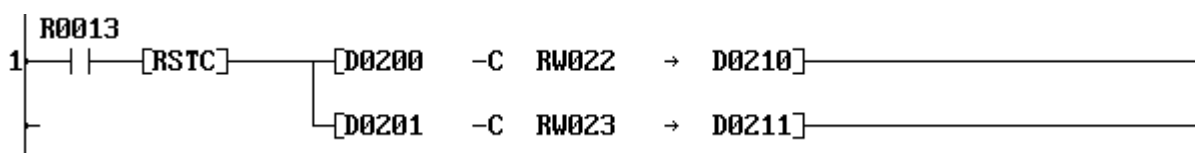

When R013 is ON, the data of double-length register RW23·RW22 is subtracted from the data of D0201·D0200, and the result is stored in D0211·D0210. The RSTC is a instruction to reset the carry flag before starting the calculation.

If the data of D0201·D0200 is 12345678 and RW23·RW22 is 12340000, the result 5678 is stored in D0211·D0210.

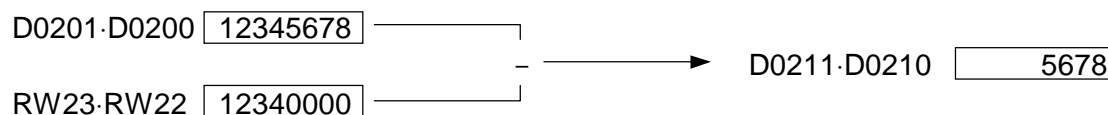

7. Instructions

FUN 039	U*	Unsigned multiplication
---------	----	-------------------------

Expression

Input $\neg[A \text{ U* } B \rightarrow C+1 \cdot C]$ – Output

Function

When the input is ON, the unsigned data of *A* and *B* are multiplied, and the result is stored in double-length register *C+1*·*C*. The data range of *A* and *B* is 0 to 65535 (unsigned 16-bit data)

Execution condition

Input	Operation	Output
OFF	No execution	OFF
ON	Execution	ON

Operand

	Name	Device						Register										Constant	Index		
		X	Y	R	S	T	C	XW	YW	RW	SW	T	C	D	I	J	K				
A	Multiplicand							√	√	√	√	√	√	√	√	√	√	√	√	√	√
B	Multiplier							√	√	√	√	√	√	√	√	√	√	√	√	√	√
C	Product								√	√	√	√	√	√	√	√	√	√	√		√

Example

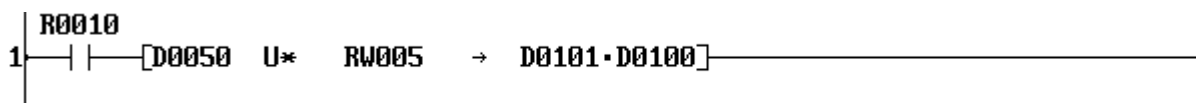

When R010 is ON, the data of D0050 is multiplied by the data of RW05, and the result is stored in double-length register D0101·D0100 (upper 16-bit in D0101 and lower 16-bit in D0100).

If the data of D0050 is 52500 and the data of RW05 is 30, the result 1575000 is stored in D0101·D0100.

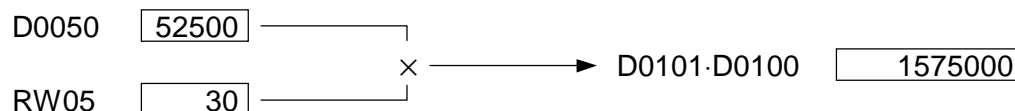

Note

- This instruction handles the register data as unsigned integer.

7. Instructions

FUN 040	U/	Unsigned division
---------	----	-------------------

Expression

Input $-\lceil A \text{ U/ } B \rightarrow C \rceil$ – Output

Function

When the input is ON, the unsigned data of A is divided by the unsigned data of B , and the quotient is stored in C and the remainder in $C+1$.

The data range of A and B is 0 to 65535 (unsigned 16-bit data)

Execution condition

Input	Operation	Output	ERF
OFF	No execution	OFF	–
ON	Normal execution ($B \neq 0$)	ON	–
	No execution ($B = 0$)	OFF	Set

Operand

	Name	Device						Register								Constant	Index			
		X	Y	R	S	T	C	XW	YW	RW	SW	T	C	D	I			J	K	
A	Dividend							√	√	√	√	√	√	√	√	√	√	√	√	√
B	Divisor							√	√	√	√	√	√	√	√	√	√	√	√	√
C	Quotient								√	√	√	√	√	√	√	√	√	√	√	√

Example

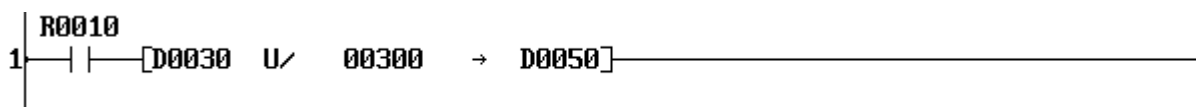

When R010 is ON, the data of D0030 is divided by the constant data 300, and the quotient is stored in D0050 and the remainder is stored in D0051.

If the data of D0030 is 54321, the quotient 181 is stored in D0050 and the remainder 21 is stored in D0051.

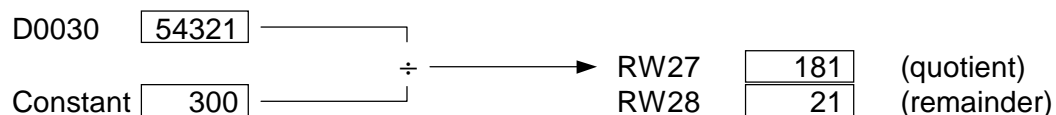

Note

- If divisor (operand B) is 0, ERF (instruction error flag = S051) is set to ON. The ERF (S051) can be reset to OFF by user program, e.g. $-\lceil \text{RST } S051 \rceil$ –.
- If the index register K is used as operand C , the remainder is ignored.
- This instruction handles the register data as unsigned integer.

7. Instructions

FUN 041	DIV	Unsigned double/single division
---------	-----	---------------------------------

Expression

Input $\neg[A+1 \cdot A \text{ DIV } B \rightarrow C]$ – Output

Function

When the input is ON, the double-word data of $A+1 \cdot A$ is divided by the data of B , and the quotient is stored in C and the remainder in $C+1$. The data range of $A+1 \cdot A$ is 0 to 4294967295, and the data range of B and C is 0 to 65535.

If the quotient is greater than 65535 (overflow), the limit value 65535 is stored in C , 0 is stored in $C+1$, and the instruction error flag (ERF = S051) is set to ON.

Execution condition

Input	Operation	Output	ERF
OFF	No execution	OFF	–
ON	Normal execution ($B \neq 0$)	ON	–
	Overflow ($B \neq 0$)	ON	Set
	No execution ($B = 0$)	OFF	Set

Operand

	Name	Device						Register									Constant	Index	
		X	Y	R	S	T	C	XW	YW	RW	SW	T	C	D	I	J			K
A	Dividend							√	√	√	√	√	√	√				√	
B	Divisor							√	√	√	√	√	√	√				√	
C	Quotient								√	√	√	√	√	√					

Example

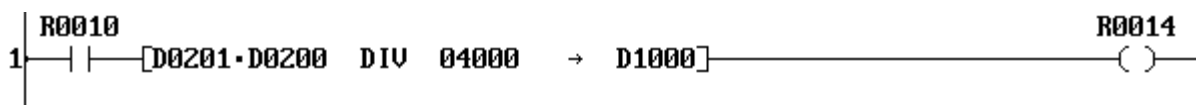

When R010 is ON, the double-word data of D0201·D0200 is divided by the constant data 4000, and the quotient is stored in D1000 and the remainder is stored in D1001.

If the data of D0201·D0200 is 332257, the quotient 83 is stored in D1000 and the remainder 257 is stored in D1001.

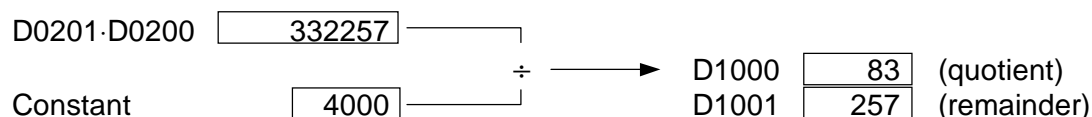

Note

- If divisor (operand B) is 0, ERF (instruction error flag = S051) is set to ON. The ERF (S051) can be reset to OFF by user program, e.g. $\neg[\text{RST S051}]$ –.
- This instruction handles the register data as unsigned integer.

7. Instructions

FUN 043	+1	Increment
---------	----	-----------

Expression

Input $-\text{[+1 A]}$ – Output

Function

When the input is ON, the data of *A* is increased by 1 and stored in *A*.

Execution condition

Input	Operation	Output
OFF	No execution	OFF
ON	Execution	ON

Operand

	Name	Device						Register								Constant	Index		
		X	Y	R	S	T.	C.	XW	YW	RW	SW	T	C	D	I			J	K
A	Operation data								√	√	√	√	√	√	√	√	√		√

Example

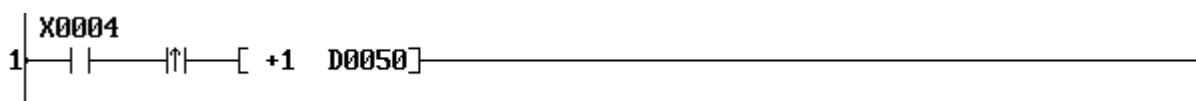

At the rising edge of X004 changes from OFF to ON, the data of D0050 is increased by 1 and stored in D0050.

If the data of D0050 is 750 before the execution, it will be 751 after the execution.



Note

- There is no limit value for this instruction. When the data of operand *A* is 32767 before the execution, it will be -32768 after the execution.

7. Instructions

FUN 045	-1	Decrement
---------	----	-----------

Expression

Input $-\lbrack -1 A \rbrack$ - Output

Function

When the input is ON, the data of A is decreased by 1 and stored in A .

Execution condition

Input	Operation	Output
OFF	No execution	OFF
ON	Execution	ON

Operand

	Name	Device						Register										Constant	Index			
		X	Y	R	S	T	C	XW	YW	RW	SW	T	C	D	I	J	K					
A	Operation data								√	√	√	√	√	√	√	√	√	√	√	√		√

Example

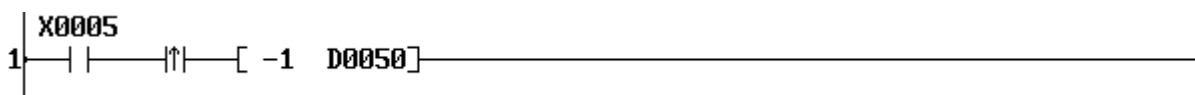

At the rising edge of $X005$ changes from OFF to ON, the data of $D0050$ is decreased by 1 and stored in $D0050$.

If the data of $D0050$ is 1022 before the execution, it will be 1021 after the execution.



Note

- There is no limit value for this instruction. When the data of operand A is -32768 before the execution, it will be 32767 after the execution.

7. Instructions

FUN 048	AND	AND
---------	-----	-----

Expression

Input $\neg [A \text{ AND } B \rightarrow C]$ Output

Function

When the input is ON, this instruction finds logical AND of *A* and *B*, and stores the result in *C*.

Execution condition

Input	Operation	Output
OFF	No execution	OFF
ON	Execution	ON

Operand

	Name	Device						Register									Constant	Index		
		X	Y	R	S	T	C	XW	YW	RW	SW	T	C	D	I	J			K	
<i>A</i>	Source							√	√	√	√	√	√	√	√	√	√	√	√	√
<i>B</i>	Source							√	√	√	√	√	√	√	√	√	√	√	√	√
<i>C</i>	AND								√	√	√	√	√	√	√	√	√		√	

Example

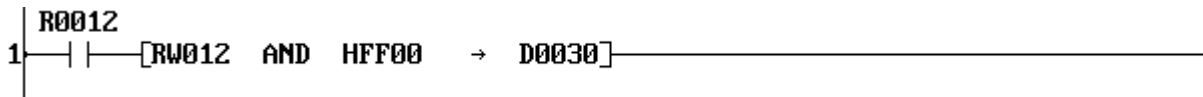

When R012 is ON, logical AND operation is executed for the data of RW12 and the constant data HFF00, and the result is stored in D0030.

If the data of RW12 is H3456, the result H3400 is stored in D0030.

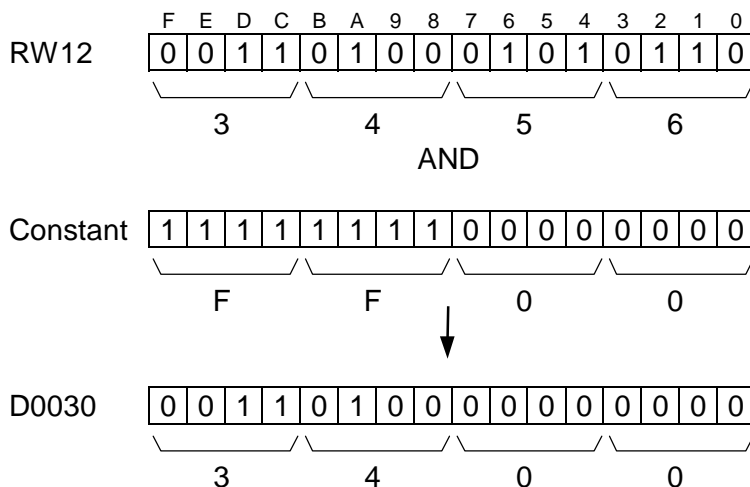

7. Instructions

FUN 050	OR	OR
---------	----	----

Expression

Input $\neg[A \text{ OR } B \rightarrow C]$ Output

Function

When the input is ON, this instruction finds logical OR of *A* and *B*, and stores the result in *C*.

Execution condition

Input	Operation	Output
OFF	No execution	OFF
ON	Execution	ON

Operand

	Name	Device						Register									Constant	Index		
		X	Y	R	S	T	C	XW	YW	RW	SW	T	C	D	I	J			K	
<i>A</i>	Source							√	√	√	√	√	√	√	√	√	√	√	√	√
<i>B</i>	source							√	√	√	√	√	√	√	√	√	√	√	√	√
<i>C</i>	OR								√	√	√	√	√	√	√	√	√		√	

Example

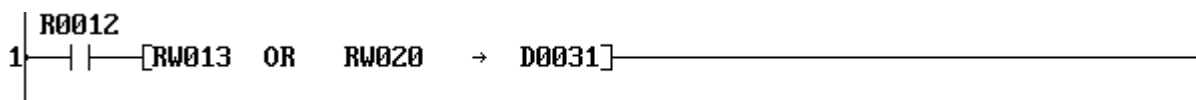

When R012 is ON, logical OR operation is executed for the data of RW13 and RW20, and the result is stored in D0031.

If the data of RW13 is H5678 and RW20 is H4321, the result H5779 is stored in D0031.

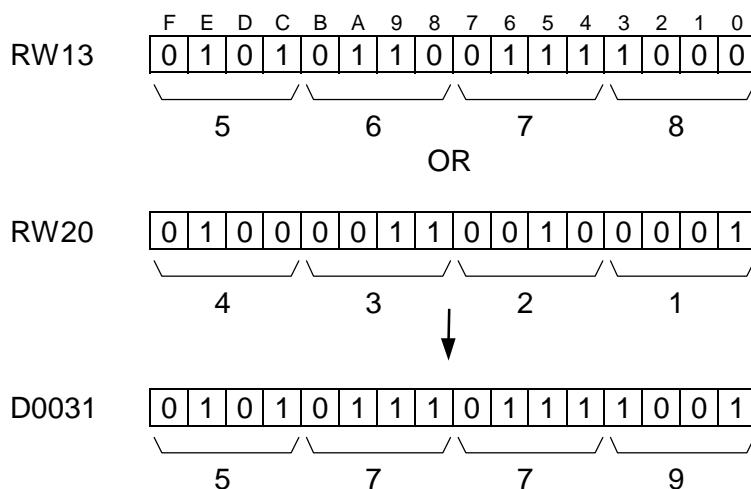

7. Instructions

FUN 052	EOR	Exclusive OR
---------	-----	--------------

Expression

Input \rightarrow [A EOR B \rightarrow C] \rightarrow Output

Function

When the input is ON, this instruction finds exclusive OR of A and B , and stores the result in C .

Execution condition

Input	Operation	Output
OFF	No execution	OFF
ON	Execution	ON

Operand

	Name	Device						Register									Constant	Index	
		X	Y	R	S	T	C	XW	YW	RW	SW	T	C	D	I	J			K
A	Source							√	√	√	√	√	√	√	√	√	√	√	√
B	source							√	√	√	√	√	√	√	√	√	√	√	√
C	Exclusive OR								√	√	√	√	√	√	√	√		√	

Example

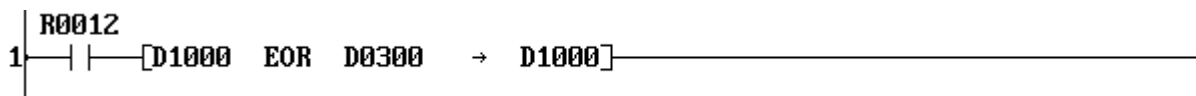

When $R012$ is ON, exclusive OR operation is executed for the data of $D1000$ and $D0300$, and the result is stored in $D1000$.

If the data of $D1000$ is $H5678$ and $D0300$ is $H4321$, the result $H1559$ is stored in $D1000$.

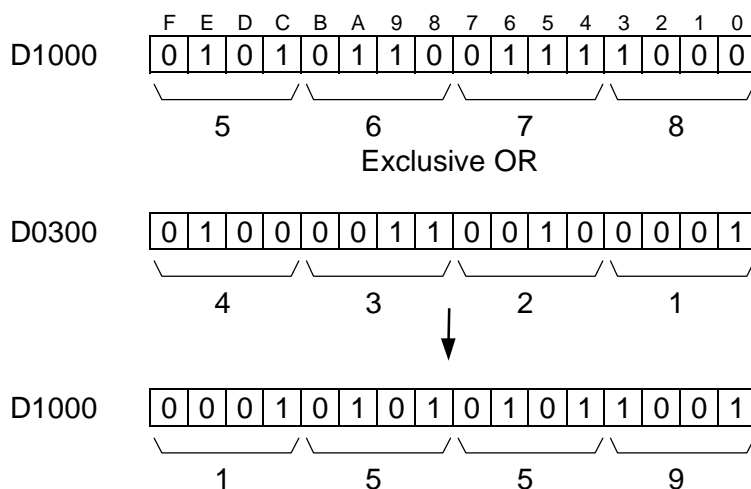

7. Instructions

FUN 056	MAVE	Moving average
---------	------	----------------

Expression

Input $\text{--[A MAVE (}n\text{) B } \rightarrow \text{ C]--}$ Output

Function

When the input is ON, this instruction calculates the average value of the latest n scan's register A data, and stores it in C . The allowable range of n is 1 to 64.

This instruction is useful for filtering the analog input signal.

The latest n scan's data of A are stored in n registers starting with B , and $C+1$ are used as pointer.

Execution condition

Input	Operation	Output
OFF	No execution	OFF
ON	Execution	ON

Operand

	Name	Device						Register								Constant	Index		
		X	Y	R	S	T	C	XW	YW	RW	SW	T	C	D	I			J	K
A	Input data							√	√	√	√	√	√	√	√	√	√	√	
n	Data size																	1 - 64	
B	Start of table								√	√	√	√	√	√					
C	Output data								√	√	√	√	√	√	√	√	√		

Example

1 [XW004 MAVE (05) D0900 → D0010]

The latest 5 scan's data of XW04 is stored in D0900 to D0904 (5 registers), and the average value of them is calculated and stored in D0010.

D0011 is used as internal work data.

	XW04	D0010	
1st scan	1000	200	= (1000) / 5
2nd scan	1005	401	= (1000 + 1005) / 5
3rd scan	1009	603	= (1000 + 1005 + 1009) / 5
4th scan	1012	805	= (1000 + 1005 + 1009 + 1012) / 5
5th scan	1007	1006	= (1000 + 1005 + 1009 + 1012 + 1007) / 5
6th scan	1004	1007	= (1005 + 1009 + 1012 + 1007 + 1004) / 5
7th scan	998	1006	= (1009 + 1012 + 1007 + 1004 + 998) / 5
8th scan	994	1003	= (1012 + 1007 + 1004 + 998 + 994) / 5

7. Instructions

FUN 062	HTOA	Hex to ASCII conversion
---------	------	-------------------------

Expression

Input $-[A \text{ HTOA}(n) B]-$ Output

Function

When the input is ON, the hexadecimal data of n registers starting with A is converted into ASCII characters and stored in B and after. The uppermost digit of source A is stored in lower byte of destination B , and followed in this order. The allowable range of n is 1 to 32.

Execution condition

Input	Operation	Output
OFF	No execution	OFF
ON	Execution	ON

Operand

	Name	Device						Register								Constant	Index		
		X	Y	R	S	T	C.	XW	YW	RW	SW	T	C	D	I			J	K
A	Source							√	√	√	√	√	√	√	√	√	√	√	
n	Data size																	1 - 32	
B	Destination								√	√	√	√	√	√					

Example



When R010 is ON, 4 words data of D0100 to D0103 are converted into ASCII characters, and stored in 8 words registers starting with D0200.

	<table border="1" style="width: 100%; border-collapse: collapse;"> <thead> <tr> <th style="width: 50%; text-align: left;">F</th> <th style="width: 50%; text-align: right;">0</th> </tr> </thead> <tbody> <tr><td>D0100</td><td>H0123</td></tr> <tr><td>D0101</td><td>H4567</td></tr> <tr><td>D0102</td><td>H89AB</td></tr> <tr><td>D0103</td><td>HCDEF</td></tr> </tbody> </table>	F	0	D0100	H0123	D0101	H4567	D0102	H89AB	D0103	HCDEF	Converted →	<table border="1" style="width: 100%; border-collapse: collapse;"> <thead> <tr> <th style="width: 50%; text-align: left;">F</th> <th style="width: 50%; text-align: right;">8</th> <th style="width: 50%; text-align: left;">7</th> <th style="width: 50%; text-align: right;">0</th> </tr> </thead> <tbody> <tr><td>D0220</td><td>"1" (H31)</td><td>"0" (H30)</td><td></td></tr> <tr><td>D0221</td><td>"3" (H33)</td><td>"2" (H32)</td><td></td></tr> <tr><td>D0222</td><td>"5" (H35)</td><td>"4" (H34)</td><td></td></tr> <tr><td>D0223</td><td>"7" (H37)</td><td>"6" (H36)</td><td></td></tr> <tr><td>D0224</td><td>"9" (H39)</td><td>"8" (H38)</td><td></td></tr> <tr><td>D0225</td><td>"B" (H42)</td><td>"A" (H41)</td><td></td></tr> <tr><td>D0226</td><td>"D" (H44)</td><td>"C" (H43)</td><td></td></tr> <tr><td>D0227</td><td>"F" (H46)</td><td>"E" (H45)</td><td></td></tr> </tbody> </table>	F	8	7	0	D0220	"1" (H31)	"0" (H30)		D0221	"3" (H33)	"2" (H32)		D0222	"5" (H35)	"4" (H34)		D0223	"7" (H37)	"6" (H36)		D0224	"9" (H39)	"8" (H38)		D0225	"B" (H42)	"A" (H41)		D0226	"D" (H44)	"C" (H43)		D0227	"F" (H46)	"E" (H45)	
F	0																																																
D0100	H0123																																																
D0101	H4567																																																
D0102	H89AB																																																
D0103	HCDEF																																																
F	8	7	0																																														
D0220	"1" (H31)	"0" (H30)																																															
D0221	"3" (H33)	"2" (H32)																																															
D0222	"5" (H35)	"4" (H34)																																															
D0223	"7" (H37)	"6" (H36)																																															
D0224	"9" (H39)	"8" (H38)																																															
D0225	"B" (H42)	"A" (H41)																																															
D0226	"D" (H44)	"C" (H43)																																															
D0227	"F" (H46)	"E" (H45)																																															

Note

- If index register (I, J or K) is used for the operand A , only $n = 1$ is allowed. Otherwise, boundary error will occur.

7. Instructions

FUN 064	TEST	Bit test
---------	------	----------

Expression

Input $\neg[A \text{ TEST } B]$ – Output

Function

When the input is ON, this instruction finds logical AND of *A* and *B*. Then if the result is not 0, sets the output to ON.

Execution condition

Input	Operation	Output
OFF	No execution	OFF
ON	Execution	When the result is not 0
		When the result is 0
		ON
		OFF

Operand

	Name	Device						Register										Constant	Index			
		X	Y	R	S	T	C	XW	YW	RW	SW	T	C	D	I	J	K					
<i>A</i>	Source							√	√	√	√	√	√	√	√	√	√	√	√	√	√	√
<i>B</i>	Test data							√	√	√	√	√	√	√	√	√	√	√	√	√	√	√

Example

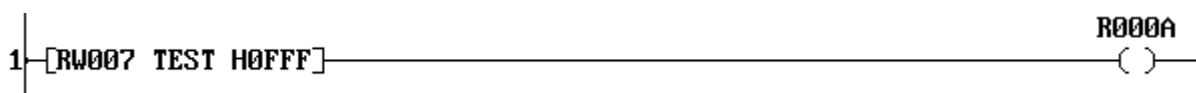

Logical AND operation is executed for the data of RW07 and the constant data H0FFF, and if the result is not 0, R00A is turned ON. (R00A is turned ON when any device from R070 to R07B is ON.)

If the data of RW07 is H4008, R00A is turned ON.

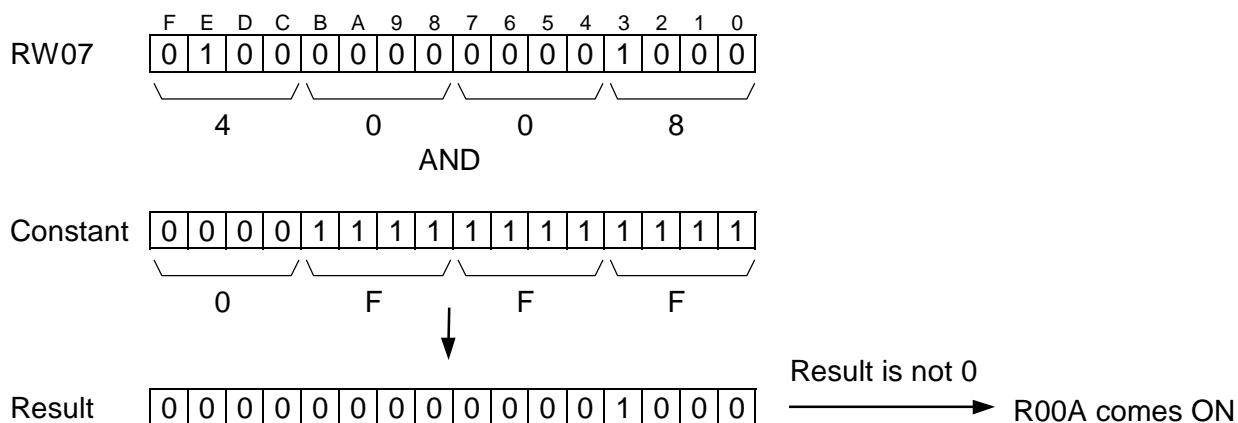

7. Instructions

FUN 068	SHR1	1 bit shift right
---------	------	-------------------

Expression

Input \neg [SHR1 A]– Output

Function

When the input is ON, the data of register A is shifted 1 bit to the right (LSB direction). 0 is stored in the left most bit (MSB). The pushed out bit state is stored in the carry flag (CF = S050). After the operation, if the right most bit (LSB) is ON, the output is turned ON.

Execution condition

Input	Operation		Output	CF
OFF	No execution		OFF	–
ON	Execution	When LSB = 1	ON	Set or reset
		When LSB = 0	OFF	Set or reset

Operand

	Name	Device						Register								Constant	Index				
		X	Y	R	S	T	C	XW	YW	RW	SW	T	C	D	I			J	K		
A	Operation data								√	√	√	√	√	√	√	√	√	√	√		√

Example



When X007 is changed from OFF to ON, the data of RW15 is shifted 1 bit to the right.

The figure below shows an operation example.

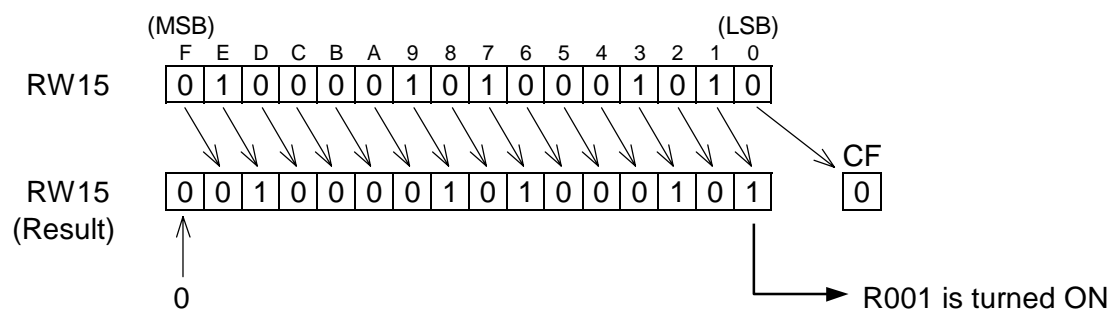

7. Instructions

FUN 069	SHL1	1 bit shift left
---------	------	------------------

Expression

Input $-\text{[SHL1 A]}$ – Output

Function

When the input is ON, the data of register A is shifted 1 bit to the left (MSB direction). 0 is stored in the right most bit (LSB). The pushed out bit state is stored in the carry flag (CF = S050). After the operation, if the left most bit (MSB) is ON, the output is turned ON.

Execution condition

Input	Operation	Output	CF
OFF	No execution	OFF	–
ON	Execution	When MSB = 1	ON Set or reset
		When MSB = 0	OFF Set or reset

Operand

	Name	Device						Register								Constant	Index			
		X	Y	R	S	T	C	XW	YW	RW	SW	T	C	D	I			J	K	
A	Operation data								√	√	√	√	√	√	√	√	√	√		√

Example

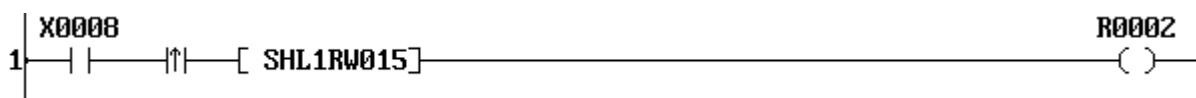

When X008 is changed from OFF to ON, the data of RW15 is shifted 1 bit to the left.

The figure below shows an operation example.

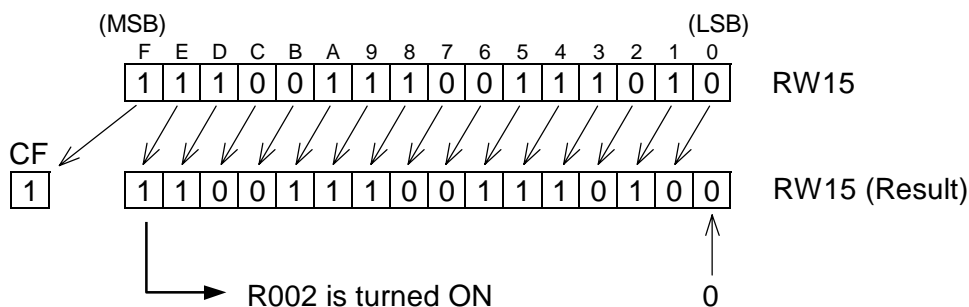

7. Instructions

FUN 070	SHR	n bit shift right
---------	-----	-------------------

Expression

Input $\rightarrow [A \text{ SHR } n \rightarrow B]$ Output

Function

When the input is ON, the data of register *A* is shifted *n* bits to the right (LSB direction) including the carry flag (CF = S050), and stored in *B*. 0 is stored in upper *n* bits. After the operation, if the right most bit (LSB) is ON, the output is turned ON.

Execution condition

Input	Operation		Output	CF
OFF	No execution		OFF	–
ON	Execution	When LSB = 1	ON	Set or reset
		When LSB = 0	OFF	Set or reset

Operand

	Name	Device						Register										Constant	Index							
		X	Y	R	S	T	C	XW	YW	RW	SW	T	C	D	I	J	K									
<i>A</i>	Source							√	√	√	√	√	√	√	√	√	√	√	√	√	√	√	√	√	√	√
<i>n</i>	Shift bits																								1 - 16	
<i>B</i>	Destination								√	√	√	√	√	√	√	√	√	√	√	√	√	√	√	√	√	√

Example



When X007 is changed from OFF to ON, the data of RW18 is shifted 5 bits to the right and the result is stored in RW20.

The figure below shows an operation example.

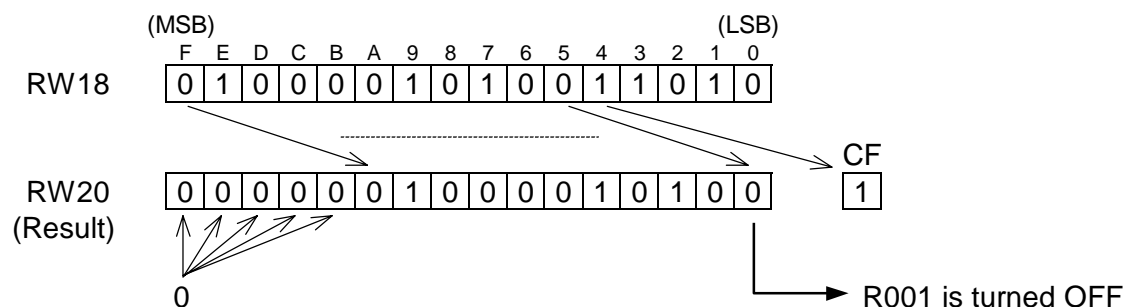

7. Instructions

FUN 071	SHL	n bit shift left
---------	-----	------------------

Expression

Input $\neg [A \text{ SHL } n \rightarrow B]$ – Output

Function

When the input is ON, the data of register *A* is shifted *n* bits to the left (MSB direction) including the carry flag (CF = S050), and stored in *B*. 0 is stored in lower *n* bits. After the operation, if the left most bit (MSB) is ON, the output is turned ON.

Execution condition

Input	Operation	Output	CF
OFF	No execution	OFF	–
ON	Execution	When MSB = 1	ON Set or reset
		When MSB = 0	OFF Set or reset

Operand

	Name	Device						Register										Constant	Index		
		X	Y	R	S	T	C	XW	YW	RW	SW	T	C	D	I	J	K				
<i>A</i>	Source							√	√	√	√	√	√	√	√	√	√	√	√	√	√
<i>n</i>	Shift bits																			1 - 16	
<i>B</i>	Destination								√	√	√	√	√	√	√	√	√	√	√		√

Example



When X008 is changed from OFF to ON, the data of RW18 is shifted 3 bits to the left and the result is stored in RW20.

The figure below shows an operation example.

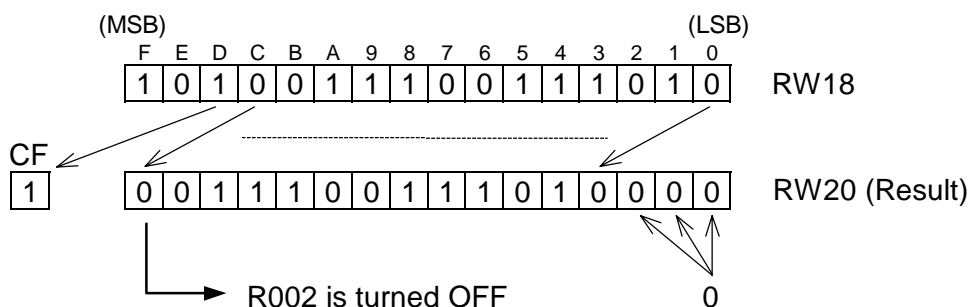

7. Instructions

FUN 074	SR	Shift register
---------	----	----------------

Expression

Data input	$\left[\begin{array}{c} D \text{ SR} \text{ } Q \\ S \text{ } (n) \\ E \text{ } \text{ } A \end{array} \right]$	Output
Shift input		
Enable input		

Function

While the enable input is ON, this instruction shifts the data of the bit table, size n starting with A , 1 bit to the left (upper address direction) when the shift input is ON. The state of the data input is stored in A . The pushed out bit state is stored in the carry flag (CF = S050).

When the enable input is OFF, all bits in the table and the carry flag are reset to OFF.

Execution condition

Enable input	Operation	Output	CF
OFF	Resets all bits in the bit table	OFF	Reset
ON	When the shift input is ON	Shift execution	Last bit Set or reset
	When the shift input is OFF	No execution	state

Operand

	Name	Device						Register							Constant	Index		
		X	Y	R	S	T	C	XW	YW	RW	SW	T	C	D			I	J
A	Leading device		√	√	√													
n	Device size																	1 - 64

Example



32 devices starting with R100 (R100 to R11F) is specified as a shift register.

When R010 is OFF, the data of the shift register is reset to 0. (R100 to R11F are reset to OFF)
The carry flag (CF = S050) is also reset to OFF.

While R010 is ON, the data of the shift register is shifted 1 bit to the upper address direction when X009 is changed from OFF to ON. At the same time, the state of X008 is stored in the leading bit (R100).

The output (R011) indicates the state of the last bit (R11F).

7. Instructions

The figure below shows an operation example. (When X009 is changed from OFF to ON)

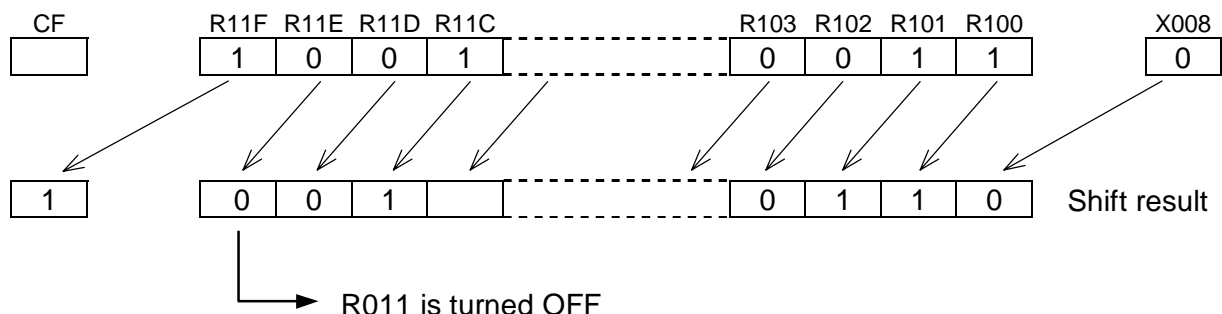

Note

- When the shift input is ON, the shift operation is performed every scan. Use a transitional contact for the shift input to detect the state changing.
- For the data input and the shift input, direct linking to a connecting point is not allowed. In this case, insert a dummy contact (always ON special device = S04F, etc.) just before the input.

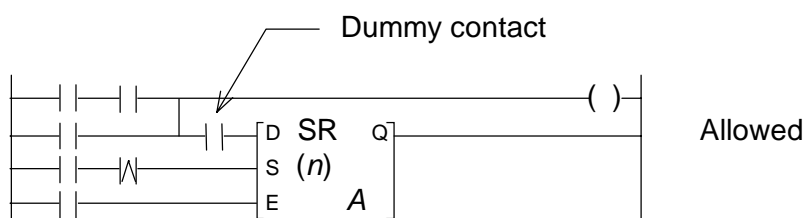
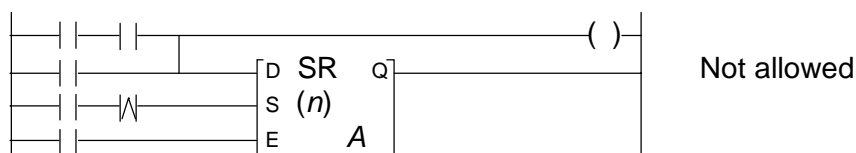

7. Instructions

FUN 075	DSR	Bi-directional shift register
---------	-----	-------------------------------

Expression

Data input	$\left[\begin{array}{c} \text{D DSR } Q \\ \text{S } (n) \\ \text{E} \\ \text{L } \quad A \end{array} \right]$	Output
Shift input		
Enable input		
Direction input		

Function

While the enable input (E) is ON, this instruction shifts the data of the bit table, size n starting with A , 1 bit when the shift input (S) is ON. The shift direction is determined by the state of the direction input (L).

When L is OFF, the direction is right (lower address direction).

When L is ON, the direction is left (upper address direction).

The state of the data input (D) is stored in the highest bit if right shift, and stored in the lowest bit A if left shift. The pushed out bit state is stored in the carry flag (CF = S050).

When the enable input (E) is OFF, all bits in the table and the carry flag are reset to OFF.

Execution condition

Enable input	Operation		Output	CF	
OFF	Resets all bits in the bit table		OFF	Reset	
ON	S = ON	L = ON	Shift left execution	Highest bit state	Set or reset
		L = OFF	Shift right execution	Lowest bit state	Set or reset
	S = OFF	No execution	Highest bit state	–	

Operand

	Name	Device						Register									Constant	Index		
		X	Y	R	S	T	C	XW	YW	RW	SW	T	C	D	I	J			K	
A	Leading device		√	√	√															
n	Device size																		1 - 64	

Example

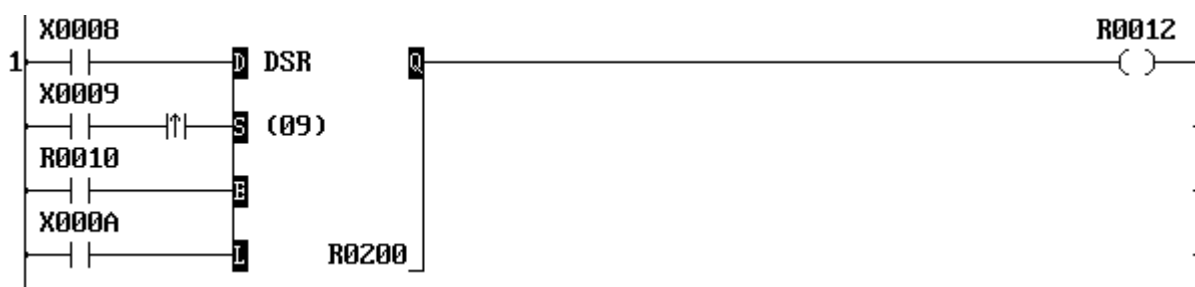

7. Instructions

9 devices starting with R200 (R200 to R208) is specified as a shift register.

When R010 is OFF, the data of the shift register is reset to 0. (R200 to R208 are reset to OFF)

The carry flag (CF = S050) is also reset to OFF.

While R010 is ON the following operation is enabled.

- When X00A is ON (shift left), the data of the shift register is shifted 1 bit to the upper address direction when X009 is changed from OFF to ON. At the same time, the state of X008 is stored in the leading bit (R200). The output (R012) indicates the state of the highest bit (R208).
- When X00A is OFF (shift right), the data of the shift register is shifted 1 bit to the lower address direction when X009 is changed from OFF to ON. At the same time, the state of X008 is stored in the highest bit (R208). The output (R012) indicates the state of the lowest bit (R200).

The figure below shows an operation example.

(When X00A is ON and X009 is changed from OFF to ON)

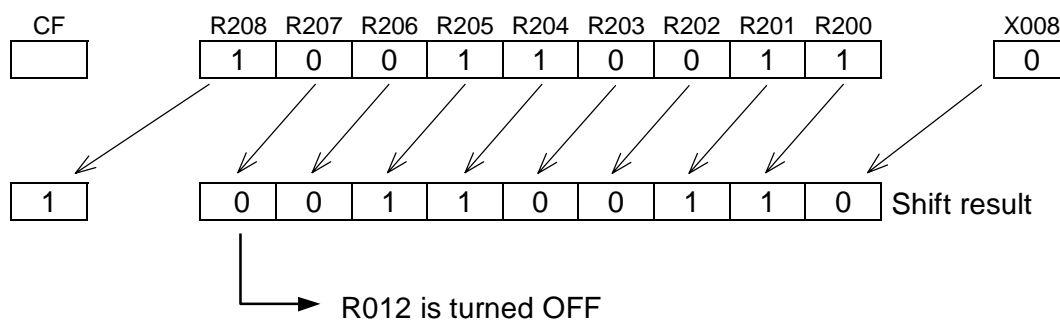

(When X00A is OFF and X009 is changed from OFF to ON)

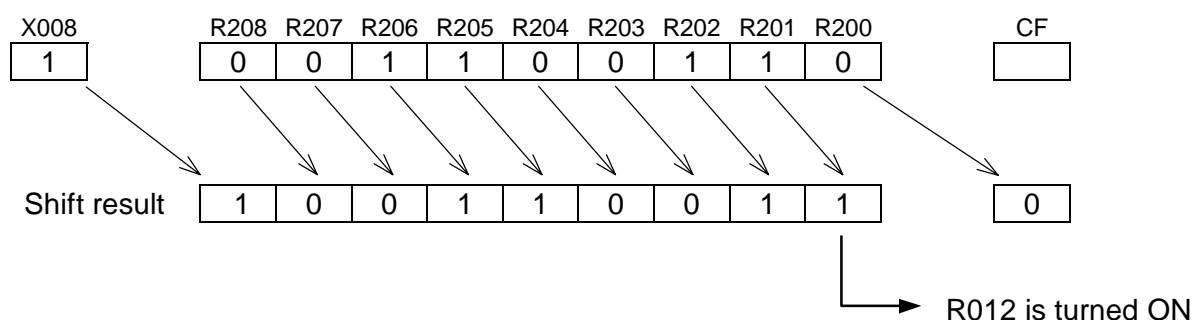

Note

- When the shift input is ON, the shift operation is performed every scan. Use a transitional contact for the shift input to detect the state changing.
- For the data input, the shift input and the enable input, direct linking to a connecting point is not allowed. In this case, insert a dummy contact (always ON special device = S04F, etc.) just before the input. Refer to Note of Shift register FUN 074.

7. Instructions

FUN 078	RTR1	1 bit rotate right
---------	------	--------------------

Expression

Input \neg [RTR1 A] \neg Output

Function

When the input is ON, the data of register A is rotated 1 bit to the right (LSB direction). The pushed out bit state is stored in the left most bit (MSB) and in the carry flag (CF = S050). After the operation, if the right most bit (LSB) is ON, the output is turned ON.

Execution condition

Input	Operation		Output	CF
OFF	No execution		OFF	–
ON	Execution	When LSB = 1	ON	Set or reset
		When LSB = 0	OFF	Set or reset

Operand

	Name	Device						Register								Constant	Index					
		X	Y	R	S	T	C	XW	YW	RW	SW	T	C	D	I			J	K			
A	Operation data								√	√	√	√	√	√	√	√	√	√	√	√		√

Example

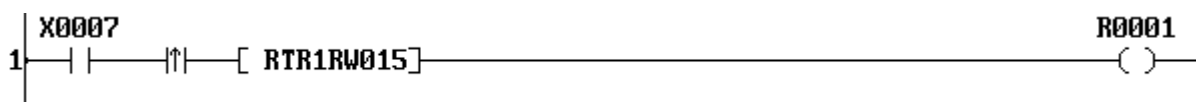

When X007 is changed from OFF to ON, the data of RW15 is rotated 1 bit to the right.

The figure below shows an operation example.

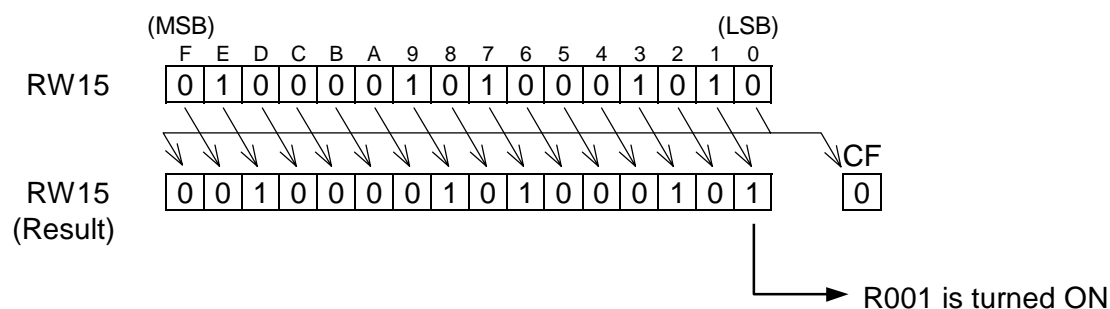

7. Instructions

FUN 079	RTL1	1 bit rotate left
---------	------	-------------------

Expression

Input \neg [RTL1 A]– Output

Function

When the input is ON, the data of register A is rotated 1 bit to the left (MSB direction). The pushed out bit state is stored in the right most bit (LSB) and in the carry flag (CF = S050). After the operation, if the left most bit (MSB) is ON, the output is turned ON.

Execution condition

Input	Operation	Output	CF
OFF	No execution	OFF	–
ON	Execution	When MSB = 1	ON Set or reset
		When MSB = 0	OFF Set or reset

Operand

	Name	Device						Register								Constant	Index		
		X	Y	R	S	T	C	XW	YW	RW	SW	T	C	D	I			J	K
A	Operation data								√	√	√	√	√	√	√	√	√		√

Example

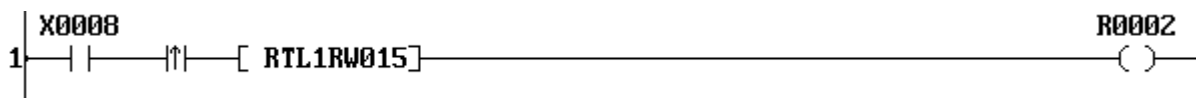

When X008 is changed from OFF to ON, the data of RW15 is rotated 1 bit to the left.

The figure below shows an operation example.

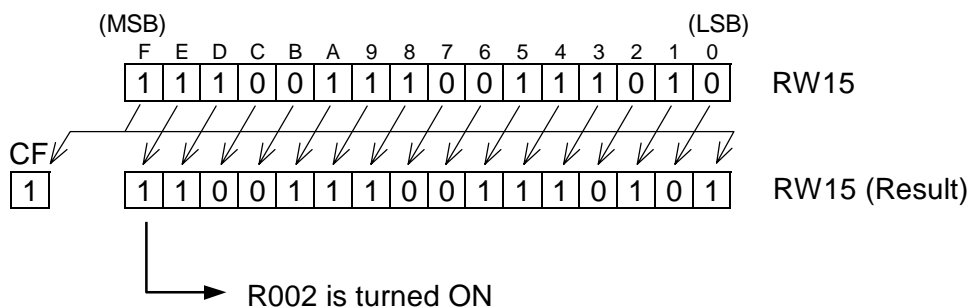

7. Instructions

FUN 080	RTR	n bit rotate right
---------	-----	--------------------

Expression

Input $\neg[A \text{ RTR } n \rightarrow B]$ – Output

Function

When the input is ON, the data of register *A* is rotated *n* bits to the right (LSB direction), and stored in *B*. After the operation, if the right most bit (LSB) is ON, the output is turned ON.

Execution condition

Input	Operation		Output	CF
OFF	No execution		OFF	–
ON	Execution	When LSB = 1	ON	Set or reset
		When LSB = 0	OFF	Set or reset

Operand

	Name	Device						Register										Constant	Index		
		X	Y	R	S	T	C	XW	YW	RW	SW	T	C	D	I	J	K				
<i>A</i>	Source							√	√	√	√	√	√	√	√	√	√	√	√	√	√
<i>n</i>	Shift bits																			1 - 16	
<i>B</i>	Destination								√	√	√	√	√	√	√	√	√	√	√		√

Example



When X007 is changed from OFF to ON, the data of RW18 is rotated 5 bits to the right and the result is stored in RW20.

The figure below shows an operation example.

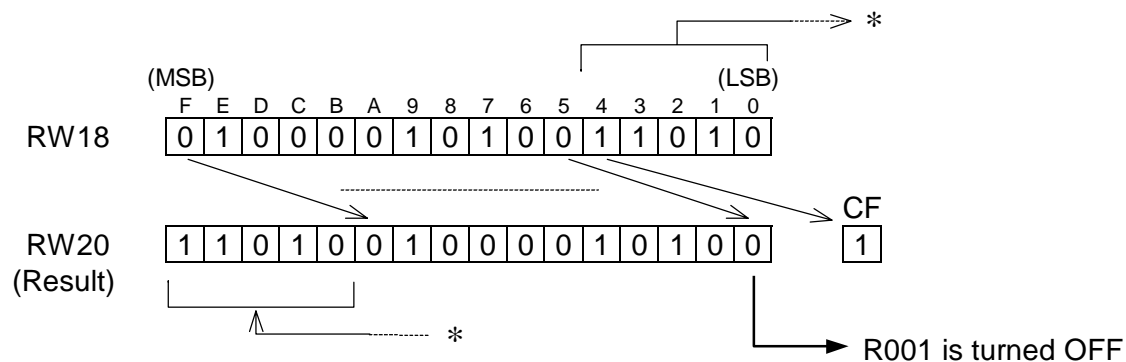

7. Instructions

FUN 081	RTL	n bit rotate left
---------	-----	-------------------

Expression

Input $\neg [A \text{ RTL } n \rightarrow B]$ – Output

Function

When the input is ON, the data of register *A* is rotated *n* bits to the left (MSB direction), and stored in *B*. After the operation, if the left most bit (MSB) is ON, the output is turned ON.

Execution condition

Input	Operation	Output	CF
OFF	No execution	OFF	–
ON	Execution	When MSB = 1	ON Set or reset
		When MSB = 0	OFF Set or reset

Operand

	Name	Device						Register										Constant	Index
		X	Y	R	S	T	C	XW	YW	RW	SW	T	C	D	I	J	K		
<i>A</i>	Source							√	√	√	√	√	√	√	√	√	√	√	√
<i>n</i>	Shift bits																	1 - 16	
<i>B</i>	Destination								√	√	√	√	√	√	√	√		√	

Example



When X008 is changed from OFF to ON, the data of RW18 is rotated 3 bits to the left and the result is stored in RW20.

The figure below shows an operation example.

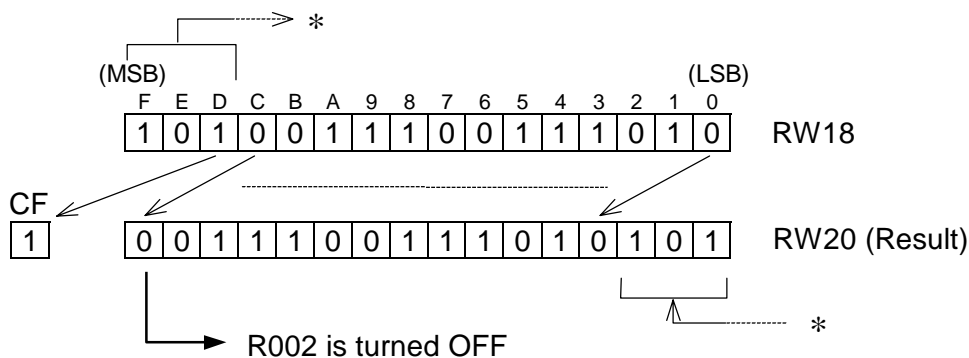

7. Instructions

FUN 090	MPX	Multiplexer
---------	-----	-------------

Expression

Input $-\lceil A \text{ MPX } (n) B \rightarrow C \rceil$ - Output

Function

When the input is ON, the data of the register which is designated by B in the table, size n starting with A , is transferred to C .

Execution condition

Input	Operation	Output
OFF	No execution	OFF
ON	Normal execution	OFF
	Pointer over (no execution)	ON

Operand

	Name	Device						Register										Constant	Index			
		X	Y	R	S	T	C	XW	YW	RW	SW	T	C	D	I	J	K					
A	Start of table							√	√	√	√	√	√	√								
n	Table size																				1 - 64	
B	Pointer							√	√	√	√	√	√	√	√	√	√	√	√	√	0 - 63	
C	Destination								√	√	√	√	√	√	√	√	√	√	√	√		

Example

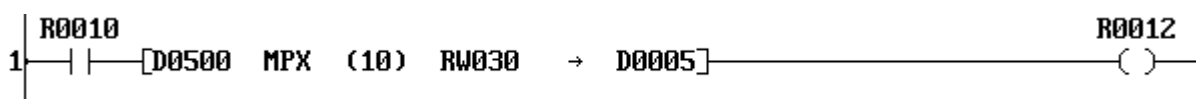

When R010 is ON, the register data which is designated by RW30 is read from the table D0500 to D0509 (10 registers size), and stored in D0005.

If the data of RW30 is 7, D0507 data is transferred to D0005.

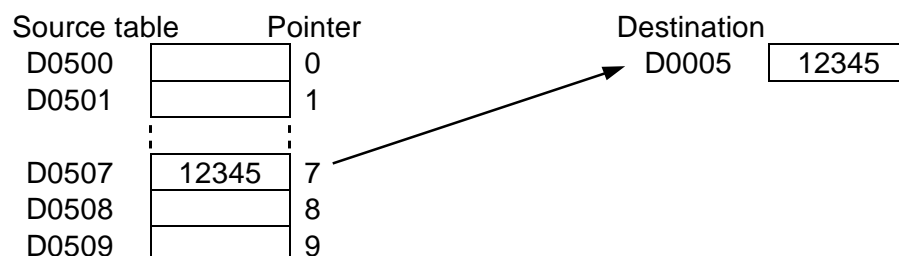

Note

- If the pointer data designates outside the table (10 or more in the above example), the transfer is not executed and the output comes ON.
- The table must be within the effective range of the register address.

7. Instructions

FUN 091	DPX	Demultiplexer
---------	-----	---------------

Expression

Input $\neg [A \text{ DPX } (n) B \rightarrow C]$ Output

Function

When the input is ON, the data of A is transferred to the register which is designated by B in the table, size n starting with C .

Execution condition

Input	Operation	Output
OFF	No execution	OFF
ON	Normal execution	OFF
	Pointer over (no execution)	ON

Operand

	Name	Device						Register										Constant	Index		
		X	Y	R	S	T	C.	XW	YW	RW	SW	T	C	D	I	J	K				
A	Source							√	√	√	√	√	√	√	√	√	√	√	√	√	
n	Table size																			1 - 64	
B	Pointer							√	√	√	√	√	√	√	√	√	√	√	√	0 - 63	
C	Start of table								√	√	√	√	√	√							

Example

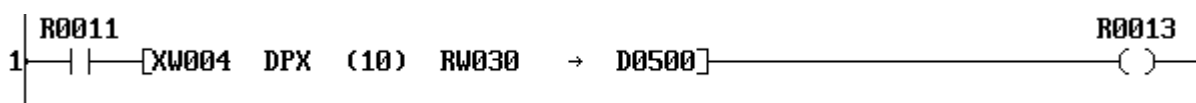

When R011 is ON, the data of XW04 is transferred to the register which is designated by RW30 in the table D0500 to D0509 (10 registers size).

If the data of RW30 is 8, XW04 data is transferred to D0508.

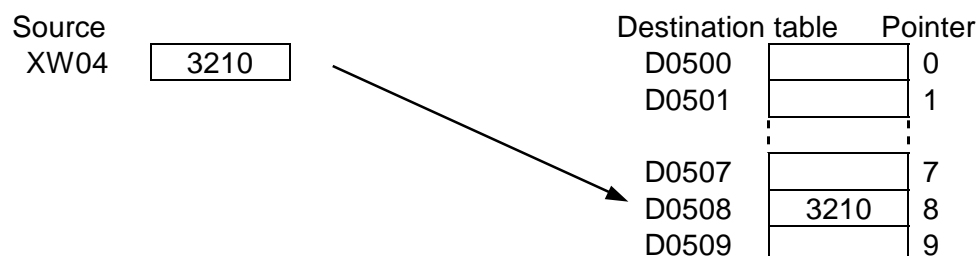

Note

- If the pointer data designates outside the table (10 or more in the above example), the transfer is not executed and the output comes ON.
- The table must be within the effective range of the register address.

7. Instructions

FUN 096	>	Greater than
---------	---	--------------

Expression

Input $\neg[A > B]$ – Output

Function

When the input is ON, the data of A and the data of B are compared, and if A is greater than B , the output is turned ON.

Execution condition

Input	Operation		Output
OFF	No execution		OFF
ON	Execution	$A > B$	ON
		$A \leq B$	OFF

Operand

	Name	Device						Register								Constant	Index		
		X	Y	R	S	T	C	XW	YW	RW	SW	T	C	D	I			J	K
A	Compared data							√	√	√	√	√	√	√	√	√	√	√	√
B	Reference data							√	√	√	√	√	√	√	√	√	√	√	√

Example

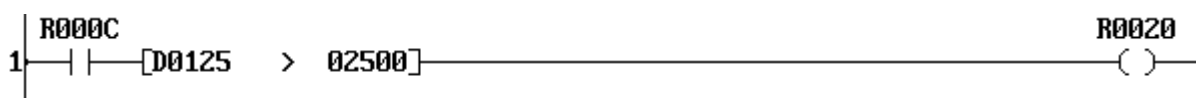

When R00C is ON, the data of D0125 is compared with the constant data 2500, and if the data of D0125 is greater than 2500, R020 is turned ON.

If the data of D0125 is 3000, the comparison result is true. Consequently, R020 is turned ON.

D0125 > Constant \longrightarrow R020 is ON

If the data of D0125 is -100, the comparison result is false. Consequently, R020 is turned OFF.

D0125 \leq Constant \longrightarrow R020 is OFF

Note

- This instruction deals with the data as signed integer (-32768 to 32767).

7. Instructions

FUN 097	>=	Greater than or equal
---------	----	-----------------------

Expression

Input $\neg[A \geq B]$ – Output

Function

When the input is ON, the data of *A* and the data of *B* are compared, and if *A* is greater than or equal to *B*, the output is turned ON.

Execution condition

Input	Operation	Output
OFF	No execution	OFF
ON	Execution	$A \geq B$
		$A < B$

Operand

	Name	Device						Register								Constant	Index		
		X	Y	R	S	T	C	XW	YW	RW	SW	T	C	D	I			J	K
A	Compared data							√	√	√	√	√	√	√	√	√	√	√	√
B	Reference data							√	√	√	√	√	√	√	√	√	√	√	√

Example

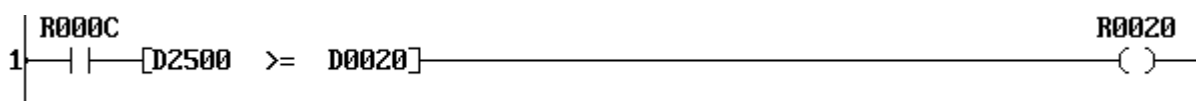

When R00C is ON, the data of D0125 is compared with the data of D0020, and if the data of D0125 is greater than or equal to the data of D0020, R020 is turned ON.

If the data of D0125 is 3000 and that of D0020 is 3000, the comparison result is true. Consequently, R020 is turned ON.

D0125 3000 \geq D0020 3000 \longrightarrow R020 is ON

If the data of D0125 is -1500 and that of D0020 is 0, the comparison result is false. Consequently, R020 is turned OFF.

D0125 -1500 $<$ D0020 0 \longrightarrow R020 is OFF

Note

- This instruction deals with the data as signed integer (-32768 to 32767).

7. Instructions

FUN 098	=	Equal
---------	---	-------

Expression

Input $\neg[A = B]$ – Output

Function

When the input is ON, the data of *A* and the data of *B* are compared, and if *A* is equal to *B*, the output is turned ON.

Execution condition

Input	Operation		Output
OFF	No execution		OFF
ON	Execution	$A = B$	ON
		$A \neq B$	OFF

Operand

	Name	Device						Register								Constant	Index		
		X	Y	R	S	T	C	XW	YW	RW	SW	T	C	D	I			J	K
A	Compared data							√	√	√	√	√	√	√	√	√	√	√	√
B	Reference data							√	√	√	√	√	√	√	√	√	√	√	√

Example

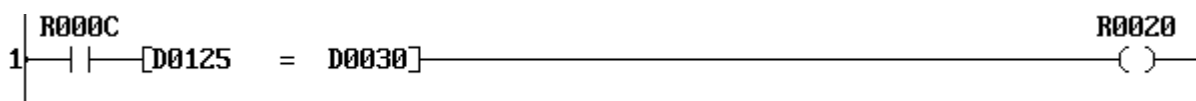

When R00C is ON, the data of D0125 is compared with the data of D0030, and if the data of D0125 is equal to the data of D0030, R020 is turned ON.

If the data of D0125 is 3000 and that of D0020 is 3000, the comparison result is true. Consequently, R020 is turned ON.

D0125 3000 = D0030 3000 \longrightarrow R020 is ON

If the data of D0125 is -1500 and that of D0020 is 0, the comparison result is false. Consequently, R020 is turned OFF.

D0125 -1500 \neq D0030 0 \longrightarrow R020 is OFF

Note

- This instruction deals with the data as signed integer (-32768 to 32767).

7. Instructions

FUN 099	◁▷	Not equal
---------	----	-----------

Expression

Input $\neg[A \triangleleft B]$ – Output

Function

When the input is ON, the data of *A* and the data of *B* are compared, and if *A* is not equal to *B*, the output is turned ON.

Execution condition

Input	Operation	Output
OFF	No execution	OFF
ON	Execution	$A \neq B$
		$A = B$
		ON
		OFF

Operand

	Name	Device						Register								Constant	Index		
		X	Y	R	S	T	C	XW	YW	RW	SW	T	C	D	I			J	K
A	Compared data							√	√	√	√	√	√	√	√	√	√	√	√
B	Reference data							√	√	√	√	√	√	√	√	√	√	√	√

Example

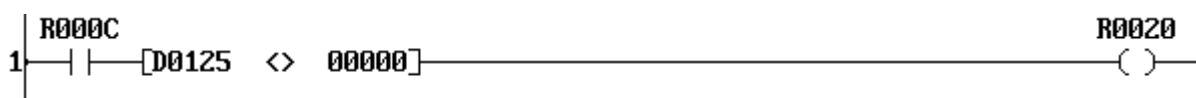

When R00C is ON, the data of D0125 is compared with the constant data 0, and if the data of D0125 is not 0, R020 is turned ON.

If the data of D0125 is 10, the comparison result is true. Consequently, R020 is turned ON.

D0125 10 \neq Constant 0 \longrightarrow R020 is ON

If the data of D0125 is 0, the comparison result is false. Consequently, R020 is turned OFF.

D0125 0 $=$ Constant 0 \longrightarrow R020 is OFF

Note

- This instruction deals with the data as signed integer (-32768 to 32767).

7. Instructions

FUN 100	<	Less than
---------	---	-----------

Expression

Input $\neg[A < B]$ – Output

Function

When the input is ON, the data of *A* and the data of *B* are compared, and if *A* is less than *B*, the output is turned ON.

Execution condition

Input	Operation		Output
OFF	No execution		OFF
ON	Execution	$A < B$	ON
		$A \geq B$	OFF

Operand

	Name	Device						Register										Constant	Index
		X	Y	R	S	T	C	XW	YW	RW	SW	T	C	D	I	J	K		
A	Compared data							√	√	√	√	√	√	√	√	√	√	√	√
B	Reference data							√	√	√	√	√	√	√	√	√	√	√	√

Example

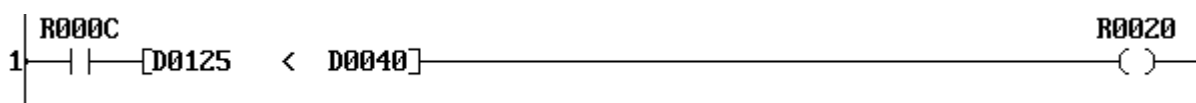

When R00C is ON, the data of D0125 is compared with the data of D0040, and if the data of D0125 is less than the data of D0040, R020 is turned ON.

If the data of D0125 is 10 and that of D0040 is 15, the comparison result is true. Consequently, R020 is turned ON.

D0125 < D0040 \longrightarrow R020 is ON

If the data of D0125 is 0 and that of D0040 is -50, the comparison result is false. Consequently, R020 is turned OFF.

D0125 \geq D0040 \longrightarrow R020 is OFF

Note

- This instruction deals with the data as signed integer (-32768 to 32767).

7. Instructions

FUN 101	<=	Less than or equal
---------	----	--------------------

Expression

Input $\neg[A \leq B]$ – Output

Function

When the input is ON, the data of *A* and the data of *B* are compared, and if *A* is less than or equal to *B*, the output is turned ON.

Execution condition

Input	Operation	Output
OFF	No execution	OFF
ON	Execution	$A \leq B$
		$A > B$

Operand

	Name	Device						Register								Constant	Index		
		X	Y	R	S	T	C	XW	YW	RW	SW	T	C	D	I			J	K
A	Compared data							√	√	√	√	√	√	√	√	√	√	√	√
B	Reference data							√	√	√	√	√	√	√	√	√	√	√	√

Example

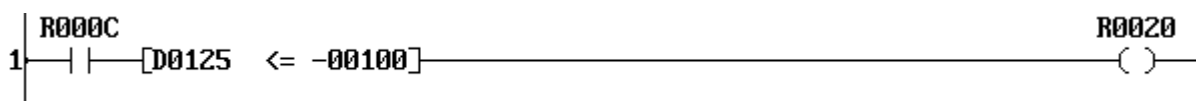

When R00C is ON, the data of D0125 is compared with the constant data -100, and if the data of D0125 is less than or equal to -100, R020 is turned ON.

If the data of D0125 is -150, the comparison result is true. Consequently, R020 is turned ON.

D0125 -150 < Constant -100 \longrightarrow R020 is ON

If the data of D0125 is 0, the comparison result is false. Consequently, R020 is turned OFF.

D0125 0 \geq Constant -100 \longrightarrow R020 is OFF

Note

- This instruction deals with the data as signed integer (-32768 to 32767).

7. Instructions

FUN 102	D>	Double-word greater than
---------	----	--------------------------

Expression

Input $\neg[A+1 \cdot A \text{ D} > B+1 \cdot B]$ – Output

Function

When the input is ON, the double-word data of $A+1 \cdot A$ and $B+1 \cdot B$ are compared, and if $A+1 \cdot A$ is greater than $B+1 \cdot B$, the output is turned ON.

Execution condition

Input	Operation		Output
OFF	No execution		OFF
ON	Execution	$A+1 \cdot A > B+1 \cdot B$	ON
		$A+1 \cdot A \leq B+1 \cdot B$	OFF

Operand

	Name	Device						Register										Constant	Index	
		X	Y	R	S	T	C	XW	YW	RW	SW	T	C	D	I	J	K			
A	Compared data							√	√	√	√	√	√	√					√	
B	Reference data							√	√	√	√	√	√	√					√	

Example

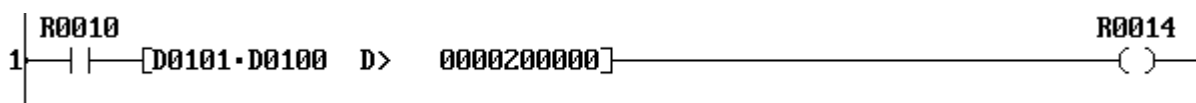

When R010 is ON, the data of D0101·D0100 is compared with the constant data 200000, and if the data of D0101·D0100 is greater than 200000, R014 is turned ON.

If the data of D0101·D0100 is 250000, the comparison result is true. Consequently, R014 is turned ON.

D0101·D0100 > Constant → R014 is ON

If the data of D0101·D0100 is -100, the comparison result is false. Consequently, R014 is turned OFF.

D0101·D0100 ≤ Constant → R014 is OFF

Note

- This instruction deals with the data as double-word integer (-2147483648 to 2147483647).

7. Instructions

FUN 103	D>=	Double-word greater than or equal
---------	-----	-----------------------------------

Expression

Input $\neg[A+1 \cdot A \text{ D}>= B+1 \cdot B]$ – Output

Function

When the input is ON, the double-word data of $A+1 \cdot A$ and $B+1 \cdot B$ are compared, and if $A+1 \cdot A$ is greater than or equal to $B+1 \cdot B$, the output is turned ON.

Execution condition

Input	Operation	Output
OFF	No execution	OFF
ON	Execution	$A+1 \cdot A \geq B+1 \cdot B$
		$A+1 \cdot A < B+1 \cdot B$
		OFF

Operand

	Name	Device						Register								Constant	Index		
		X	Y	R	S	T	C	XW	YW	RW	SW	T	C	D	I			J	K
A	Compared data							√	√	√	√	√	√	√				√	
B	Reference data							√	√	√	√	√	√	√				√	

Example

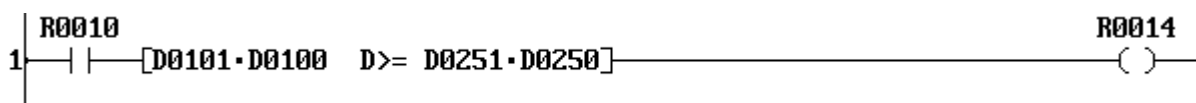

When R010 is ON, the double-word data of D0101·D0100 is compared with the double-word data of D0251·D0250, and if the data of D0101·D0100 is greater than or equal to the data of D0251·D0250, R014 is turned ON.

If the data of D0101·D0100 is 250000 and D0251·D0250 is 200000, R014 is turned ON.

D0101·D0100 250000 \geq D0251·D0250 200000 \longrightarrow R014 is ON

If the data of D0101·D0100 is -100 and D0251·D0250 is 0, R014 is turned OFF.

D0101·D0100 -100 $<$ D0251·D0250 0 \longrightarrow R014 is OFF

Note

- This instruction deals with the data as double-word integer (-2147483648 to 2147483647).

7. Instructions

FUN 104	D=	Double-word equal
---------	----	-------------------

Expression

Input $\neg [A+1 \cdot A \text{ D=} B+1 \cdot B]$ – Output

Function

When the input is ON, the double-word data of $A+1 \cdot A$ and $B+1 \cdot B$ are compared, and if $A+1 \cdot A$ is equal to $B+1 \cdot B$, the output is turned ON.

Execution condition

Input	Operation		Output
OFF	No execution		OFF
ON	Execution	$A+1 \cdot A = B+1 \cdot B$	ON
		$A+1 \cdot A \neq B+1 \cdot B$	OFF

Operand

	Name	Device						Register								Constant	Index		
		X	Y	R	S	T	C	XW	YW	RW	SW	T	C	D	I			J	K
A	Compared data							√	√	√	√	√	√	√				√	
B	Reference data							√	√	√	√	√	√	√				√	

Example

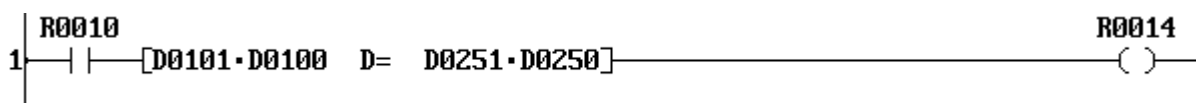

When R010 is ON, the double-word data of D0101·D0100 is compared with the double-word data of D0251·D0250, and if the data of D0101·D0100 is equal to the data of D0251·D0250, R014 is turned ON.

If the data of D0101·D0100 is 250000 and D0251·D0250 is 250000, R014 is turned ON.

D0101·D0100 = D0251·D0250 → R014 is ON

If the data of D0101·D0100 is -100 and D0251·D0250 is 0, R014 is turned OFF.

D0101·D0100 ≠ D0251·D0250 → R014 is OFF

Note

- This instruction deals with the data as double-word integer (-2147483648 to 2147483647).

7. Instructions

FUN 105	D<>	Double-word not equal
---------	-----	-----------------------

Expression

Input $\neg[A+1 \cdot A \text{ D} \langle \rangle B+1 \cdot B]$ – Output

Function

When the input is ON, the double-word data of $A+1 \cdot A$ and $B+1 \cdot B$ are compared, and if $A+1 \cdot A$ is not equal to $B+1 \cdot B$, the output is turned ON.

Execution condition

Input	Operation	Output
OFF	No execution	OFF
ON	Execution	$A+1 \cdot A \neq B+1 \cdot B$
		$A+1 \cdot A = B+1 \cdot B$
		ON
		OFF

Operand

	Name	Device						Register								Constant	Index		
		X	Y	R	S	T	C	XW	YW	RW	SW	T	C	D	I			J	K
A	Compared data							√	√	√	√	√	√	√				√	
B	Reference data							√	√	√	√	√	√	√				√	

Example

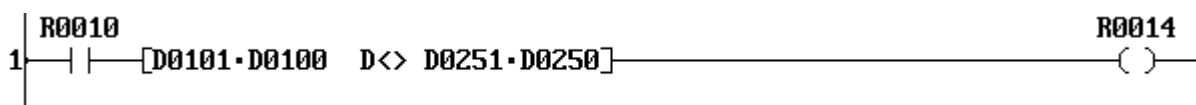

When R010 is ON, the double-word data of D0101·D0100 is compared with the double-word data of D0251·D0250, and if the data of D0101·D0100 is not equal to the data of D0251·D0250, R014 is turned ON.

If the data of D0101·D0100 is 250000 and D0251·D0250 is 200000, R014 is turned ON.

D0101·D0100 250000 \neq D0251·D0250 250000 \longrightarrow R014 is ON

If the data of D0101·D0100 is -100 and D0251·D0250 is -100, R014 is turned OFF.

D0101·D0100 -100 $=$ D0251·D0250 -100 \longrightarrow R014 is OFF

Note

- This instruction deals with the data as double-word integer (-2147483648 to 2147483647).

7. Instructions

FUN 106	D<	Double-word less than
---------	----	-----------------------

Expression

Input $\neg[A+1 \cdot A \text{ D} < B+1 \cdot B]$ – Output

Function

When the input is ON, the double-word data of $A+1 \cdot A$ and $B+1 \cdot B$ are compared, and if $A+1 \cdot A$ is less than $B+1 \cdot B$, the output is turned ON.

Execution condition

Input	Operation		Output
OFF	No execution		OFF
ON	Execution	$A+1 \cdot A < B+1 \cdot B$	ON
		$A+1 \cdot A \geq B+1 \cdot B$	OFF

Operand

	Name	Device						Register								Constant	Index		
		X	Y	R	S	T	C	XW	YW	RW	SW	T	C	D	I			J	K
A	Compared data							√	√	√	√	√	√	√				√	
B	Reference data							√	√	√	√	√	√	√				√	

Example

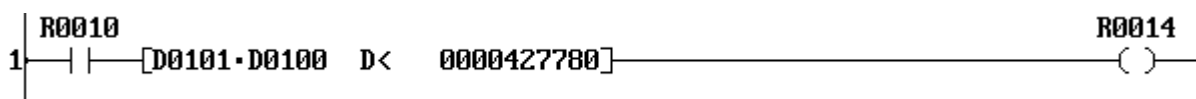

When R010 is ON, the data of D0101·D0100 is compared with the constant data 427780, and if the data of D0101·D0100 is less than 427780, R014 is turned ON.

If the data of D0101·D0100 is 250000, R014 is turned ON.

D0101·D0100 < Constant → R014 is ON

If the data of D0101·D0100 is 430000, R014 is turned OFF.

D0101·D0100 ≥ Constant → R014 is OFF

Note

- This instruction deals with the data as double-word integer (-2147483648 to 2147483647).

7. Instructions

FUN 107	D<=	Double-word less than or equal
---------	-----	--------------------------------

Expression

Input $\neg[A+1 \cdot A \text{ D} \leq B+1 \cdot B]$ Output

Function

When the input is ON, the double-word data of $A+1 \cdot A$ and $B+1 \cdot B$ are compared, and if $A+1 \cdot A$ is less than or equal to $B+1 \cdot B$, the output is turned ON.

Execution condition

Input	Operation	Output
OFF	No execution	OFF
ON	Execution	$A+1 \cdot A \leq B+1 \cdot B$
		$A+1 \cdot A > B+1 \cdot B$
		ON
		OFF

Operand

	Name	Device						Register								Constant	Index		
		X	Y	R	S	T	C	XW	YW	RW	SW	T	C	D	I			J	K
A	Compared data							√	√	√	√	√	√	√				√	
B	Reference data							√	√	√	√	√	√	√				√	

Example

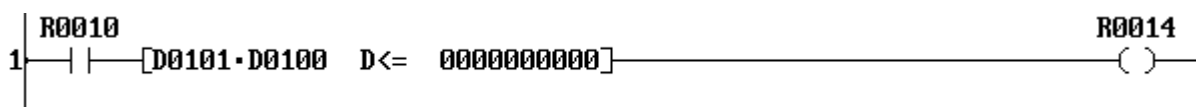

When R010 is ON, the data of D0101·D0100 is compared with the constant data 0, and if the data of D0101·D0100 is less than or equal to 0, R014 is turned ON.

If the data of D0101·D0100 is -1, R014 is turned ON.

D0101·D0100 -1 ≤ Constant 0 → R014 is ON

If the data of D0101·D0100 is 10000, R014 is turned OFF.

D0101·D0100 10000 > Constant 0 → R014 is OFF

Note

- This instruction deals with the data as double-word integer (-2147483648 to 2147483647).

7. Instructions

FUN 108	U>	Unsigned greater than
---------	----	-----------------------

Expression

Input $\neg[A \text{ U} > B]$ – Output

Function

When the input is ON, the data of *A* and the data of *B* are compared, and if *A* is greater than *B*, the output is turned ON.

Execution condition

Input	Operation		Output
OFF	No execution		OFF
ON	Execution	$A > B$	ON
		$A \leq B$	OFF

Operand

	Name	Device						Register								Constant	Index		
		X	Y	R	S	T	C	XW	YW	RW	SW	T	C	D	I			J	K
A	Compared data							√	√	√	√	√	√	√	√	√	√	√	√
B	Reference data							√	√	√	√	√	√	√	√	√	√	√	√

Example

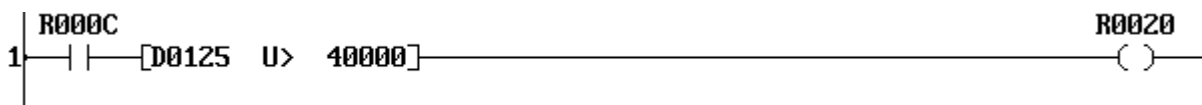

When R00C is ON, the data of D0125 is compared with the constant data 40000, and if the data of D0125 is greater than 40000, R020 is turned ON.

If the data of D0125 is 52000, the comparison result is true. Consequently, R020 is turned ON.

D0125 52000 > Constant 40000 → R020 is ON

If the data of D0125 is 21000, the comparison result is false. Consequently, R020 is turned OFF.

D0125 21000 ≤ Constant 40000 → R020 is OFF

Note

- This instruction deals with the data as unsigned integer (0 to 65535).

7. Instructions

FUN 109	U>=	Unsigned greater than or equal
---------	-----	--------------------------------

Expression

Input $\neg[A \geq B]$ – Output

Function

When the input is ON, the data of *A* and the data of *B* are compared, and if *A* is greater than or equal to *B*, the output is turned ON.

Execution condition

Input	Operation	Output
OFF	No execution	OFF
ON	Execution	$A \geq B$
		$A < B$

Operand

	Name	Device						Register								Constant	Index		
		X	Y	R	S	T	C	XW	YW	RW	SW	T	C	D	I			J	K
A	Compared data							√	√	√	√	√	√	√	√	√	√	√	√
B	Reference data							√	√	√	√	√	√	√	√	√	√	√	√

Example

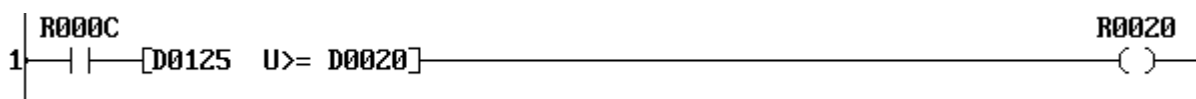

When R00C is ON, the data of D0125 is compared with the data of D0020, and if the data of D0125 is greater than or equal to the data of D0020, R020 is turned ON.

If the data of D0125 is 40000 and that of D0020 is 40000, the comparison result is true. Consequently, R020 is turned ON.

D0125 40000 \geq D0020 40000 \longrightarrow R020 is ON

If the data of D0125 is 15000 and that of D0020 is 20000, the comparison result is false. Consequently, R020 is turned OFF.

D0125 15000 $<$ D0020 20000 \longrightarrow R020 is OFF

Note

- This instruction deals with the data as unsigned integer (0 to 65535).

7. Instructions

FUN 110	U=	Unsigned equal
---------	----	----------------

Expression

Input $\neg[A \text{ U= } B]$ – Output

Function

When the input is ON, the data of *A* and the data of *B* are compared, and if *A* is equal to *B*, the output is turned ON.

Execution condition

Input	Operation	Output	
OFF	No execution	OFF	
ON	Execution	$A = B$	ON
		$A \neq B$	OFF

Operand

	Name	Device						Register								Constant	Index		
		X	Y	R	S	T	C	XW	YW	RW	SW	T	C	D	I			J	K
A	Compared data							√	√	√	√	√	√	√	√	√	√	√	√
B	Reference data							√	√	√	√	√	√	√	√	√	√	√	√

Example

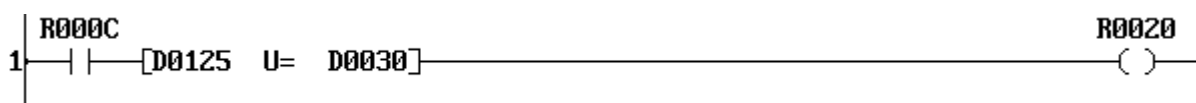

When R00C is ON, the data of D0125 is compared with the data of D0030, and if the data of D0125 is equal to the data of D0030, R020 is turned ON.

If the data of D0125 is 35000 and that of D0020 is 35000, the comparison result is true. Consequently, R020 is turned ON.

D0125 35000 = D0030 35000 \longrightarrow R020 is ON

If the data of D0125 is 1500 and that of D0020 is 4000, the comparison result is false. Consequently, R020 is turned OFF.

D0125 1500 \neq D0030 4000 \longrightarrow R020 is OFF

Note

- This instruction deals with the data as unsigned integer (0 to 65535).

7. Instructions

FUN 111	U<>	Unsigned not equal
---------	-----	--------------------

Expression

Input $\neg[A \text{ U}<> B]$ – Output

Function

When the input is ON, the data of *A* and the data of *B* are compared, and if *A* is not equal to *B*, the output is turned ON.

Execution condition

Input	Operation	Output
OFF	No execution	OFF
ON	Execution	$A \neq B$
		$A = B$
		ON
		OFF

Operand

	Name	Device						Register								Constant	Index		
		X	Y	R	S	T	C	XW	YW	RW	SW	T	C	D	I			J	K
A	Compared data							√	√	√	√	√	√	√	√	√	√	√	√
B	Reference data							√	√	√	√	√	√	√	√	√	√	√	√

Example

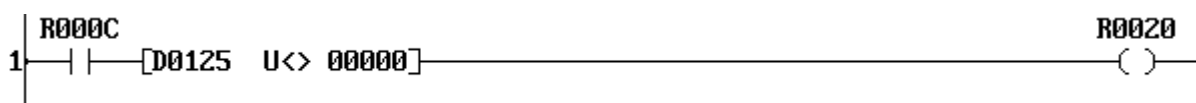

When R00C is ON, the data of D0125 is compared with the constant data 0, and if the data of D0125 is not 0, R020 is turned ON.

If the data of D0125 is 41000, the comparison result is true. Consequently, R020 is turned ON.

D0125 41000 \neq Constant 0 \longrightarrow R020 is ON

If the data of D0125 is 0, the comparison result is false. Consequently, R020 is turned OFF.

D0125 0 $=$ Constant 0 \longrightarrow R020 is OFF

Note

- This instruction deals with the data as unsigned integer (0 to 65535).

7. Instructions

FUN 112	U<	Unsigned less than
---------	----	--------------------

Expression

Input $\neg[A \text{ U} < B]$ – Output

Function

When the input is ON, the data of *A* and the data of *B* are compared, and if *A* is less than *B*, the output is turned ON.

Execution condition

Input	Operation		Output
OFF	No execution		OFF
ON	Execution	$A < B$	ON
		$A \geq B$	OFF

Operand

	Name	Device						Register								Constant	Index		
		X	Y	R	S	T	C	XW	YW	RW	SW	T	C	D	I			J	K
A	Compared data							√	√	√	√	√	√	√	√	√	√	√	√
B	Reference data							√	√	√	√	√	√	√	√	√	√	√	√

Example

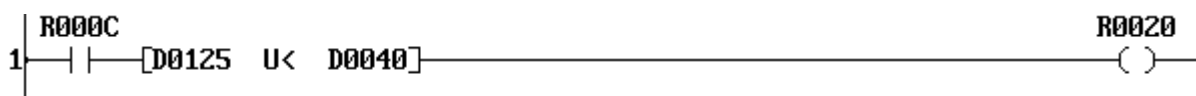

When R00C is ON, the data of D0125 is compared with the data of D0040, and if the data of D0125 is less than the data of D0040, R020 is turned ON.

If the data of D0125 is 43000 and that of D0040 is 45000, the comparison result is true. Consequently, R020 is turned ON.

D0125 43000 < D0040 45000 \longrightarrow R020 is ON

If the data of D0125 is 50000 and that of D0040 is 50000, the comparison result is false. Consequently, R020 is turned OFF.

D0125 50000 \geq D0040 50000 \longrightarrow R020 is OFF

Note

- This instruction deals with the data as unsigned integer (0 to 65535).

7. Instructions

FUN 113	U<=	Unsigned less than or equal
---------	-----	-----------------------------

Expression

Input $\neg[A \text{ U} \leq B]$ – Output

Function

When the input is ON, the data of *A* and the data of *B* are compared, and if *A* is less than or equal to *B*, the output is turned ON.

Execution condition

Input	Operation	Output
OFF	No execution	OFF
ON	Execution	$A \leq B$
		$A > B$

Operand

	Name	Device						Register								Constant	Index		
		X	Y	R	S	T	C	XW	YW	RW	SW	T	C	D	I			J	K
A	Compared data							√	√	√	√	√	√	√	√	√	√	√	√
B	Reference data							√	√	√	√	√	√	√	√	√	√	√	√

Example

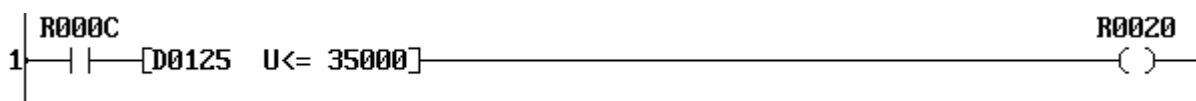

When R00C is ON, the data of D0125 is compared with the constant data 35000, and if the data of D0125 is less than or equal to 35000, R020 is turned ON.

If the data of D0125 is 35000, the comparison result is true. Consequently, R020 is turned ON.

D0125 35000 ≤ Constant 35000 → R020 is ON

If the data of D0125 is 0, the comparison result is false. Consequently, R020 is turned OFF.

D0125 38000 > Constant 35000 → R020 is OFF

Note

- This instruction deals with the data as unsigned integer (0 to 65535).

7. Instructions

FUN 114	SET	Device/register set
---------	-----	---------------------

Expression

Input \neg [SET A]– Output

Function

When the input is ON, the device *A* is set to ON if *A* is a device, or the data HFFFF is stored in the register *A* if *A* is a register.

Execution condition

Input	Operation	Output
OFF	No execution	OFF
ON	Execution	ON

Operand

	Name	Device						Register										Constant	Index
		X	Y	R	S	T.	C.	XW	YW	RW	SW	T	C	D	I	J	K		
A	Device or register		√	√	√				√	√	√	√	√	√	√	√	√		

Example 1 (device set)

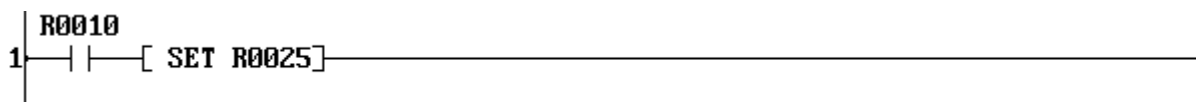

When R010 is ON, R025 is set to ON. The state of R025 is remained even if R010 comes OFF.

Example 2 (register set)



When R010 is ON, the data HFFFF is stored in RW20. (R200 to R20F are set to ON)
The state of RW20 is remained even if R010 comes OFF.

7. Instructions

FUN 115	RST	Device/register reset
---------	-----	-----------------------

Expression

Input \neg [RST A] \neg Output

Function

When the input is ON, the device A is reset to OFF if A is a device, or the data 0 is stored in the register A if A is a register.

Execution condition

Input	Operation	Output
OFF	No execution	OFF
ON	Execution	ON

Operand

	Name	Device						Register										Constant	Index
		X	Y	R	S	T.	C.	XW	YW	RW	SW	T	C	D	I	J	K		
A	Device or register		√	√	√				√	√	√	√	√	√	√	√	√		

Example 1 (device reset)



When R011 is ON, R005 is reset to OFF. The state of R025 is remained even if R011 comes OFF.

Example 2 (register reset)

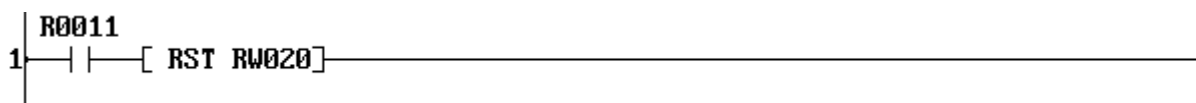

When R011 is ON, the data 0 is stored in RW20. (R200 to R20F are reset to OFF)
The state of RW20 is remained even if R011 comes OFF.

7. Instructions

FUN 118	SETC	Set carry
---------	------	-----------

Expression

Input \neg [SETC] \neg Output

Function

When the input is ON, the carry flag (CF = S050) is set to ON.

Execution condition

Input	Operation	Output	CF
OFF	No execution	OFF	–
ON	Execution	ON	Set

Operand

No operand is required.

Example

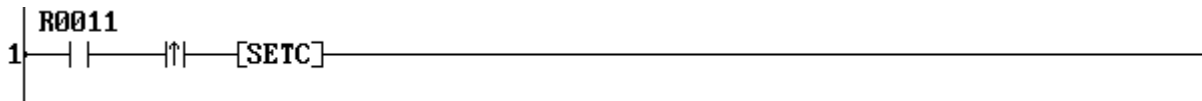

When R011 is changed from OFF to ON, the carry flag S050 is set to ON.

7. Instructions

FUN 119	RSTC	Reset carry
---------	------	-------------

Expression

Input \neg [RSTC] \neg Output

Function

When the input is ON, the carry flag (CF = S050) is reset to OFF.

Execution condition

Input	Operation	Output	CF
OFF	No execution	OFF	–
ON	Execution	ON	Reset

Operand

No operand is required.

Example

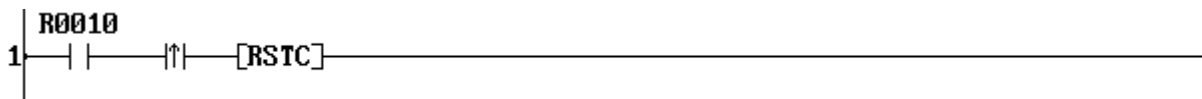

When R010 is changed from OFF to ON, the carry flag S050 is reset to OFF.

7. Instructions

FUN 120	ENC	Encode
---------	-----	--------

Expression

Input $\neg[A \text{ ENC } (n) B]$ – Output

Function

When the input is ON, this instruction finds the bit position of the most significant ON bit in the bit table, size 2^n bits starting with 0 bit (LSB) of A , and stores it in B .

Execution condition

Input	Operation	Output	ERF
OFF	No execution	OFF	–
ON	Normal execution	ON	–
	There is no ON bit (no execution)	OFF	Set

Operand

	Name	Device						Register								Constant	Index		
		X	Y	R	S	T	C	XW	YW	RW	SW	T	C	D	I			J	K
A	Start of table							√	√	√	√	√	√	√					
n	Table size																		1 - 8
B	Encode result								√	√	√	√	√	√	√	√	√	√	

Example

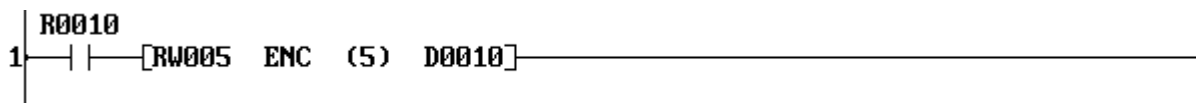

2^5 (=32) bits starting with 0 bit of RW05 (R050 to R06F) are defined as the bit table. When R010 is ON, the most significant ON (1) bit position in the bit table is searched, and the position is stored in D0010.

The following figure shows an operation example.

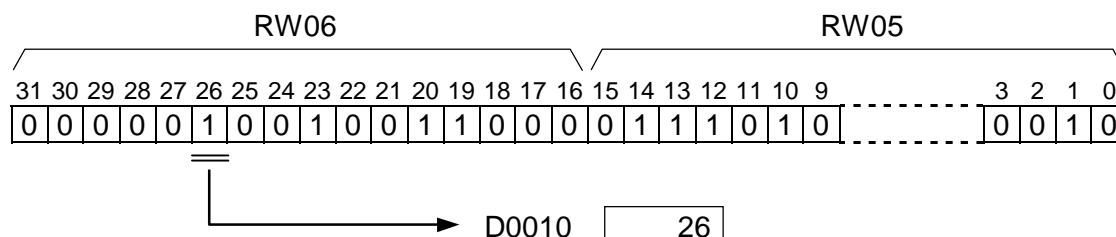

Note

- If there is no ON bit in the bit table, the instruction error flag (ERF = S051) is set to ON.

7. Instructions

FUN 121	DEC	Decode
---------	-----	--------

Expression

Input $\text{--[} A \text{ DEC } (n) B \text{]--}$ Output

Function

When the input is ON, this instruction sets the bit position which is designated by lower n bits of A to ON in the bit table, size 2^n bits starting with 0 bit (LSB) of B , and resets all other bits to OFF.

Execution condition

Input	Operation	Output
OFF	No execution	OFF
ON	Execution	ON

Operand

	Name	Device						Register										Constant	Index
		X	Y	R	S	T	C	XW	YW	RW	SW	T	C	D	I	J	K		
A	Decode source							√	√	√	√	√	√	√	√	√	√		
n	Table size																		1 - 8
B	Start of table								√	√	√	√	√	√					

Example

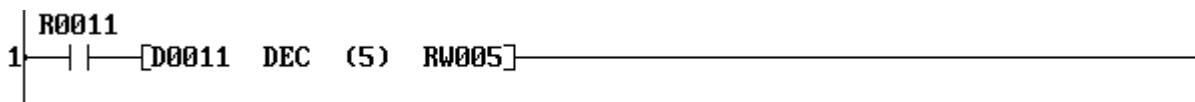

$2^5 (=32)$ bits starting with 0 bit of RW05 (R050 to R06F) are defined as the bit table.
 When R011 is ON, the bit position designated by lower 5 bits of D0011 in the bit table is set to ON, and all other bits in the table are reset to OFF.
 The following figure shows an operation example.

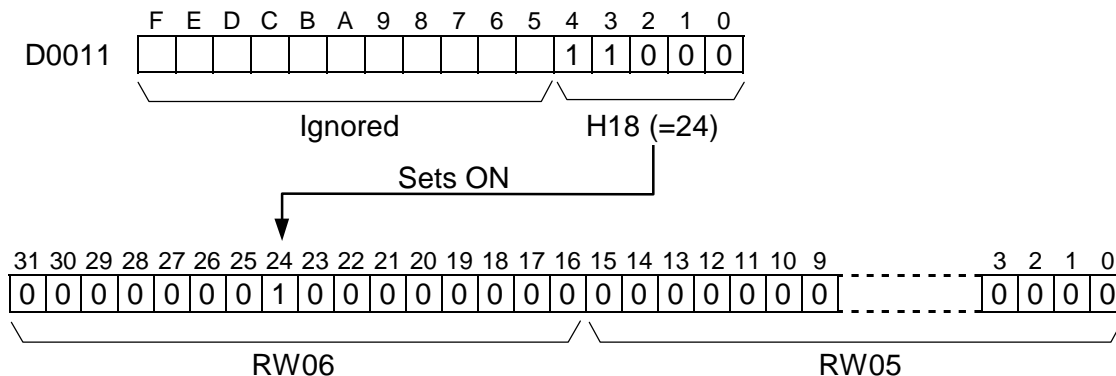

7. Instructions

FUN 122	BC	Bit count
---------	----	-----------

Expression

Input $\text{--}[A \text{ BC } B]\text{--}$ Output

Function

When the input is ON, this instruction counts the number of ON (1) bits of A, and stores the result in B.

Execution condition

Input	Operation	Output
OFF	No execution	OFF
ON	Execution	ON

Operand

	Name	Device						Register										Constant	Index		
		X	Y	R	S	T	C	XW	YW	RW	SW	T	C	D	I	J	K				
A	Source							√	√	√	√	√	√	√	√	√	√			√	
B	Count data								√	√	√	√	√	√							

Example

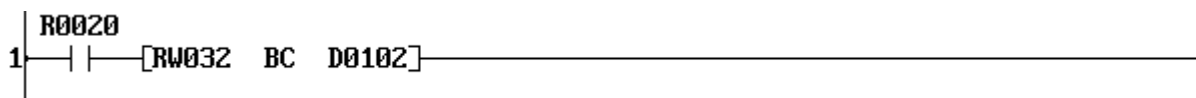

When R020 is ON, the number of ON (1) bits of the register RW032 is counted, and the result is stored in D0102.

The following figure shows an operation example.

	F	E	D	C	B	A	9	8	7	6	5	4	3	2	1	0
RW032	0	0	1	0	0	1	1	1	0	1	0	1	1	0	0	0

Counts the number of ON (1) bits = 7

	F	E	D	C	B	A	9	8	7	6	5	4	3	2	1	0
D0102	0	0	0	0	0	0	0	0	0	0	0	0	0	1	1	1

The result data (7) is stored in binary

7. Instructions

FUN 128	CALL	Subroutine call
---------	------	-----------------

Expression

Input \neg [CALL N. n]– Output

Function

When the input is ON, this instruction calls the subroutine number n .

Execution condition

Input	Operation	Output
OFF	No execution	OFF
ON	Execution	ON

Operand

	Name	Device						Register								Constant	Index		
		X	Y	R	S	T	C	XW	YW	RW	SW	T	C	D	I			J	K
n	Subroutine number																	\surd (Note)	

Example



When X007 is ON, the subroutine number 8 is called. When the program execution is returned from the subroutine, the output is turned ON.

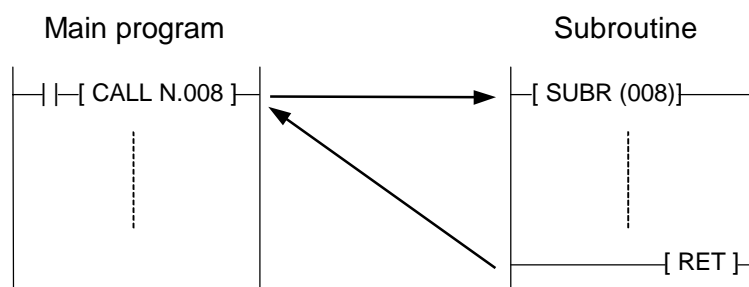

Note

- The possible subroutine number is 0 to 15 (T1) or 0 to 255 (T1S).
- Refer to the SUBR instruction (FUN 137).
- In case of T1, nesting of subroutines is not allowed. That is, the CALL instruction cannot be used in a subroutine.
- In case of T1S, nesting of subroutines is possible. (up to 3 levels)
- The CALL instruction can be used in an interrupt program. However, it is not allowed that the same subroutine is called from an interrupt program and from main program.

7. Instructions

FUN 129	RET	Subroutine return
---------	-----	-------------------

Expression

|-[RET]|

Function

This instruction indicates the end of a subroutine. When program execution is reached this instruction, it is returned to the original CALL instruction.

Execution condition

Input	Operation	Output
-	Execution	-

Operand

No operand is required.

Example

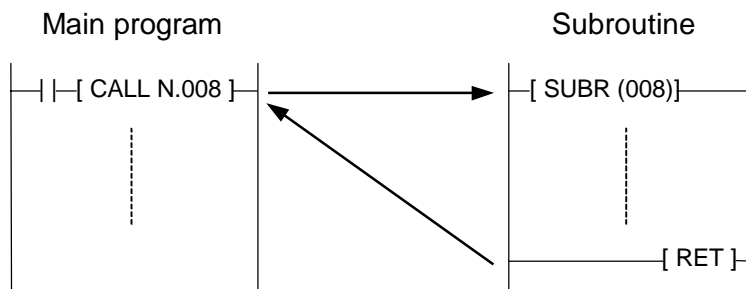
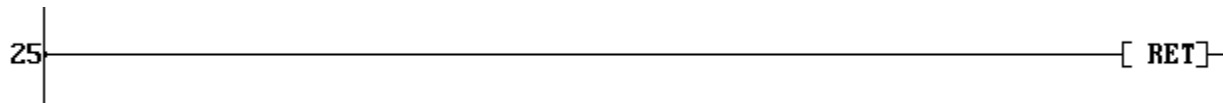

Note

- Refer to the SUBR instruction (FUN 137).
- The RET instruction can be programmed only in the program type 'Subroutine'.
- The RET instruction must be connected directly to the left power rail.

7. Instructions

FUN 132	FOR	FOR (FOR-NEXT loop)
---------	-----	---------------------

Expression

Input \neg [FOR n]- Output

Function

When the input is ON, the program segment between FOR and NEXT is executed n times repeatedly in a scan.

When the input is OFF, the repetition is not performed. (the segment is executed once)

Execution condition

Input	Operation	Output
OFF	No repetition	OFF
ON	Repetition	ON

Operand

	Name	Device						Register										Constant	Index
		X	Y	R	S	T	C.	XW	YW	RW	SW	T	C	D	I	J	K		
n	Repetition times							√	√	√	√	√	√	√	√	√	√	1 - 32767	

Example

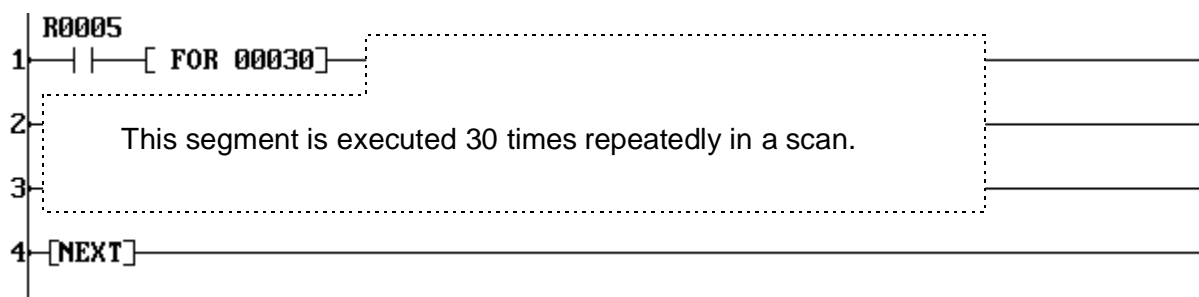

When R005 is ON, the program segment between FOR and NEXT is executed 30 times in a scan.

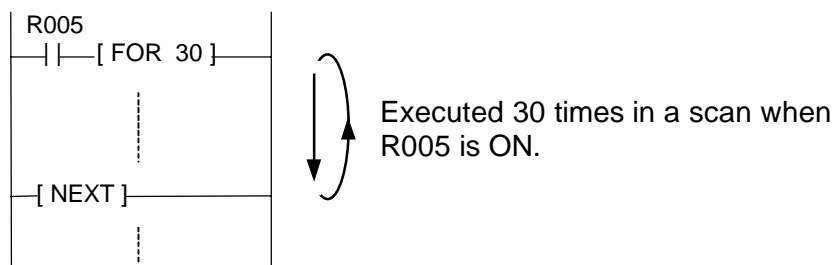

7. Instructions

FUN 133	NEXT	NEXT (FOR-NEXT loop)
---------	------	----------------------

Expression

Input \neg [NEXT] \neg Output

Function

This instruction configures a FOR-NEXT loop.

If the input is OFF, The repetition is forcibly broken. and the program execution is moved to the next instruction.

Execution condition

Input	Operation	Output
OFF	Forcibly breaks the repetition	OFF
ON	Repetition	ON

Operand

No operand is required.

Example

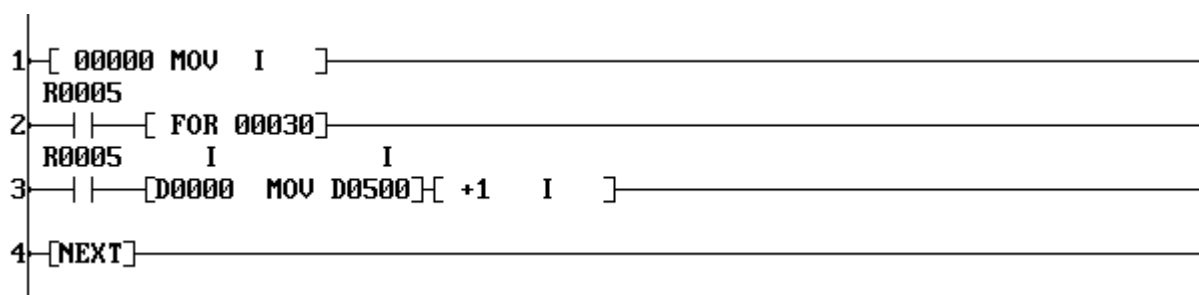

When R005 is ON, the program segment between FOR and NEXT is executed 30 times in a scan. In the above example, the rung 3 is executed 30 times. As a result, the data of D0000 to D0029 are transferred to D0500 to D0529. (Block transfer)

Note

- The FOR instruction must be used with a corresponding NEXT instruction one by one.
- Nesting of the FOR-NEXT loop is not allowed. That is, the FOR instruction cannot be used in a FOR-NEXT loop.
- The FOR and NEXT instructions cannot be programmed on the same rung.
- The following connection is not allowed.



7. Instructions

FUN 137	SUBR	Subroutine entry
---------	------	------------------

Expression

$\text{1} \text{---} [\text{SUBR } (n)] \text{---}$

Function

This instruction indicates the begging of a subroutine.

Execution condition

Input	Operation	Output
-	Execution	-

Operand

	Name	Device						Register								Constant	Index		
		X	Y	R	S	T	C	XW	YW	RW	SW	T	C	D	I			J	K
<i>n</i>	Subroutine number																	√ (Note)	

Example

$\text{1} \text{---} [\text{SUBR}(008)] \text{---}$

The begging of the subroutine number 8 is indicated.

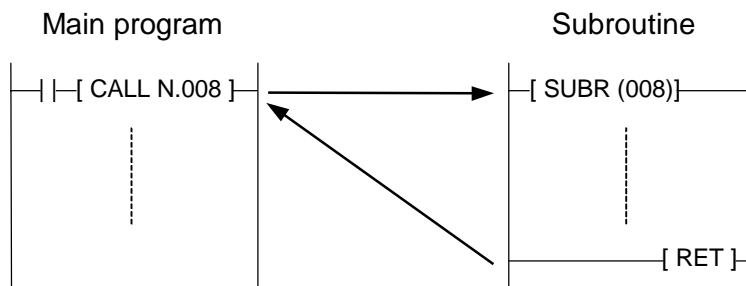

Note

- The possible subroutine number is 0 to 15 (T1) or 0 to 255 (T1S).
- Refer to the CALL instruction (FUN 128) and the RET instruction (FUN 129).
- The SUBR instruction can be programmed only in the program type 'Subroutine'.
- Nesting of subroutine is not allowed. That is, the CALL instruction cannot be used in a subroutine.
- No other instruction cannot be placed on the rung of the SUBR instruction.

7. Instructions

FUN 140	EI	Enable interrupt
---------	----	------------------

Expression

Input \neg [EI]- Output

Function

When the input is ON, this instruction enables the execution of user designated interrupt operation, i.e. timer interrupt program and I/O interrupt programs.

Execution condition

Input	Operation	Output
OFF	No execution	OFF
ON	Execution	ON

Operand

No operand is required.

Example

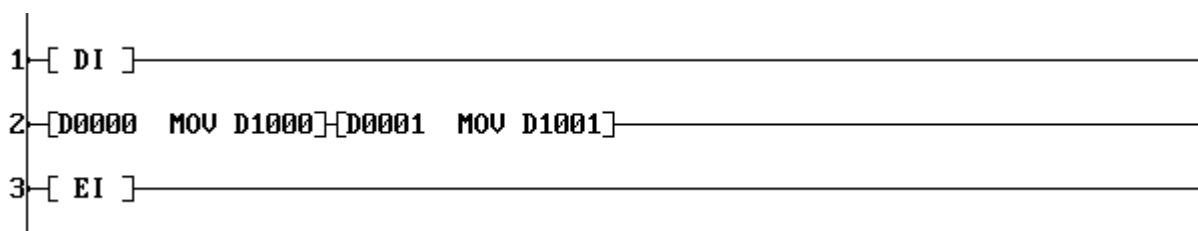

In the above example, the DI instruction disables the interrupt. Then the EI instruction enables the interrupt again. As a result, the rung 2 instructions can be executed without interruption between each instructions.

Note

- Refer to the DI instruction (FUN 141).
- If an interrupt factor is occurred during the interrupt disabled state, the interrupt is kept waiting and it will be executed just after the EI instruction is executed.
- The EI instruction can be used only in the main program.

7. Instructions

FUN 141	DI	Disable interrupt
---------	----	-------------------

Expression

Input \neg [DI]– Output

Function

When the input is ON, this instruction disables the execution of user designated interrupt operation, i.e. timer interrupt program and I/O interrupt programs.

Execution condition

Input	Operation	Output
OFF	No execution	OFF
ON	Execution	ON

Operand

No operand is required.

Example

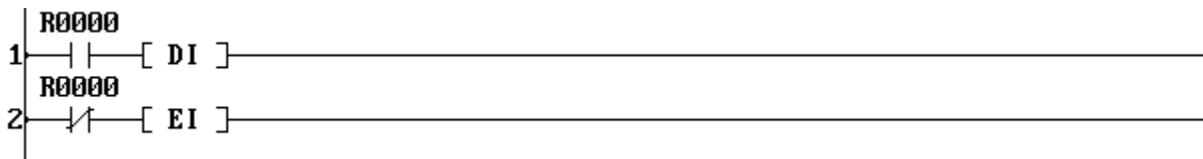

In the above example, the interrupt is disabled when R000 is ON, and it is enabled when R000 is OFF.

Note

- Refer to the EI instruction (FUN 140).
- If an interrupt factor is occurred during the interrupt disabled state, the interrupt is kept waiting and it will be executed just after the EI instruction is executed.
- The DI instruction can be used only in the main program.

7. Instructions

FUN 142	IRET	Interrupt return
---------	------	------------------

Expression

┌─[IRET]─┐

Function

This instruction indicates the end of an interrupt program. When program execution reaches this instruction, it returns to the original location of the main program (or subroutine).

Execution condition

Input	Operation	Output
-	Execution	-

Operand

No operand is required.

Example

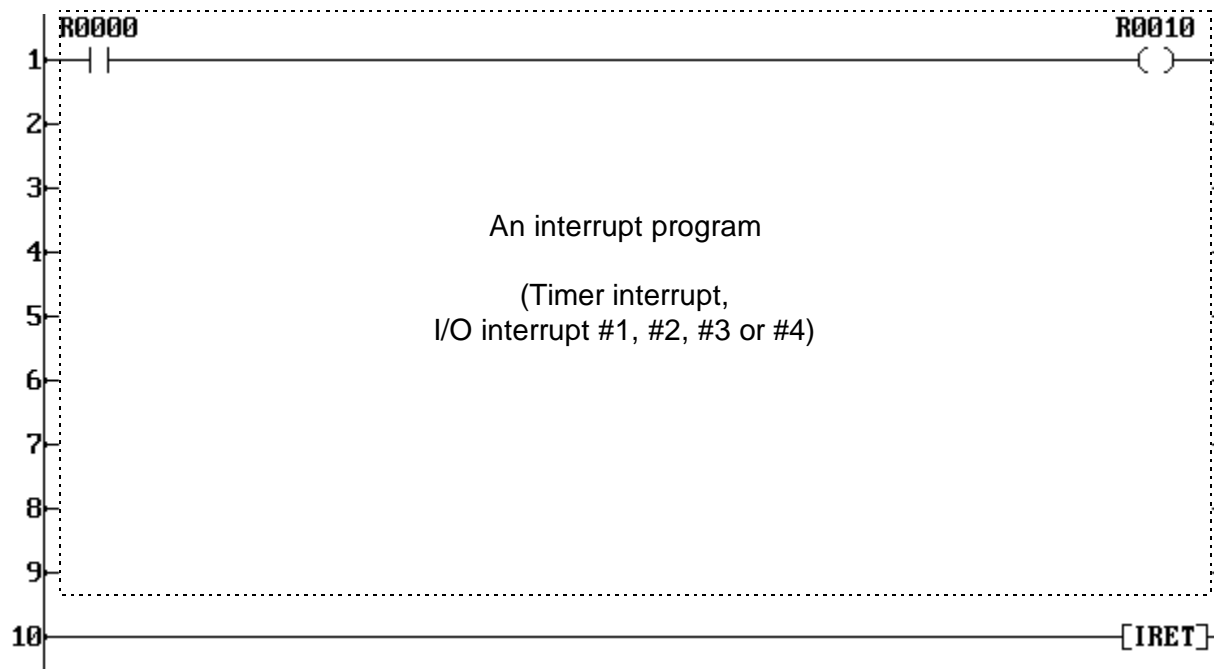

Note

- The IRET instruction can be used only in an interrupt program.
- There is no specific instruction which indicates the beginning of the interrupt program.

7. Instructions

FUN 143	WDT	Watchdog timer reset
---------	-----	----------------------

Expression

Input $-\text{[WDT } n \text{]}$ – Output

Function

When the input is ON, this instruction extend the scan time over detection time by 200 ms. Normally, T1/T1S detects the scan time-over if a scan is not finished within 200 ms. This instruction can be used to extend the detection time.

Execution condition

Input	Operation	Output
OFF	No execution	OFF
ON	Execution	ON

Operand

	Name	Device						Register							Constant	Index			
		X	Y	R	S	T	C	XW	YW	RW	SW	T	C	D			I	J	K
n	Extend time																	1 - 100	

Example

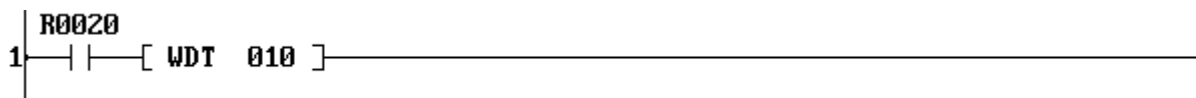

When R020 is ON, the scan time detection time is extended by 200 ms. The operand n has no effect on the extended time. It is fixed as 200 ms.

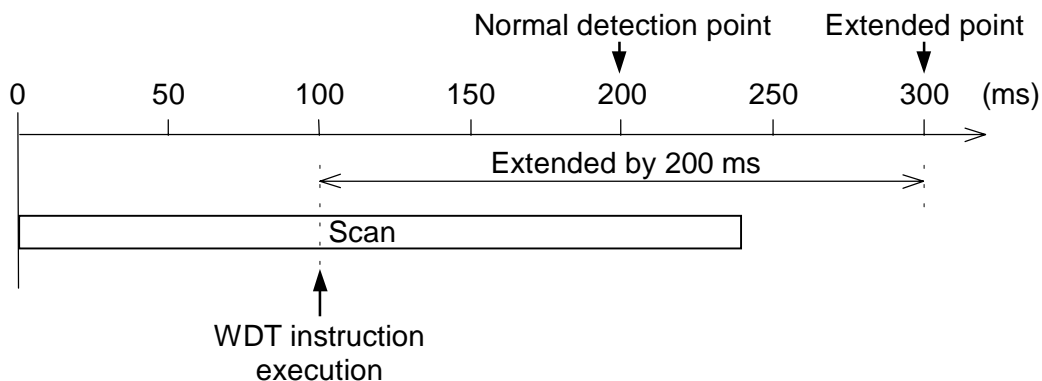

Note

- As for the upper T-series PLCs, the operand n specifies the extended time. However in the T1/T1S, it is fixed as 200 ms regardless of the operand n .

7. Instructions

FUN 144	STIZ	Step sequence initialize
---------	------	--------------------------

Expression

Input \neg [STIZ (*n*) A]– Output

Function

When the input is ON, *n* devices starting with *A* are reset to OFF, and *A* is set to ON.

This instruction is used to initialize a series of step sequence. The step sequence is useful to describe a sequential operation.

Execution condition

Input	Operation	Output
OFF	No execution	OFF
ON	Execution at the rising edge of the input	ON

Operand

	Name	Device						Register								Constant	Index			
		X	Y	R	S	T	C	XW	YW	RW	SW	T	C	D	I			J	K	
<i>n</i>	Size of step sequence																		1 - 64	
<i>A</i>	Start device			√																

Example

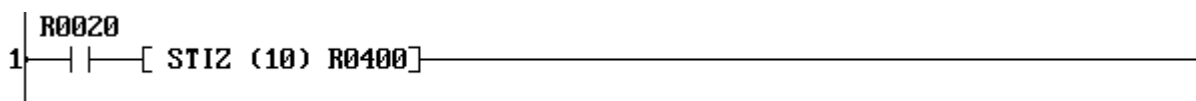

When R020 is changed from OFF to ON, R400 is set to ON and subsequent 9 devices (R401 to R409) are reset to OFF.

This instruction initializes a series of step sequence, 10 devices starting with R400.

R409	R408	R407	R406	R405	R404	R403	R402	R401	R400
OFF	OFF	OFF	OFF	OFF	OFF	OFF	OFF	OFF	ON

10 devices starting with R400

Note

- The STIZ instruction is used together with STIN (FUN 145) and STOT (FUN 146) instructions to configure the step sequence.
- The STIZ instruction is executed only when the input is changed from OFF to ON.

7. Instructions

FUN 145	STIN	Step sequence input
---------	------	---------------------

Expression

Input \neg [STIN A] \neg Output

Function

When the input is ON and the device *A* is ON, the output is set to ON.

Execution condition

Input	Operation	Output
OFF	No execution	OFF
ON	When <i>A</i> is ON	ON
	When <i>A</i> is OFF	OFF

Operand

	Name	Device						Register										Constant	Index	
		X	Y	R	S	T	C	XW	YW	RW	SW	T	C	D	I	J	K			
A	Step device			√																

Example

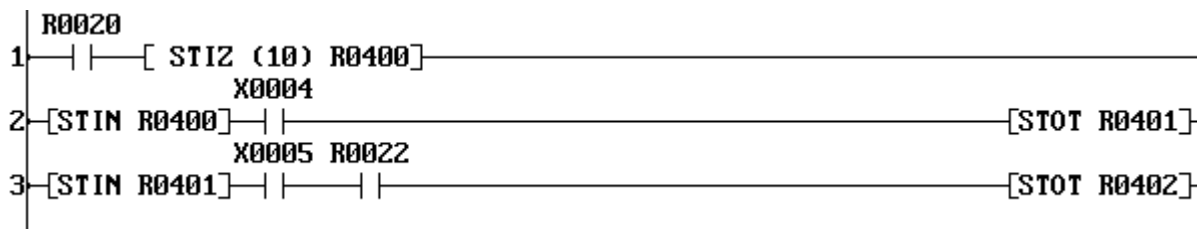

The following sequential operation is performed.

When R020 is changed from OFF to ON, R400 is set to ON and subsequent 9 devices (R401 to R409) are reset to OFF.

When X004 comes ON, R400 is reset to OFF and R401 is set to ON.

When both X005 and R022 are ON, R401 is reset to OFF and R402 is set to ON.

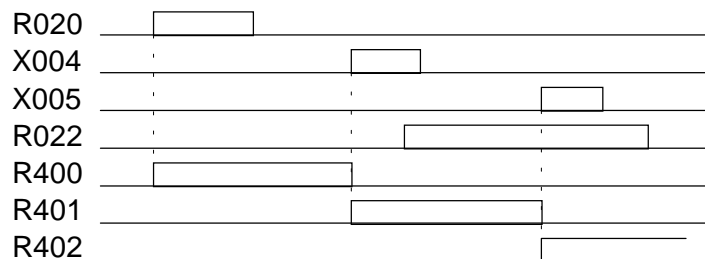

7. Instructions

FUN 146	STOT	Step sequence output
---------	------	----------------------

Expression

Input \neg [STOT A] \neg

Function

When the input is ON, the device A is set to ON and the devices of STIN instructions on the same rung are reset to OFF.

Execution condition

Input	Operation	Output
OFF	No execution	-
ON	Execution	-

Operand

	Name	Device						Register								Constant	Index		
		X	Y	R	S	T	C	XW	YW	RW	SW	T	C	D	I			J	K
A	Step device			√															

Example

See example on STIN (FUN 145) instruction.

Note

- The STIZ, STIN and STOT instructions are used together to configure the step sequence.
- Two or more STOT instructions can be placed on one rung to perform simultaneous sequences.

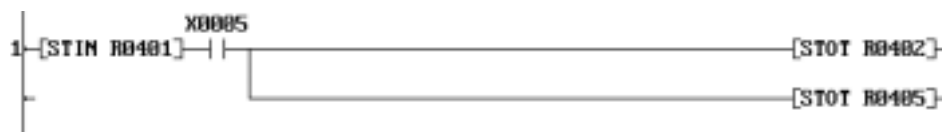

- Two or more STIN instructions can be placed on one rung in parallel or in series to perform loop or convergence of sequences. (Max. 11 STIN instructions on one rung)



- To perform the conditional branch (sequence selection), separate the rungs as follows. This limitation is applied to T1 version 1.00 only.

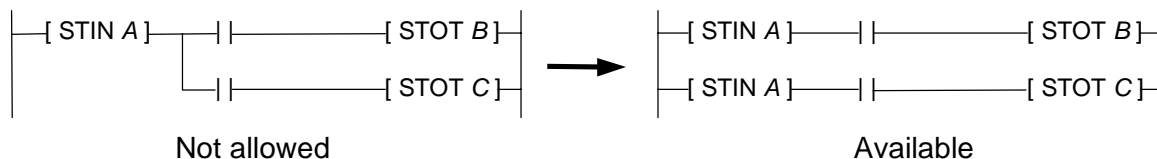

7. Instructions

FUN 147	F/F	Flip-flop
---------	-----	-----------

Expression

Set input	$\left[\begin{array}{c} \text{S} \\ \text{F/F} \\ \text{Q} \end{array} \right]$	Output
Reset input	$\left[\begin{array}{c} \text{R} \\ \text{A} \end{array} \right]$	

Function

When the set input is ON, the device A is set to ON. When the reset input is ON, the device A is reset to OFF. When both the set and reset inputs are OFF, the device A remains the state. If both the set and reset inputs are ON, the device A is reset to OFF. The state of the output is the same as the device A.

Execution condition

Set input	Reset input	Operation	Output
OFF	OFF	No execution (A remains previous state)	Same as A
	ON	Resets A to OFF	
ON	OFF	Sets A to ON	
	ON	Resets A to OFF	

Operand

	Name	Device						Register								Constant	Index		
		X	Y	R	S	T	C	XW	YW	RW	SW	T	C	D	I			J	K
A	Device		√	√	√														

Example

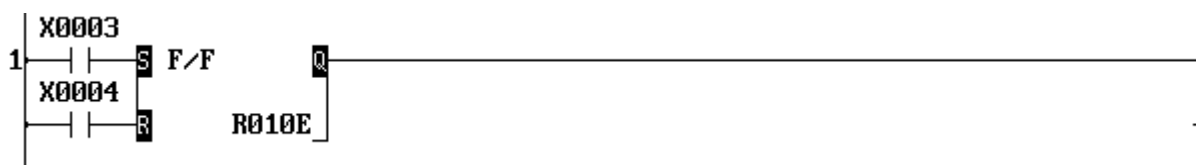

When X003 is ON, R10E is set to ON. When X004 is ON, R10E is reset to OFF. If both are ON, R10E is reset to OFF.

An example timing diagram is shown below.

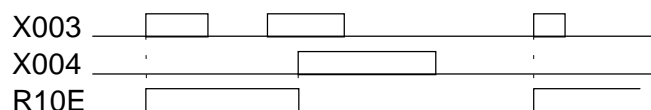

Note

- For the set input, direct linking to a connecting point is not allowed. In this case, insert a dummy contact (always ON = S04F, etc.) just before the input. Refer to Note of Shift register FUN 074.

7. Instructions

FUN 149	U/D	Up-down counter
---------	-----	-----------------

Expression

Direction input	$\left[\begin{array}{c} U \quad U/D \quad Q \\ C \\ E \quad A \end{array} \right] \text{-- Output}$
Count input	
Enable input	

Function

While the enable input is ON, this instruction counts the number of the count input changes from OFF to ON. The count direction (up count or down count) is selected by the state of the direction input. The count value is stored in the counter register A. The count value range is 0 to 65535.

- Up count when the direction input is ON
- Down count when the direction input is OFF

When the enable input is OFF, the counter register A is cleared to 0.

Execution condition

Enable input	Operation	Output
OFF	No operation (A is cleared to 0)	OFF
ON	Count value is not limit value (0 or 65535)	OFF
	Count value is limit value and count input is ON	ON

Operand

	Name	Device						Register								Constant	Index				
		X	Y	R	S	T	C	XW	YW	RW	SW	T	C	D	I			J	K		
A	Count value																				

Example

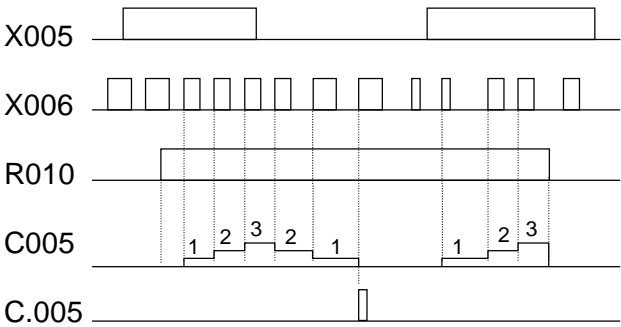

Note

- The transitional contact is required for the count input. Otherwise, counting is executed every scan during X005 is ON in this example.
- For the direction input and the count input, direct linking to a connecting point is not allowed. Refer to Note of Shift register FUN 074.

7. Instructions

FUN 154	CLND	Set calendar
---------	------	--------------

Expression

Input \neg [A CLND] \neg Output

Function

When the input is ON, the built-in clock/calendar is set to the date and time specified by 6 registers starting with A. If an invalid data is contained in the registers, the operation is not executed and the output is turned ON.

Execution condition

Input	Operation	Output
OFF	No operation	OFF
ON	Execution (data is valid)	OFF
	No execution (data is not valid)	ON

Operand

	Name	Device						Register								Constant	Index		
		X	Y	R	S	T.	C.	XW	YW	RW	SW	T	C	D	I			J	K
A	Start of table							√	√	√	√	√	√	√					

Example

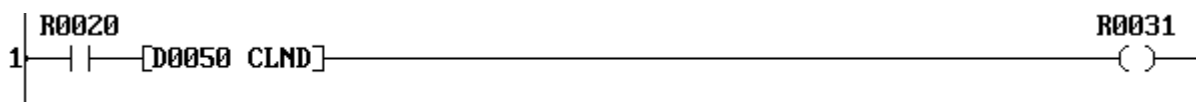

When R020 is ON, the clock/calendar is set according to the data of D0050 to D0055, and the output is OFF (R0031 is OFF).

If D0050 to D0055 contains invalid data, the setting operation is not executed and the output is turned ON (R0031 comes ON).

	F		8	7		0			
D0050	H00					Year	Allowable data range (2-digit BCD) H00 to H99 (1990 - 2089)	→	
D0051	H00					Month			Calendar LSI
D0052	H00					Day			
D0053	H00					Hour			
D0054	H00					Minute			
D0055	H00					Second			
							H01 to H12		
							H01 to H31		
							H00 to H23		
							H00 to H59		
							H00 to H59		

Note

- The day of the week is automatically.

7. Instructions

FUN 155	CLDS	Calendar operation
---------	------	--------------------

Expression

Input \neg [A CLDS B] \neg Output

Function

When the input is ON, this instruction subtracts the date and time stored in 6 registers starting with A from the current date and time, and stores the result in 6 registers starting with B.

If an invalid data is contained in the registers, the operation is not executed and the output is turned ON.

Execution condition

Input	Operation	Output
OFF	No operation	OFF
ON	Execution (data is valid)	OFF
	No execution (data is not valid)	ON

Operand

	Name	Device						Register								Constant	Index	
		X	Y	R	S	T	C	XW	YW	RW	SW	T	C	D	I			J
A	Subtrahend							√	√	√	√	√	√	√				
B	Result								√	√	√	√	√	√				

Example

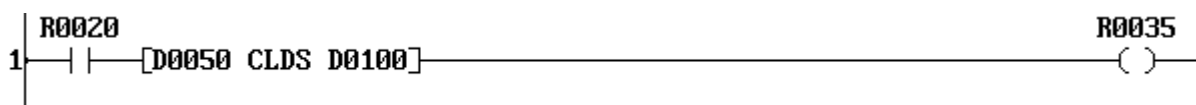

When R020 is ON, the date and time data recorded in D0050 to D0055 are subtracted from the current date and time of clock/calendar, and the result is stored in D0100 to D0105.

In normal operation, the output is OFF (R0035 is OFF). If D0050 to D0055 contains invalid data, the operation is not executed and the output is turned ON (R0035 comes ON).

Current date & time

H0098		D0050	F	H0097	0		D0100	F	H0000	0	(Year)
H0001		D0051		H0010			D0101		H0003		(Month)
H0015	minus	D0052		H0010		→	D0102		H0007		(Day)
H0017		D0053		H0015			D0103		H0001		(Hour)
H0000		D0054		H0030			D0104		H0030		(Minute)
H0000		D0055		H0000			D0105		H0000		(Second)

Note

- Future date and time cannot be used as subtrahend A.
- In the calculation result, it means that 1 year is 365 days and 1 month is 30 days.

7. Instructions

FUN 156	PID3	Pre-derivative real PID
---------	------	-------------------------

Expression

Input \rightarrow [A PID3 B \rightarrow C] \rightarrow Output

Function

Performs PID (Proportional, Integral, Derivative) control which is a fundamental method of feedback control. (Pre-derivative real PID algorithm) This PID3 instruction has the following features.

- For derivative action, incomplete derivative is used to suppress interference of high-frequency noise and to expand the stable application range,
- Controllability and stability are enhanced in case of limit operation for MV, by using digital PID algorithm succeeding to benefits of analog PID.
- Auto, cascade and manual modes are supported in this instruction.
- Digital filter is available for PV.
- Direct / reverse operation is selectable.

Execution condition

Input	Operation	Output
OFF	Initialization	OFF
ON	Execute PID every setting interval	ON when execution

Operand

	Name	Device						Register										Constant	Index	
		X	Y	R	S	T.	C.	XW	YW	RW	SW	T	C	D	I	J	K			
A	Top of input data							√	√	√	√	√	√	√						
B	Top of parameter							√	√	√	√	√	√	√						
C	Top of output data								√	√	√	√	√	√						

Input data			Control parameter			Output data		
A	Process input value	PVC	B	Proportional gain	K_P	C	Manipulation value	MV
A+1	A-mode set value	ASV	B+1	Integral time	T_I	C+1	Last error	e_{n-1}
A+2	C-mode set value	CSV	B+2	Derivative time	T_D	C+2	Last derivative value	D_{n-1}
A+3	M-mode MV input	MMV	B+3	Dead-band	GP	C+3	Last PV	PV_{n-1}
A+4	MV tracking input	TMV	B+4	A-mode initial SV	ISV	C+4	Last SV	SV_{n-1}
A+5	Mode setting	MODE	B+5	Input filter constant	FT	C+5	Integral remainder	I_r
			B+6	ASV differential limit	DSV	C+6	Derivative remainder	D_r
			B+7	MMV differential limit	DMMV	C+7	Internal MV	MV_n
			B+8	Initial status	STS	C+8	Internal counter	C
			B+9	MV upper limit	MH	C+9	Control interval	Δt
			B+10	MV lower limit	ML			
			B+11	MV differential limit	DMV			
			B+12	Control interval setting	n			

A-mode: Auto mode
 C-mode: Cascade mode
 M-mode: Manual mode

7. Instructions

Control block diagram

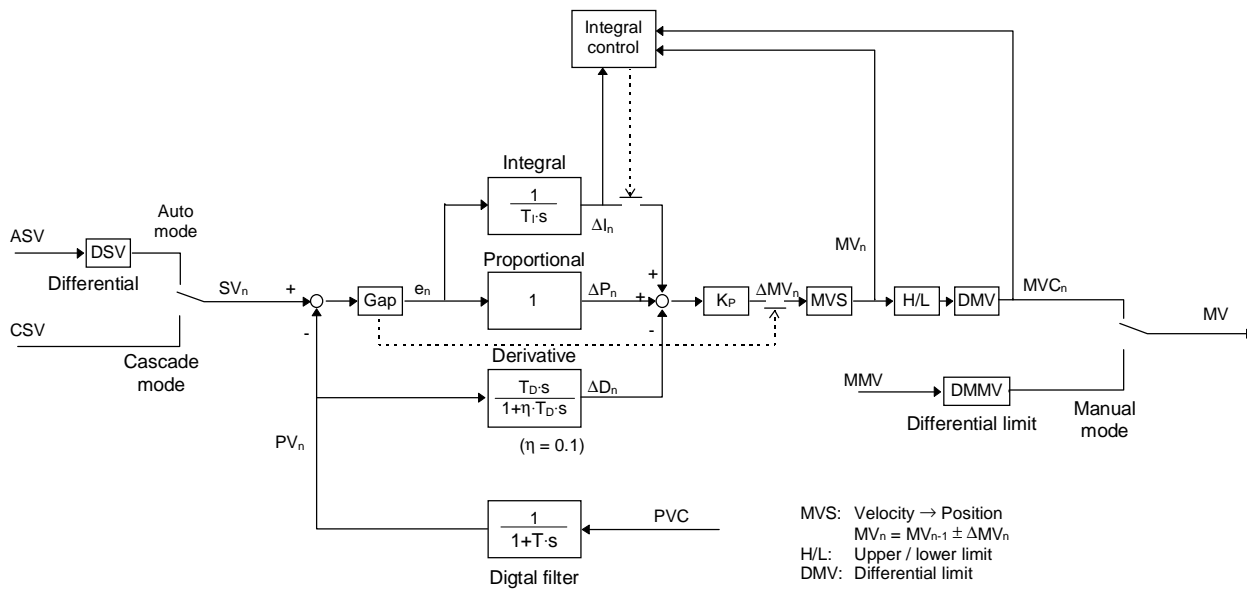

Integral action control:

When MV is limited (H/L, DMV) and the integral value has same sign as limit over, integral action is stopped.

Velocity \rightarrow Position conversion:

In Direct mode, MV increases when PV is increased.

$$\rightarrow MV_n = MV_{n-1} - \Delta MV_n$$

In Reverse mode, MV decreases when PV is increased.

$$\rightarrow MV_n = MV_{n-1} + \Delta MV_n$$

Gap (dead-band) operation:

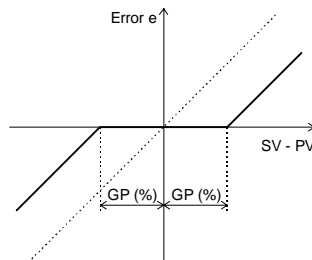

Algorithm

Digital filter:

$$PV_n = (1 - FT) \cdot PVC + FT \cdot PV_{n-1}$$

Here,

$$0.000 \leq FT \leq 0.999$$

7. Instructions

PID algorithm:

$$\Delta MV_n = K_P \cdot (\Delta P_n + \Delta I_n + \Delta D_n)$$

$$MV_n = MV_{n-1} \pm \Delta MV_n$$

Here,

$$\Delta P_n = e_n - e_{n-1}$$

$$e_n = SV_n - PV_n \quad (\text{If } GP \neq 0, \text{ Gap is applied})$$

$$\Delta I_n = \frac{e_n \cdot \Delta t + I_r}{T_I} \quad (\text{If } T_I = 0, \text{ then } \Delta I_n = 0)$$

$$\Delta D_n = \frac{T_D \cdot (PV_{n-1} - PV_n) - \Delta t \cdot D_{n-1} + Dr}{\Delta t + \eta \cdot T_D}$$

$$D_n = D_{n-1} + \Delta D_n$$

$$\eta = 0.1 \quad (\text{Fixed})$$

Parameter details

A	Process input value PVC (0.00 to 100.00 %)	Data range: 0 to 10000
A+1	Auto mode set value ASV (0.00 to 100.00 %)	Data range: 0 to 10000
A+2	Cascade mode set value CSV (0.00 to 100.00 %)	Data range: 0 to 10000
A+3	Manual mode MV MMV (-25.00 to 125.00 %)	Data range: -2500 to 12500
A+4	MV tracking input TMV (-25.00 to 125.00 %)	Data range: -2500 to 12500
A+5	Mode setting MODE	

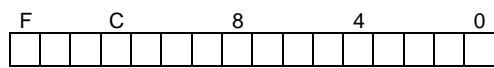

Operation mode
 00 : Manual mode
 01 : Auto mode
 10 : Cascade mode
 11 : (Reserve)

Tracking designation
 0 : No
 1 : Yes

B	Proportional gain K_P (0.00 to 327.67)	Data range: 0 to 32767
B+1	Integral time T_I (0.000 to 32.767 min., $\Delta I_n=0$ if $T_I=0$)	Data range: 0 to 32767
B+2	Derivative time T_D (0.000 to 32.767 min.)	Data range: 0 to 32767
B+3	Gap (dead-band) GP (0.00 to 10.00 %)	Data range: 0 to 1000
B+4	Auto mode initial set value ISV (0.00 to 100.00 %)	Data range: 0 to 10000
B+5	Input filter constant FT (0.000 to 0.999)	Data range: 0 to 999
B+6	ASV differential limit DSV (0.00 to 100.00 %/ Δt)	Data range: 0 to 10000
B+7	MMV differential limit DMMV (0.00 to 100.00 %/ Δt)	Data range: 0 to 10000

7. Instructions

B+8 Initial status STS

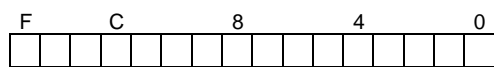

Initial operation mode
 00 : Manual mode
 01 : Auto mode
 10 : Cascade mode
 11 : (Reserve)

Direct / reverse selection
 0 : Direct
 1 : Reverse

<i>B+9</i>	MV upper limit MH (-25.00 to 125.00 %)	Data range: -2500 to 12500
<i>B+10</i>	MV lower limit ML (-25.00 to 125.00 %)	Data range: -2500 to 12500
<i>B+11</i>	MV differential limit DMV (0.00 to 100.00 %/ Δt)	Data range: 0 to 10000
<i>B+12</i>	Control interval setting n (1 to 32767 times)	Data range: 1 to 32767

Executes PID every n scan. Therefore, control interval $\Delta t = n \times$ constant scan interval
 (It is treated as n = 1 when n \leq 0)

<i>C</i>	Manipulation value MV (-25.00 to 125.00 %)	Data range: -2500 to 12500
<i>C+1</i>	Internal work area	
:		
:		
<i>C+9</i>		

Operation

- When the instruction input is OFF:
 Initializes the PID3 instruction.

Operation mode is set as specified by *B+8*.
 Auto mode SV is set as specified by *B+4*.
 Manual mode MV is set as current MV.
 Internal calculation data is initialized.
 MV remains unchanged.

A+5 bit 0, 1 \leftarrow *B+8* bit 0, 1
ASV \leftarrow *ISV*
MMV \leftarrow *MV*

- When the instruction input is ON:
 Executes PID calculation every n scan which is specified by *B+12*. The following operation modes are available according to the setting of *A+5*.

- Auto mode
 This is a normal PID control mode with *ASV* as set value.
 Set value differential limit *DSV*, manipulation value upper/lower limit *MH/ML* and differential limit *DMV* are effective.
 Bump-less changing from auto mode to manual mode is available. (Manual mode manipulation value *MMV* is over-written by current *MV* automatically. *MMV* \leftarrow *MV*)

7. Instructions

- **Manual mode**
 In this mode, the manipulation value MV can be directly controlled by the input value of MMV.
 MV differential limit for manual mode DMMV is effective. MH/ML and DMV are not effective.
 When mode is changed from manual to auto or cascade, the operation is started from the current MV.

- **Cascade mode**
 This is a mode for PID cascade connection. PID is executed with CSV as set value.
 Different from the auto mode, set value differential limit is not effective. Manipulation value upper/lower limit MH/ML and differential limit DMV are effective.
 Bump-less changing from cascade mode to manual mode is available. (Manual mode manipulation value MMV is over-written by current MV automatically. $MMV \leftarrow MV$)
 And, bump-less changing from cascade mode to auto mode is available. (Auto mode set value ASV is over-written by current CSV automatically. $ASV \leftarrow CSV$)

- **MV tracking**
 This function is available in auto and cascade modes. When the tracking designation (A+5 bit 2) is ON, tracking input TMV is directly output as MV.
 Manipulation value upper/lower limit MH/ML is effective, but differential limit DMV is not effective.
 When the tracking designation is changed to OFF, the operation is started from the current MV.

Note

- PID3 instruction is only usable on the main-program.

- PID3 instruction must be used under the constant scan mode. The constant scan interval can be selected in the range of 10 to 200 ms, 10 ms increments.

- The data handled by the PID3 instruction are % units. Therefore, process input value PVC, manipulation value MV, etc., should be converted to % units (scaling), before and/or after the PID3 instruction. For this purpose, the function generator instruction (FUN165 FG) is convenient.

7. Instructions

FUN 160	UL	Upper limit
---------	----	-------------

Expression

Input $\neg[A \text{ UL } B \rightarrow C]$ – Output

Function

When the input is ON, the following operation is executed. (Upper limit for A by B)

If $A \leq B$, then $C = A$.

If $A > B$, then $C = B$.

Execution condition

Input	Operation	Output
OFF	No operation	OFF
ON	Execution: not limited ($A \leq B$)	OFF
	Execution: limited ($A > B$)	ON

Operand

	Name	Device						Register								Constant	Index			
		X	Y	R	S	T	C	XW	YW	RW	SW	T	C	D	I			J	K	
A	Operation data							√	√	√	√	√	√	√	√	√	√	√	√	√
B	Upper limit							√	√	√	√	√	√	√	√	√	√	√	√	√
C	Destination								√	√	√	√	√	√	√	√	√	√	√	√

Example

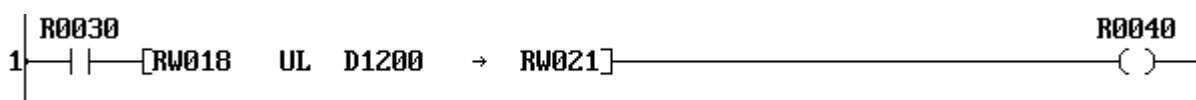

When R030 is ON, the upper limit operation is executed for the data of RW018 by the data of D1200, and the result is stored in RW021.

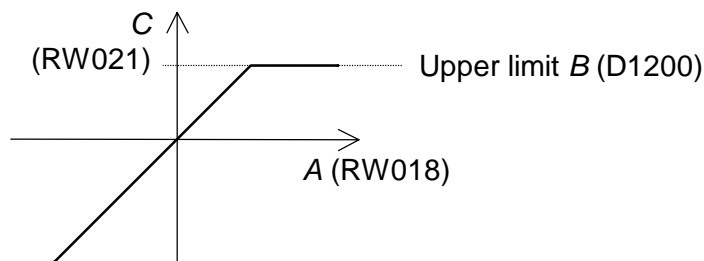

When RW018 is 3000 and D1200 is 4000, 3000 is stored in RW021 and R0040 is OFF.

When RW018 is 4500 and D1200 is 4000, the limit value 4000 is stored in RW021 and R0040 is ON.

Note

- This instruction deals with the data as signed integer (-32768 to 32767).

7. Instructions

FUN 161	LL	Lower limit
---------	----	-------------

Expression

Input $\neg[A \text{ LL } B \rightarrow C]$ – Output

Function

When the input is ON, the following operation is executed. (Lower limit for A by B)

If $A \geq B$, then $C = A$.

If $A < B$, then $C = B$.

Execution condition

Input	Operation	Output
OFF	No operation	OFF
ON	Execution: not limited ($A \geq B$)	OFF
	Execution: limited ($A < B$)	ON

Operand

	Name	Device						Register								Constant	Index		
		X	Y	R	S	T	C	XW	YW	RW	SW	T	C	D	I			J	K
A	Operation data							√	√	√	√	√	√	√	√	√	√	√	√
B	Lower limit							√	√	√	√	√	√	√	√	√	√	√	√
C	Destination								√	√	√	√	√	√	√	√		√	

Example

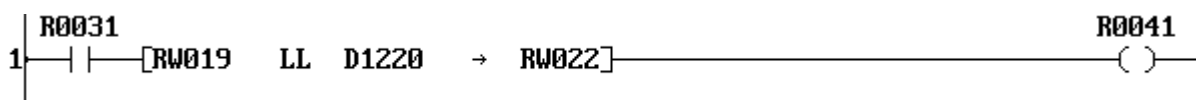

When R031 is ON, the lower limit operation is executed for the data of RW019 by the data of D1220, and the result is stored in RW022.

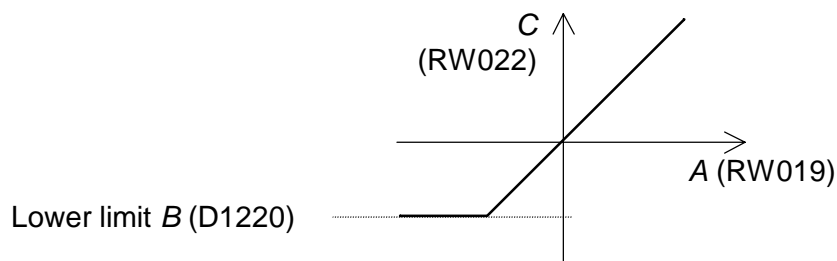

When RW019 is -1000 and D1220 is -1800, -1000 is stored in RW022 and R0041 is OFF.

When RW019 is 800 and D1220 is 1200, the limit value 1200 is stored in RW022 and R0041 is ON.

Note

- This instruction deals with the data as signed integer (-32768 to 32767).

7. Instructions

FUN 162	MAX	Maximum value
---------	-----	---------------

Expression

Input $-[A \text{ MAX } (n) B]$ – Output

Function

When the input is ON, this instruction searches for the maximum value from the table of size n words starting with A , and stores the maximum value in B and the pointer indicating the position of the maximum value in $B+1$. The allowable range of the table size n is 1 to 64.

Execution condition

Input	Operation	Output
OFF	No execution	OFF
ON	Execution	ON

Operand

	Name	Device						Register								Constant	Index			
		X	Y	R	S	T	C	XW	YW	RW	SW	T	C	D	I			J	K	
A	Start of table							√	√	√	√	√	√	√						
n	Table size																		1 - 64	
B	Result								√	√	√	√	√	√	√	√	√			

Example

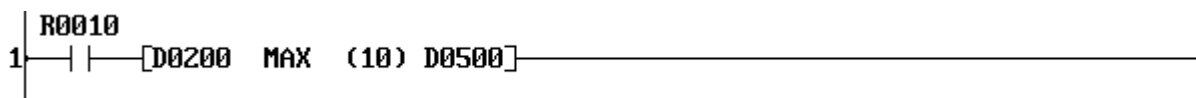

When R010 is ON, the maximum value is found from the register table D0200 to D0209 (10 words), and the maximum value is stored in D0500 and the pointer is stored in D0501.

		Pointer	
D0200	100	0	
D0201	10000	1	
D0202	-1000	2	
D0203	10	3	
D0204	0	4	
D0205	200	5	
D0206	-300	6	
D0207	20000	7	→ D0500
D0208	-30	8	→ D0501
D0209	20	9	

D0500	20000	(Maximum value)
D0501	7	(Pointer)

Note

- This instruction deals with the data as signed integer (-32768 to 32767).
- If there are two or more maximum value in the table, the lowest pointer is stored.
- If Index register K is used as operand B , the pointer data is discarded.

7. Instructions

FUN 163	MIN	Minimum value
---------	-----	---------------

Expression

Input $-\lceil A \text{ MIN } (n) B \rceil$ – Output

Function

When the input is ON, this instruction searches for the minimum value from the table of size n words starting with A , and stores the minimum value in B and the pointer indicating the position of the minimum value in $B+1$. The allowable range of the table size n is 1 to 64.

Execution condition

Input	Operation	Output
OFF	No execution	OFF
ON	Execution	ON

Operand

	Name	Device						Register								Constant	Index		
		X	Y	R	S	T	C	XW	YW	RW	SW	T	C	D	I			J	K
A	Start of table							√	√	√	√	√	√	√					
n	Table size																	1 - 64	
B	Result								√	√	√	√	√	√	√	√			

Example

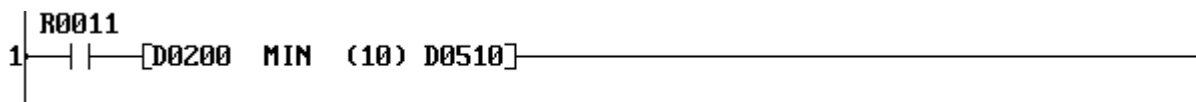

When R011 is ON, the minimum value is found from the register table D0200 to D0209 (10 words), and the minimum value is stored in D0510 and the pointer is stored in D0511.

		Pointer				
D0200	100	0				
D0201	10000	1				
D0202	-1000	2			-1000	(Minimum value)
D0203	10	3			2	(Pointer)
D0204	0	4				
D0205	200	5				
D0206	-300	6				
D0207	20000	7				
D0208	-30	8				
D0209	20	9				

Note

- This instruction deals with the data as signed integer (-32768 to 32767).
- If there are two or more minimum value in the table, the lowest pointer is stored.
- If Index register K is used as operand B , the pointer data is discarded.

7. Instructions

FUN 164	AVE	Average value
---------	-----	---------------

Expression

Input $-\{A \text{ AVE } (n) B\}$ – Output

Function

When the input is ON, this instruction calculates the average value of the data stored in the n registers starting with A , and stores the average value in B . The allowable range of the table size n is 1 to 64.

Execution condition

Input	Operation	Output
OFF	No execution	OFF
ON	Execution	ON

Operand

	Name	Device						Register										Constant	Index		
		X	Y	R	S	T	C	XW	YW	RW	SW	T	C	D	I	J	K				
A	Start of table							√	√	√	√	√	√	√							
n	Table size																			1 - 64	
B	Result								√	√	√	√	√	√	√	√	√	√	√		

Example



When R012 is ON, the average value of the data stored in the register table D0200 to D0209 (10 words), and the average value is stored in D0520.

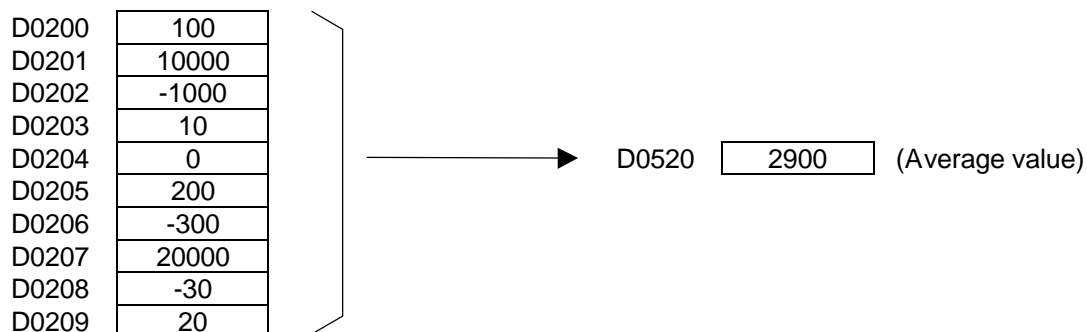

7. Instructions

FUN 165	FG	Function generator
---------	----	--------------------

Expression

Input $\neg[A \text{ FG } (n) B \rightarrow C]$ – Output

Function

When the input is ON, this instruction finds the function value $f(x)$ for A as x , and stores it in C . The function $f(x)$ is defined by the parameters stored in $2 \times n$ registers starting with B .

Execution condition

Input	Operation	Output
OFF	No execution	OFF
ON	Execution	ON

Operand

	Name	Device						Register										Constant	Index
		X	Y	R	S	T	C	XW	YW	RW	SW	T	C	D	I	J	K		
A	Input value x							√	√	√	√	√	√	√	√	√	√	√	
n	Parameter size																	1 - 32	
B	Start of parameters							√	√	√	√	√	√						
C	Function value $f(x)$								√	√	√	√	√	√	√	√			

Example

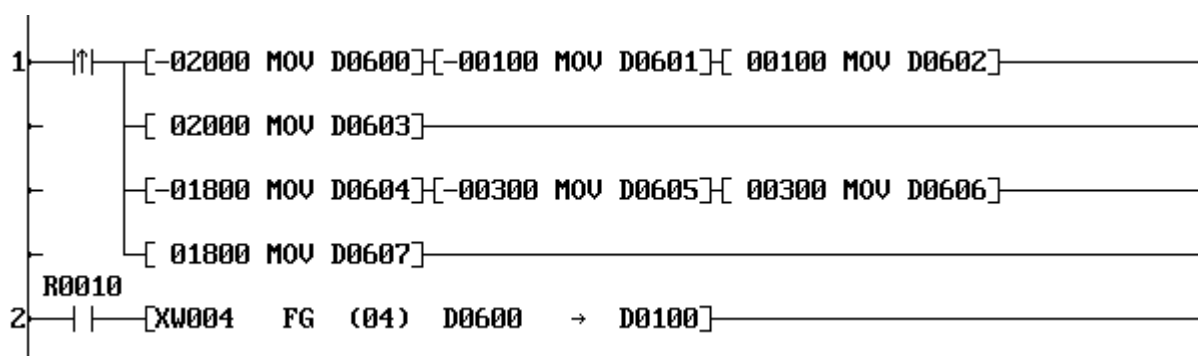

When R010 is ON, the FG instruction finds the function value $f(x)$ for $x = XW004$, and stores the result in D0100.

The function $f(x)$ is defined by $2 \times 4 = 8$ parameters stored in D0600 to D0607. In this example, these parameters are set at the first scan.

7. Instructions

Parameter table

4 registers for x parameters and subsequent 4 registers for corresponding $f(x)$ parameters

D0600	-2000	x_1
D0601	-100	x_2
D0602	100	x_3
D0603	2000	x_4
D0604	-1800	y_1
D0605	-300	y_2
D0606	300	y_3
D0607	1800	y_4

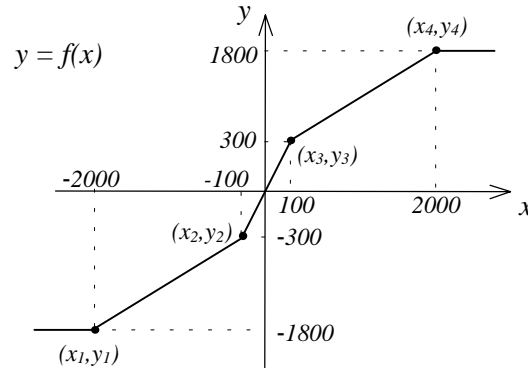

The FG instruction interpolates $f(x)$ value for x based on the n parameters of (x_i, y_i) . For example, if XW04 is 1500 ($x = 1500$), the result 1405 ($f(x) = 1405$) is stored in D0100.

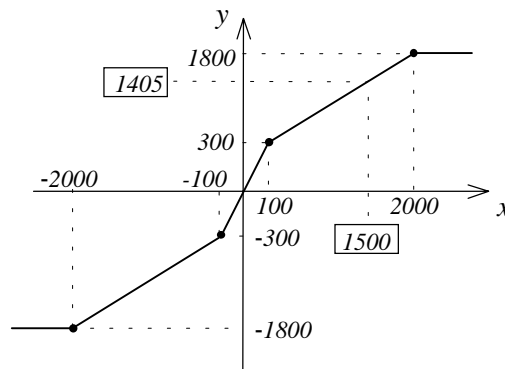

Note

- The order of the x parameters should be $x_1 \leq x_2 \leq \dots \leq x_i \leq \dots \leq x_n$. In the above example, the data of D0600 to D0603 should be $D0600 \leq D0601 \leq D0602 \leq D0603$.
- If x is smaller than x_1 , y_1 is given as $f(x)$. In this example, D0604 data (-1800) is stored in D0100 if XW04 is smaller than D0600 (-2000).
- If x is greater than x_n , y_n is given as $f(x)$. In this example, D0607 data (1800) is stored in D0100 if XW04 is greater than D0603 (2000).
- The valid data range is -32768 to 32767.

7. Instructions

FUN 180	ABS	Absolute value
---------	-----	----------------

Expression

Input $\neg[A \text{ ABS } B]$ – Output

Function

When the input is ON, this instruction finds the absolute value of operand *A*, and stores it in *B*.

Execution condition

Input	Operation	Output
OFF	No execution	OFF
ON	Execution	ON

Operand

	Name	Device						Register										Constant	Index
		X	Y	R	S	T	C	XW	YW	RW	SW	T	C	D	I	J	K		
<i>A</i>	Source							√	√	√	√	√	√	√	√	√	√	√	
<i>B</i>	Destination								√	√	√	√	√	√	√	√	√		

Example

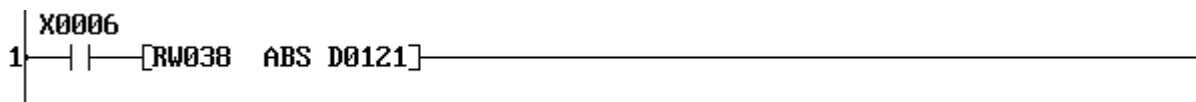

When X006 is ON, the absolute value of RW38 is stored in D0121.
For example, if RW38 is -12000, the absolute value 12000 is stored in D0121.

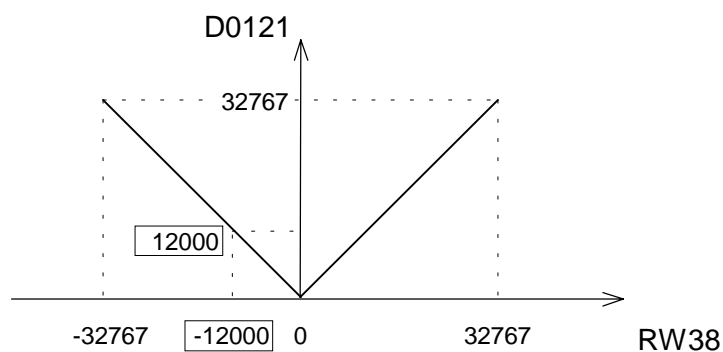

Note

- The data range of *A* is -32768 to 32767. If the data of *A* is -32768, 32767 is stored in *B*.

7. Instructions

FUN 182	NEG	2's complement
---------	-----	----------------

Expression

Input $\neg[A \text{ NEG } B]$ – Output

Function

When the input is ON, this instruction finds the 2's complement value of *A*, and stores it in *B*.

Execution condition

Input	Operation	Output
OFF	No execution	OFF
ON	Execution	ON

Operand

	Name	Device						Register										Constant	Index		
		X	Y	R	S	T	C	XW	YW	RW	SW	T	C	D	I	J	K				
<i>A</i>	Source							√	√	√	√	√	√	√	√	√	√	√	√	√	
<i>B</i>	Destination								√	√	√	√	√	√	√	√	√	√	√		

Example



When X007 is ON, the 2's complement value (sign inverted data) of RW39 is stored in D0122. For example, if RW38 is 4660, the 2's complement value -4660 is stored in D0122.

2's complement data is calculated as follows.

RW39	F E D C B A 9 8 7 6 5 4 3 2 1 0	(4660)																
	<table border="1" style="border-collapse: collapse; width: 100%;"> <tr><td>0</td><td>0</td><td>0</td><td>1</td><td>0</td><td>0</td><td>1</td><td>0</td><td>0</td><td>0</td><td>1</td><td>1</td><td>0</td><td>1</td><td>0</td><td>0</td></tr> </table>	0	0	0	1	0	0	1	0	0	0	1	1	0	1	0	0	
0	0	0	1	0	0	1	0	0	0	1	1	0	1	0	0			
	↓ Bit inverse																	
	<table border="1" style="border-collapse: collapse; width: 100%;"> <tr><td>1</td><td>1</td><td>1</td><td>0</td><td>1</td><td>1</td><td>0</td><td>1</td><td>1</td><td>1</td><td>0</td><td>0</td><td>1</td><td>0</td><td>1</td><td>1</td></tr> </table>	1	1	1	0	1	1	0	1	1	1	0	0	1	0	1	1	(-4661)
1	1	1	0	1	1	0	1	1	1	0	0	1	0	1	1			
	↓ + 1																	
D0122	<table border="1" style="border-collapse: collapse; width: 100%;"> <tr><td>1</td><td>1</td><td>1</td><td>0</td><td>1</td><td>1</td><td>0</td><td>1</td><td>1</td><td>1</td><td>0</td><td>0</td><td>1</td><td>1</td><td>0</td><td>0</td></tr> </table>	1	1	1	0	1	1	0	1	1	1	0	0	1	1	0	0	(-4660)
1	1	1	0	1	1	0	1	1	1	0	0	1	1	0	0			

Note

- The data range of *A* is -32768 to 32767. If the data of *A* is -32768, the same data -32768 is stored in *B*.

7. Instructions

FUN 183	DNEG	Double-word 2's complement
---------	------	----------------------------

Expression

Input $-\lceil A+1 \cdot A \text{ DNEG } B+1 \cdot B \rceil$ – Output

Function

When the input is ON, this instruction finds the 2's complement value of double-word data $A+1 \cdot A$, and stores it in $B+1 \cdot B$.

Execution condition

Input	Operation	Output
OFF	No execution	OFF
ON	Execution	ON

Operand

	Name	Device						Register								Constant	Index		
		X	Y	R	S	T	C	XW	YW	RW	SW	T	C	D	I			J	K
A	Source							√	√	√	√	√	√	√				√	
B	Destination								√	√	√	√	√	√					

Example

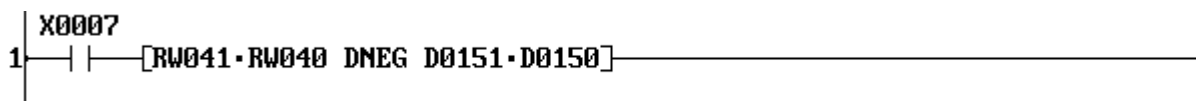

When X007 is ON, the 2's complement value (sign inverted data) of double-word register RW41·RW40 is stored in double-word register D0151·D0150.

For example, if RW41·RW40 is -1234567890, the 2's complement value 1234567890 is stored in D0151·D0150.

Note

- The data range of $A+1 \cdot A$ is -2147483648 to 2147483647. If the data of $A+1 \cdot A$ is -2147483648, the same data -2147483648 is stored in $B+1 \cdot B$.

7. Instructions

FUN 185	7SEG	7 segment decode
---------	------	------------------

Expression

Input $\neg[A \text{ 7SEG } B]$ – Output

Function

When the input is ON, this instruction converts the lower 4 bits data of *A* into the 7 segment code, and stores it in *B*. The 7 segment code is normally used for a numeric display LED.

Execution condition

Input	Operation	Output
OFF	No execution	OFF
ON	Execution	ON

Operand

	Name	Device						Register										Constant	Index
		X	Y	R	S	T	C	XW	YW	RW	SW	T	C	D	I	J	K		
<i>A</i>	Source							√	√	√	√	√	√	√	√	√	√		
<i>B</i>	Destination								√	√	√	√	√	√	√	√	√		

Example

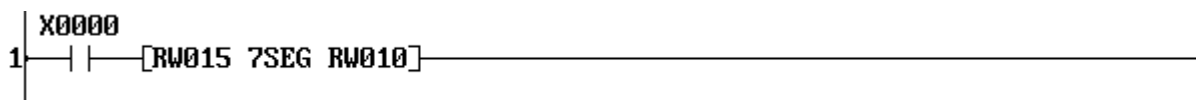

When X000 is ON, the lower 4 bits data of RW15 is converted into the 7 segment code, and the result is stored in lower 8 bits of RW10. 0 is stored in upper 8 bits of RW10.

For example, if RW15 is H0009, the corresponding 7 segment code H006F is stored in RW10.

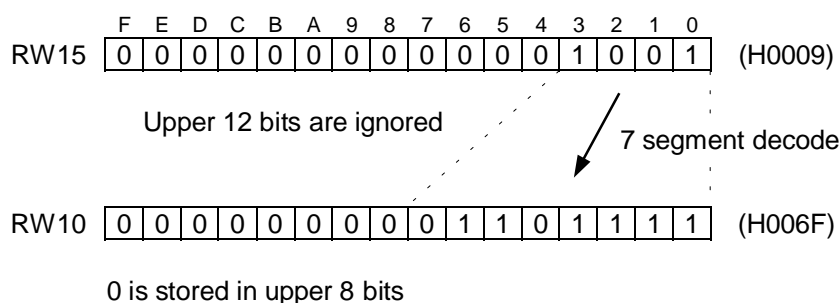

The 7 segment code conversion table is shown on the next page.

7. Instructions

Operand A (lower 4 bits)		7 segment LED composition	Operand B (lower 8 bits)								Display
Hex	Binary		B7	B6	B5	B4	B3	B2	B1	B0	
0	0000		0	0	1	1	1	1	1	1	0
1	0001		0	0	0	0	0	1	1	0	1
2	0010		0	1	0	1	1	0	1	1	2
3	0011		0	1	0	0	1	1	1	1	3
4	0100		0	1	1	0	0	1	1	0	4
5	0101		0	1	1	0	1	1	0	1	5
6	0110		0	1	1	1	1	1	0	1	6
7	0111		0	0	1	0	0	1	1	1	7
8	1000		0	1	1	1	1	1	1	1	8
9	1001		0	1	1	0	1	1	1	1	9
A	1010		0	1	1	1	0	1	1	1	A
B	1011		0	1	1	1	1	1	0	0	b
C	1100		0	0	1	1	1	0	0	1	c
D	1101		0	1	0	1	1	1	1	0	d
E	1110		0	1	1	1	1	0	0	1	e
F	1111		0	1	1	1	0	0	0	1	f

7. Instructions

FUN 186	ASC	ASCII conversion
---------	-----	------------------

Expression

Input $-\{A \text{ ASC } B\}$ – Output

Function

When the input is ON, this instruction converts the alphanumeric characters into the ASCII codes, and stores them in the register table starting with *B*. (16 characters maximum)

Execution condition

Input	Operation	Output
OFF	No execution	OFF
ON	Execution	ON

Operand

	Name	Device						Register								Constant	Index		
		X	Y	R	S	T	C	XW	YW	RW	SW	T	C	D	I			J	K
<i>A</i>	Characters																	√	
<i>B</i>	Start of destination								√	√	√	√	√	√					

Example



When R030 is ON, the characters 'ABCDEFGHIJKLMN' is converted into the ASCII codes, and the result is stored in 8 registers starting with lower 8 bits (byte) of D0200 (D0200 to D0207).

	High	Low
	F 8 7	0
D0200	H42 (B)	H41 (A)
D0201	H44 (D)	H43 (C)
D0202	H46 (F)	H45 (E)
D0203	H48 (H)	H47 (G)
D0204	H4A (J)	H49 (I)
D0205	H4C (L)	H4B (K)
D0206	H4E (N)	H4D (M)
D0207		

← Previous data is remained

Note

- Only the number of bytes converted are stored. The rest are not changed. In the above example, 14 characters are converted into 14 bytes of ASCII code, and these ASCII codes are stored in 7 registers (D0200 to D0206). The data of D0207 remains unchanged.

7. Instructions

FUN 188	BIN	Binary conversion
---------	-----	-------------------

Expression

Input --[A BIN B] – Output

Function

When the input is ON, this instruction converts the 4 digits of BCD data of *A* into binary, and stores in *B*. If any digit of *A* contains non-BCD code (other than H0 through H9), the conversion is not executed and the instruction error flag (ERF = S051) is set to ON.

Execution condition

Input	Operation	Output	ERF
OFF	No execution	OFF	–
ON	Normal execution	ON	–
	BCD data error	OFF	Set

Operand

	Name	Device						Register								Constant	Index		
		X	Y	R	S	T	C	XW	YW	RW	SW	T	C	D	I			J	K
A	Source (BCD)							√	√	√	√	√	√	√	√	√	√	H0000 - H9999	
B	Destination (Binary)								√	√	√	√	√	√	√	√	√		

Example

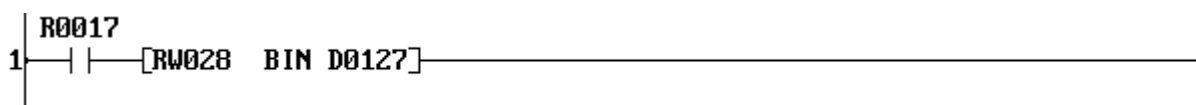

When R017 is ON, the BCD data of RW28 is converted into binary data, and the result is stored in D0127.

For example, if RW28 is H1234, the binary data 1234 is stored in D0127.

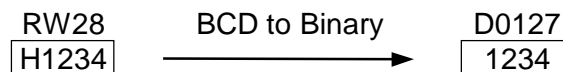

Note

- If any digit of operand *A* contains non-BCD data, e.g. H13A6, the conversion is not executed and the instruction error flag (ERF = S051) is set to ON.

7. Instructions

FUN 190	BCD	BCD conversion
---------	-----	----------------

Expression

Input $-\{A \text{ BCD } B\}$ – Output

Function

When the input is ON, this instruction converts the binary data of *A* into BCD, and stores in *B*. If the data of *A* is not in the range of 0 to 9999, the conversion is not executed and the instruction error flag (ERF = S051) is set to ON.

Execution condition

Input	Operation	Output	ERF
OFF	No execution	OFF	–
ON	Normal execution	ON	–
	Binary data error	OFF	Set

Operand

	Name	Device						Register								Constant	Index		
		X	Y	R	S	T	C	XW	YW	RW	SW	T	C	D	I			J	K
<i>A</i>	Source (Binary)							√	√	√	√	√	√	√	√	√	√	0 - 9999	
<i>B</i>	Destination (BCD)								√	√	√	√	√	√	√	√	√		

Example

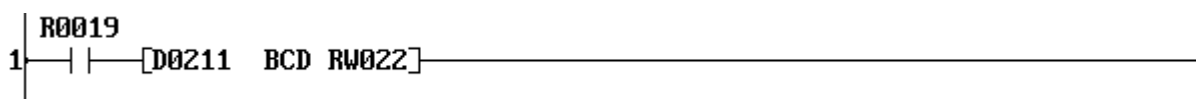

When R019 is ON, the data of D0211 is converted into 4-digit BCD, and the result is stored in RW22.

For example, if D0211 is 5432, the BCD data H5432 is stored in RW22.

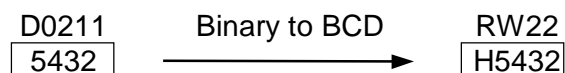

Note

- If the data of *A* is smaller than 0 or greater than 9999, the conversion is not executed and the instruction error flag (ERF = S051) is set to ON.

7. Instructions

FUN 235	I/O	Direct I/O
---------	-----	------------

Expression

Input $-\lceil$ I/O (n) A \rceil - Output

Function

When the input is ON, this instruction immediately updates the external input (XW) and output (YW) registers which are in the range of n registers starting with A .

- For XW register ... reads the data from corresponding input circuit
- For YW register ... writes the data into corresponding output circuit

Execution condition

Input	Operation	Output
OFF	No execution	OFF
ON	Execution	ON

Operand

	Name	Device						Register								Constant	Index		
		X	Y	R	S	T	C	XW	YW	RW	SW	T	C	D	I			J	K
n	Register size																	1 - 32	
A	Start of registers							√	√										

Example

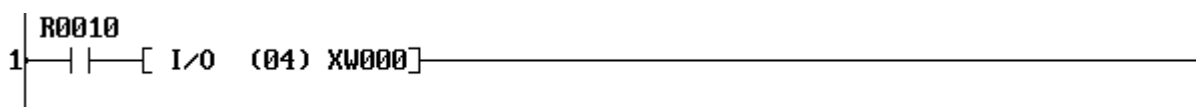

When R010 is ON, the 4 registers starting with XW00 (XW00 to YW03) are updated immediately.

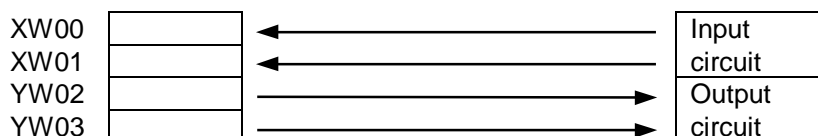

7. Instructions

Note

- In the T1-16S, the following register/device range is only effective for this Direct I/O instruction.

Input on basic unit	Output on basic unit	I/O module
X000 - X007	Y020 - Y027	Not effective

- The Direct I/O instruction can be programmed in the main program and in the interrupt program. If this instruction is programmed in both, the instruction in the main program should be executed in interrupt disable state. Refer to EI (FUN 140) and DI (FUN 141) instructions.

7. Instructions

FUN 236	XFER	Expanded data transfer
---------	------	------------------------

Expression

Input \rightarrow [A XFER B \rightarrow C] \rightarrow Output

Function

When the input is ON, data block transfer is performed between the source which is indirectly designated by *A* and *A+1* and the destination which is indirectly designated by *C* and *C+1*. The transfer size (number of words) is designated by *B*.

The transfer size is 1 to 256 words. (except for writing into EEPROM)

Data transfer between the following objects are available.

- CPU register (RW or D) \leftrightarrow EEPROM (D register)
- CPU register (RW or D) \leftrightarrow T1S RS-485 port (T1S only)

Execution condition

Input	Operation	Output	ERF
OFF	No execution	OFF	–
ON	Normal execution	ON	–
	When error is occurred (see Note)	ON	Set

Operand

	Name	Device						Register								Constant	Index	
		X	Y	R	S	T	C	XW	YW	RW	SW	T	C	D	I			J
<i>A</i>	Source parameter							√	√	√	√	√	√	√				
<i>B</i>	Transfer size							√	√	√	√	√	√	√				
<i>C</i>	Destination parameter								√	√	√	√	√	√				

Parameters

<p style="text-align: center;">Source parameter</p> <table border="1" style="width: 100%; border-collapse: collapse;"> <tr> <td style="width: 10%;"><i>A</i></td> <td style="width: 80%; text-align: center;">Type</td> </tr> <tr> <td><i>A+1</i></td> <td style="text-align: center;">Leading address</td> </tr> </table>	<i>A</i>	Type	<i>A+1</i>	Leading address	<p style="text-align: center;">Transfer size and status</p> <table border="1" style="width: 100%; border-collapse: collapse;"> <tr> <td style="width: 10%;"><i>B</i></td> <td style="width: 80%; text-align: center;">Transfer size</td> </tr> <tr> <td><i>B+1</i></td> <td style="text-align: center;">Status flag for RS-485 port</td> </tr> <tr> <td><i>B+2</i></td> <td style="text-align: center;">(max. 2 words)</td> </tr> </table>	<i>B</i>	Transfer size	<i>B+1</i>	Status flag for RS-485 port	<i>B+2</i>	(max. 2 words)	<p style="text-align: center;">Destination parameter</p> <table border="1" style="width: 100%; border-collapse: collapse;"> <tr> <td style="width: 10%;"><i>C</i></td> <td style="width: 80%; text-align: center;">Type</td> </tr> <tr> <td><i>C+1</i></td> <td style="text-align: center;">Leading address</td> </tr> </table>	<i>C</i>	Type	<i>C+1</i>	Leading address
<i>A</i>	Type															
<i>A+1</i>	Leading address															
<i>B</i>	Transfer size															
<i>B+1</i>	Status flag for RS-485 port															
<i>B+2</i>	(max. 2 words)															
<i>C</i>	Type															
<i>C+1</i>	Leading address															

Register type	Type code	Leading address	Transfer size
RW register (RAM)	H0003	0 to 255	1 to 256
D register (RAM)	H0004	0 to 4095	1 to 256
D register (EEPROM)	H0020	0 to 2047	1 to 32 (if destination) 1 to 256 (if source)
T1S RS-485 port	H0030	0 (fixed)	1 to 256

7. Instructions

CPU register ↔ built-in EEPROM

In the EEPROM, the D registers are divided into pages as follows.

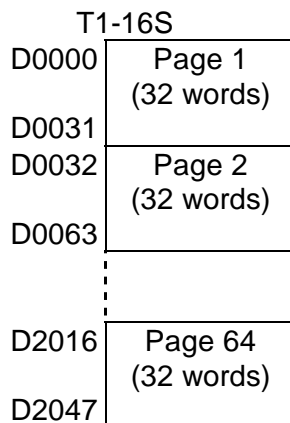

- Writing data into the EEPROM is available within one page at a time. (max. 32 words)
- For data reading from the EEPROM, there is no need to consider the pages.

Example

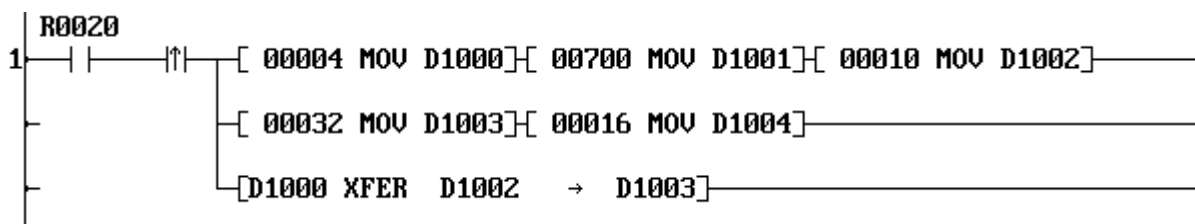

When R020 is changed from OFF to ON, 10 words of RAM data (D0700 to D0709) are written into the EEPROM (D0016 to D0025).

D1000 (H0004) and D1001 (700) indicate the leading register of the source table (D0700 in RAM). D1002 (10) indicates the transfer size (10 words = 10 registers). D1003 (H0020 = 32) and D1004 (16) indicate the leading register of the destination table (D0016 in EEPROM).

Note

- The XFER instruction is not executed as error in the following cases. In these cases, the instruction error flag (ERF = S051) is set to ON. If the ERF is set to ON once, it remains ON until resetting to OFF by user program.
 - (1) When the number of words transferred exceeds limit.
 - (2) When the source/destination table of transfer is out of the valid range.
 - (3) When the transfer combination is invalid.
- The EEPROM has a life limit for data writing into an address. It is 100,000 times. Pay attention not to exceed the limit. (EEPROM alarm flag = S007 is not updated by this instruction)
- Once data writing into the EEPROM is executed, EEPROM access (read/write) is prohibited for the duration of 10 ms. Therefore, minimum 10 ms interval is necessary for data writing.
- The XFER instruction can be programmed in the main program and in the interrupt program. If this instruction is programmed in both, the instruction in the main program should be executed in interrupt disable state. Refer to EI (FUN 140) and DI (FUN 141) instructions.

7. Instructions

CPU register ↔ T1S RS-485 port

<Receiving>

When the instruction input is ON, one set of message (from start character to the trailing code) which is received by the RS-485 port is read from the receive buffer, and stored in the CPU registers. The transfer size is fixed to 256 words. The execution status and the message length (in bytes) are stored in the status flag.

The instruction input must be kept ON until the receiving operation is complete.

Example

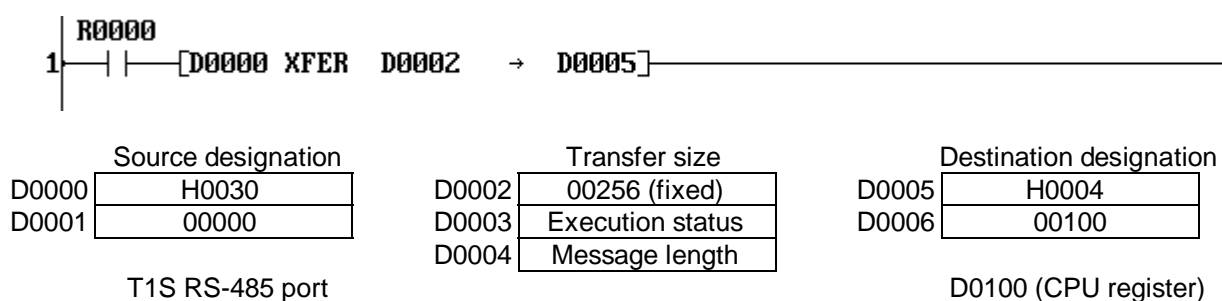

When R0000 is ON, one set of received message is read and stored in D0100 and after.

Execution status: H0000 ... Normal complete
 H0001 ... Communication error (parity error, framing error)
 H0002 ... Message length over (more than 512 bytes)
 H0003 ... Receive buffer over flow
 H0004 ... Receive time-out (from start character to the trailing code)

Baudrate	Time-out setting
300, 600, 1200 bps	30 seconds
2400 bps	15 seconds
4800 bps	7 seconds
9600 bps	3 seconds
19200 bps	1.5 seconds

Message length: 0 No receive message
 1 to 512 ... Message length in bytes

Note

- The XFER instruction is not executed as error in the following cases. In these cases, the instruction error flag (ERF = S051) is set to ON. If the ERF is set to ON once, it remains ON until resetting to OFF by user program.
 - (1) The leading address for the RS-485 port designation is other than 0.
 - (2) Transfer size is other than 256.
 - (3) Mode setting of the RS-485 port is not the free ASCII mode.
 - (4) This instruction is programmed in the sub-program #1.

7. Instructions

<Transmitting>

When the instruction input is ON, one set of message which is stored in the source table (from start character to the trailing code) is transmitted through the RS-485 port. The execution status is stored in the status flag.

The instruction input must be kept ON until the transmitting operation is complete.

Example

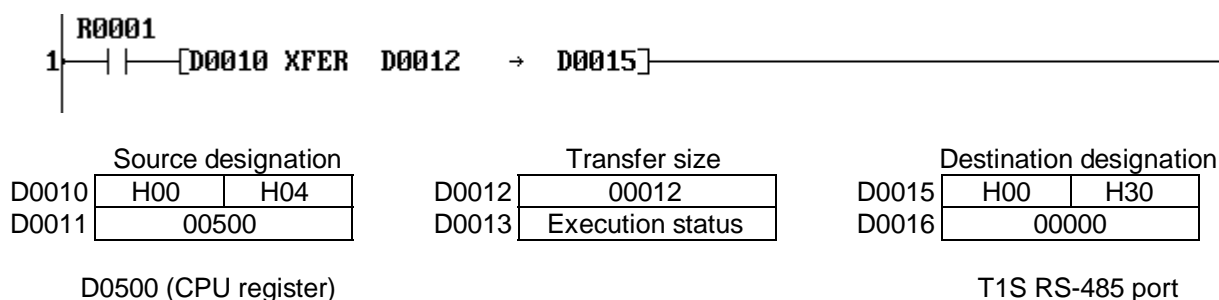

When R0001 is ON, one set of message (ended by the trailing code) stored in the range of D0500 to D0511 (12 words) is transmitted through the RS-485 port.

Execution status:

- H0000 ... Normal complete
- H0001 ... During transmitting the message
- H0002 ... Communication busy
- H0003 ... During the reset operation
- H0004 ... Send time-out (from start character to the trailing code)
- H0005 ... Send message length error (no trailing code in the source table)

Baudrate	Time-out setting
300, 600, 1200 bps	30 seconds
2400 bps	15 seconds
4800 bps	7 seconds
9600 bps	3 seconds
19200 bps	1.5 seconds

Note

- The XFER instruction is not executed as error in the following cases. In these cases, the instruction error flag (ERF = S051) is set to ON. If the ERF is set to ON once, it remains ON until resetting to OFF by user program.
 - (1) The leading address for the RS-485 port designation is other than 0.
 - (2) Transfer size is out of the range of 1 to 256.
 - (3) Mode setting of the RS-485 port is not the free ASCII mode.
 - (4) This instruction is programmed in the sub-program #1.

7. Instructions

FUN 236	XFER	Expanded data transfer (Inverter connection mode)
---------	------	---

Expression

Input \rightarrow [A XFER B \rightarrow C] \rightarrow Output

Function

This function is provided to control Toshiba Inverters VF-A7/G7/S9 connected on the RS-485 line. When the RS-485 port operation mode is set to the Inverter mode (SW56 = 3), the T1-16S can perform the following functions for up to 63 Inverters.

- (1) Cyclically scans the Inverters and sends/receives the following data to/from each Inverter.
 - Send to Inverter: Frequency reference write and Operation command write (Run, Stop, etc.)
 - Receive from Inverter: Operating frequency monitor and Output terminal status monitor
- (2) Cyclically scans the Inverters and receives the following data from each Inverter.
 - Receive from Inverter: Operating frequency monitor and Output terminal status monitor
- (3) Sends a specified Read command to a specified Inverter and stores the response data.
- (4) Sends a specified Write command with the command data to a specified Inverter.
- (5) Sends a specified Write command with the command data to all the connected inverters as broadcast.

Execution condition

Input	Operation	Output	ERF
OFF	No execution	OFF	–
ON	Normal execution	ON	–
	When error is occurred (see Note)	ON	Set

Operand

	Name	Device						Register								Constant	Index
		X	Y	R	S	T	C	XW	YW	RW	SW	T	C	D	I		
A	Data table							√	√	√	√	√	√	√			
B	Inverter No.							√	√	√	√	√	√	√			
C	RS-485 port								√	√	√	√	√	√			

Parameters

	Data table designation		Parameter and status		RS-485 port designation	
A	Register type code	B	Inverter number	C	Fixed to H0030	
A+1	Leading address	B+1	Operation mode	C+1	Fixed to 0	
		B+2	Execution status			
		B+3	Communication error code			
		B+4	Inverter communication status map (each bit shows each Inverter status)			
		B+5				
		B+6				
		B+7				

Data table designation (A, A+1):

Register	Type code (A)	Leading address (A+1)
RW register	H0003	0 to 255
D register	H0004	0 to 4095

7. Instructions

Operation mode designation ($B+1$):

$B+1$	Operation mode	Description
0	Data exchange mode (Mode 0)	Cyclically scans the connected Inverters (Control & Monitor) (Inverter command: P+FA01&FA00 and R+FD00&FE07)
1	Monitor mode (Mode 1)	Cyclically scans the connected Inverters (Monitor only) (Inverter command: R+FD00&FE07)
2	Read command mode (Mode 2)	Sends a read command to a specified Inverter (Inverter command: R+ User designation)
3	Write command mode (Mode 3)	Sends a write command to a specified Inverter (Inverter command: P+ User designation)
4	Broadcast mode (Mode 4)	Sends a write command to all the connected Inverters as broadcast (Inverter command: P+ User designation)

Inverter number (B):

For the operation mode 0 and 1:

It specifies the maximum Inverter number. For example, if it is 5, the T1-16S scans from #0 through #5 Inverters and repeats. Setting range is 0 to 63.

For the operation mode 2 and 3:

It specifies the target Inverter number for sending commands. Setting range is 0 to 63.

For the operation mode 4:

This setting is ignored. The broadcast address (HFF) is used as Inverter number.

Execution status ($B+2$):

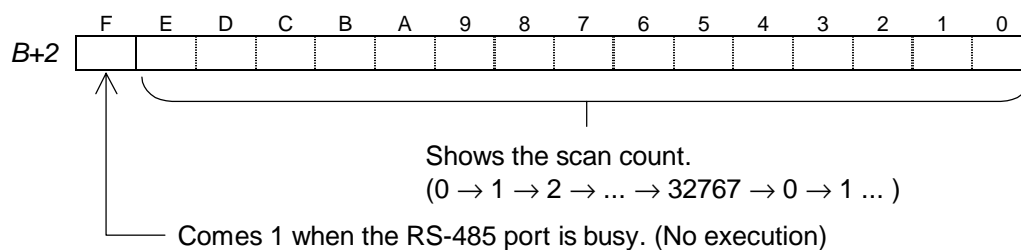

Communication error code ($B+3$):

The communication error code responded from the Inverter is shown here. If 2 or more Inverters are error, the smallest Inverter number's error is stored. Refer to Inverter's manual for the error code.

$B+3$	Meaning
0	No error (Normal)
	Response time-out (No answer)
Others	Inverter error response (Refer to Inverter's manual)

Inverter communication status map ($B+4$ to $B+7$):

This 4-word table shows the communication status map of each Inverter. (1: Normal / 0: Error or No answer)

	F	E	D	C	B	A	9	8	7	6	5	4	3	2	1	0
$B+4$	15	14	13	12	11	10	9	8	7	6	5	4	3	2	1	0
$B+5$	31	30	29	28	27	26	25	24	23	22	21	20	19	18	17	16
$B+6$	47	46	45	44	43	42	41	40	39	38	37	36	35	34	33	32
$B+7$	63	62	61	60	59	58	57	56	55	54	53	52	51	50	49	48

7. Instructions

< Data exchange mode (Mode 0) >

When the instruction input comes ON with the operand $B+1$ is 0, the Data exchange mode (mode 0) is selected. In this mode, the T1-16S sends the following commands to the Inverters starting from #0 through the Inverter number specified by the operand B , and repeats.

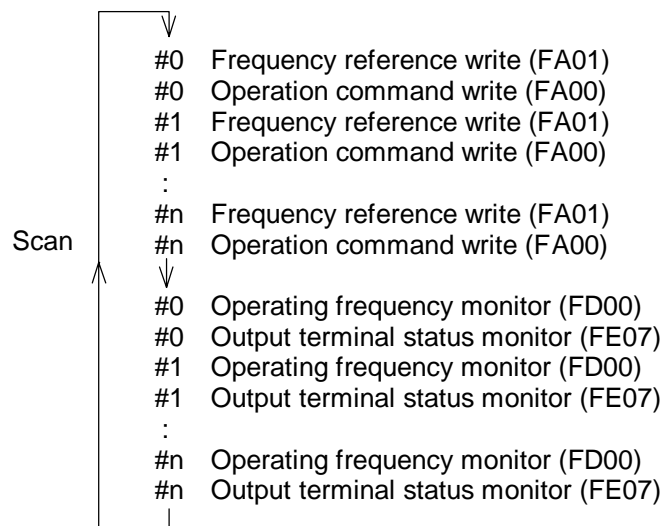

The maximum Inverter number $\#n$ is specified by the operand B .

The scan execution status and the Inverter communication status are stored in the operand $B+2$ to $B+7$.

The command data table is specified by the operand A and $A+1$.

When the instruction input is reset to OFF, the operation is stopped after receiving the response from the Inverter currently communicating.

Example

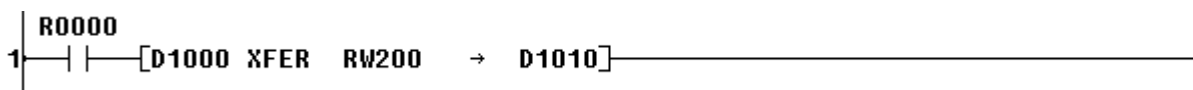

	Data table designation	Parameter & status	RS-485 port
D1000	4	RW200	D1010
D1001	2000	RW201	D1011
		RW202	
		RW203	
		RW204	
		RW205	
		RW206	
		RW207	

When the data for each operand are set as above, the following operation condition is specified.

- $RW200=5 \Rightarrow$ The max Inverter number is 5. Therefore T1-16S scans from #0 through #5 Inverters.
- $D1000=4$ & $D1001=2000 \Rightarrow$ D2000 is specified as the data table starting address.

7. Instructions

Data table:

Register	Data contents	Signal direction
D2000	#0 Operating frequency	← Read
D2001	#0 Output terminal status	← Read
D2002	#0 Frequency reference	→ Write
D2003	#0 Operation command	→ Write
D2004	#1 Operating frequency	← Read
D2005	#1 Output terminal status	← Read
D2006	#1 Frequency reference	→ Write
D2007	#1 Operation command	→ Write
⋮	⋮	
D2020	#5 Operating frequency	← Read
D2021	#5 Output terminal status	← Read
D2022	#5 Frequency reference	→ Write
D2023	#5 Operation command	→ Write

- The data format for the operating frequency and the frequency reference registers are 0.01 Hz units. For example, if it is 60 Hz, the corresponding register data is 6000.
- For the data format of the output terminal status register, refer to the Monitor mode (mode 1).
- The bit assignment of the operation command register is as follows. For details, refer to your Inverter manual.

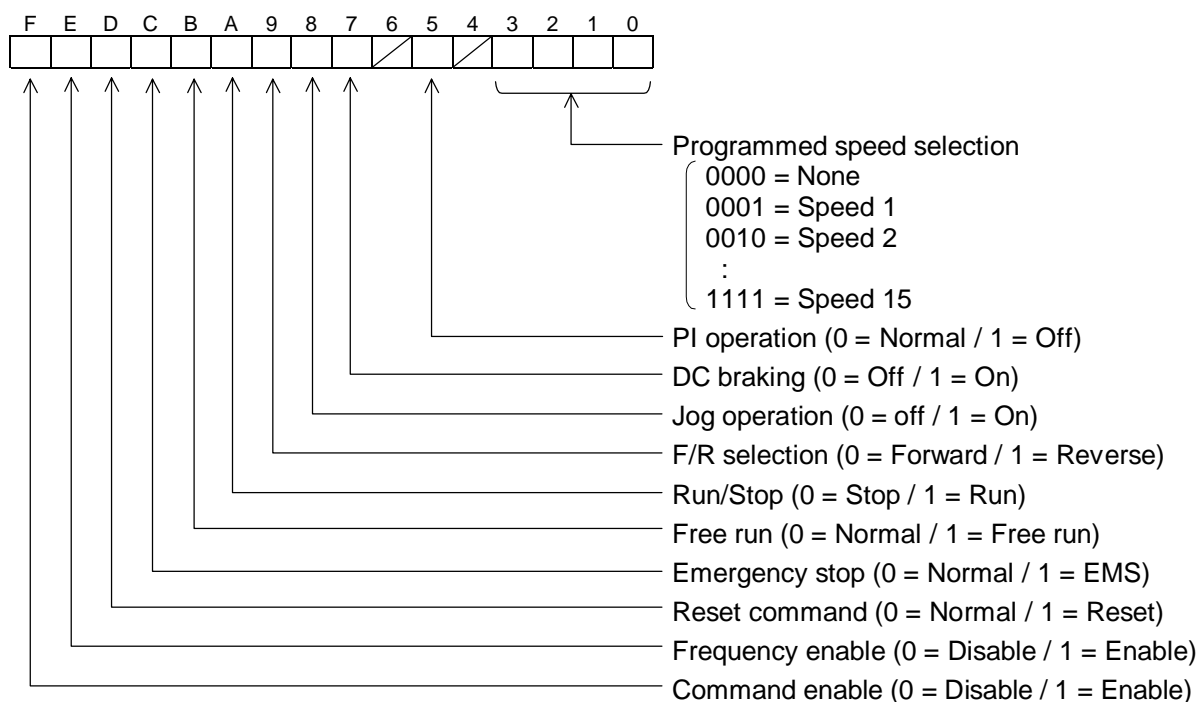

Example operation:

To operate the #0 Inverter at 30 Hz forward rotation, write the value 3000 in D2002 and HC400 in D2003. (HC400 = Bits F, E, A are 1, and others are 0)

The current operating frequency and the output terminal status of the #0 Inverter are stored in D2000 and D2001 respectively.

7. Instructions

< Monitor mode (Mode 1) >

When the instruction input comes ON with the operand $B+1$ is 1, the Monitor mode (mode 1) is selected.

In this mode, the T1-16S sends the following Read commands to the Inverters starting from #0 through the Inverter number specified by the operand B , and repeats.

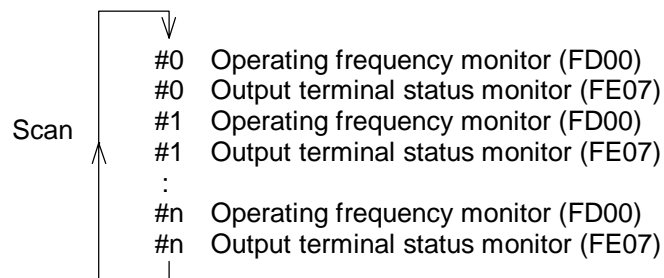

The maximum Inverter number # n is specified by the operand B .

The scan execution status and the Inverter communication status are stored in the operand $B+2$ to $B+7$.

The monitor data table is specified by the operand A and $A+1$.

When the instruction input is reset to OFF, the operation is stopped after receiving the response from the Inverter currently communicating.

Example

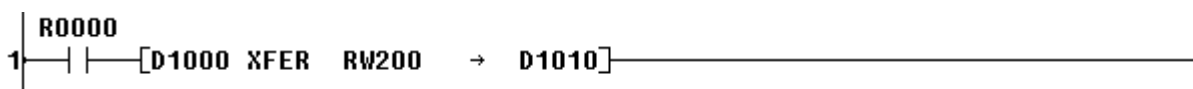

	Data table designation	Parameter & status	RS-485 port
D1000	3	RW200 19	D1010 H0030 (fixed)
D1001	100	RW201 1 (mode 1)	D1011 0 (fixed)
		RW202 Execution status	
		RW203 Comm error code	
		RW204	
		RW205 Inverter comms status map	
		RW206	
		RW207	

When the data for each operand are set as above, the following operation condition is specified.

- $RW200=19 \Rightarrow$ The max Inverter number is 19. Therefore T1-16S scans from #0 through #19 Inverters.
- $D1000=3$ & $D1001=100 \Rightarrow$ RW100 is specified as the data table starting address.

7. Instructions

Data table:

Register	Data contents	Signal direction
RW100	#0 Operating frequency	← Read
RW101	#0 Output terminal status	← Read
RW102	No use	
RW103	No use	
RW104	#1 Operating frequency	← Read
RW105	#1 Output terminal status	← Read
RW106	No use	
RW107	No use	
⋮	⋮	
RW176	#19 Operating frequency	← Read
RW177	#19 Output terminal status	← Read
RW178	No use	
RW179	No use	

- The data format for the operating frequency register is 0.01 Hz units. For example, if it is 60 Hz, the corresponding register data is 6000.
- The bit assignment of the output terminal status register is as follows. For details, refer to your Inverter manual.

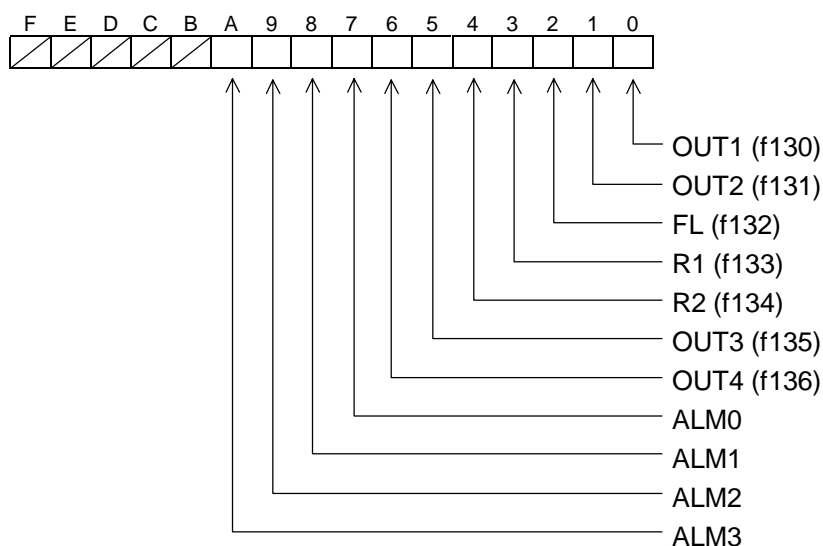

Example operation:

The current operating frequency and the output terminal status of the #0 Inverter are stored in RW100 and RW101 respectively.

If the #0 Inverter is operating at 55 Hz, the data 5500 is stored in RW100. If the OUT2 terminal of the #0 Inverter is ON, the bit 1 of RW101 (R1011) becomes 1.

7. Instructions

< Read command mode (Mode 2) >

When the instruction input comes ON with the operand $B+1$ is 2, the Read command mode (mode 2) is selected. In this mode, the T1-16S sends the user specified Read command to the Inverter specified by the operand B , and repeats.

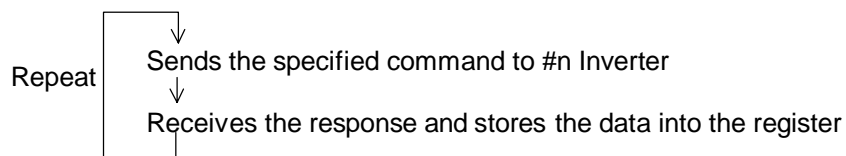

The target Inverter number $\#n$ is specified by the operand B .

The scan execution status and the Inverter communication status are stored in the operand $B+2$ to $B+7$.

The command setting register and the response data storing register is indirectly specified by the operand A and $A+1$.

When the instruction input is reset to OFF, the operation is stopped after receiving the response from the Inverter.

Example

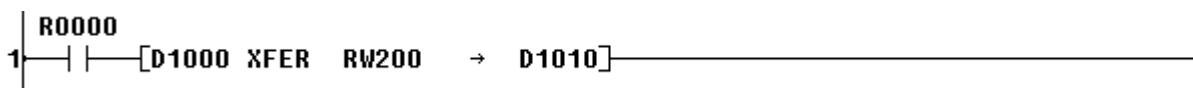

	Data table designation	Parameter & status	RS-485 port
D1000	4	RW200 3	D1010 H0030 (fixed)
D1001	3000	RW201 2 (mode 2)	D1011 0 (fixed)
		RW202 Execution status	
		RW203 Comm error code	
		RW204 Inverter comms status map	
		RW205	
		RW206	
		RW207	

When the data for each operand are set as above, the following operation condition is specified.

- RW200=3 ⇒ The target Inverter number is 3. Therefore T1-16S communicates with #3 Inverter.
- D1000=4 & D1001=3000 ⇒ D3000 is specified as the command setting register and D3001 is specified as the response data storing register.

Data table:

Register	Data contents	Signal direction
D3000	Command code	
D3001	Response data	← Read

Example operation:

For example, to read the output current from the #3 Inverter, set the command code HFE03 into D3000. Then the response data is stored in D3001. If the response data is 1915, it means 19.15%. For the command code and the data format of the response, refer to your Inverter manual.

7. Instructions

< Write command mode (Mode 3) >

When the instruction input comes ON with the operand $B+1$ is 3, the Write command mode (mode 3) is selected. In this mode, the T1-16S sends the user specified Write command to the Inverter specified by the operand B , and repeats.

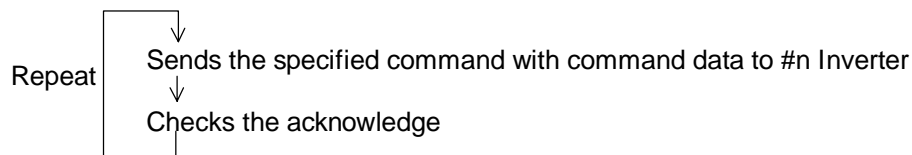

The target Inverter number $\#n$ is specified by the operand B .

The scan execution status and the Inverter communication status are stored in the operand $B+2$ to $B+7$.

The command code and the command data setting registers are indirectly specified by the operand A and $A+1$.

When the instruction input is reset to OFF, the operation is stopped after receiving the response from the Inverter.

Example

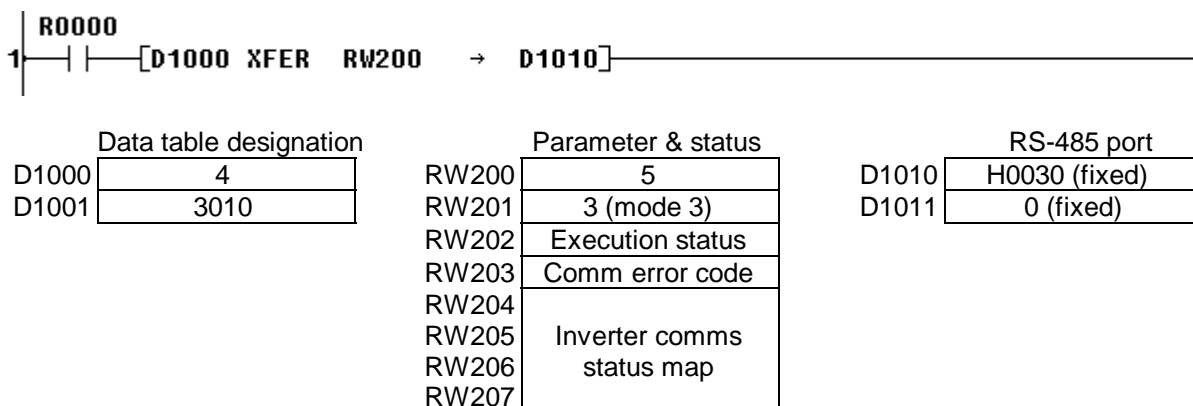

When the data for each operand are set as above, the following operation condition is specified.

- $RW200=5 \Rightarrow$ The target Inverter number is 5. Therefore T1-16S communicates with #5 Inverter.
- $D1000=4$ & $D1001=3010 \Rightarrow D3010$ is specified as the command code setting register and $D3011$ is specified as the command data setting register.

Data table:

Register	Data contents	Signal direction
D3010	Command code	\rightarrow Write
D3011	Command data	

Example operation:

For example, to write the acceleration time parameter (10 seconds) to the #5 Inverter, set the command code H0009 into D3010 and the value 100 into D3011.

For the command code and the command data format, refer to your Inverter manual.

7. Instructions

< Broadcast mode (Mode 4) >

When the instruction input comes ON with the operand $B+1$ is 4, the Broadcast mode (mode 4) is selected. In this mode, the T1-16S sends the user specified Write command to all the Inverters as broadcast.

This mode is useful to send Run/Stop command to all the Inverter at the same time.

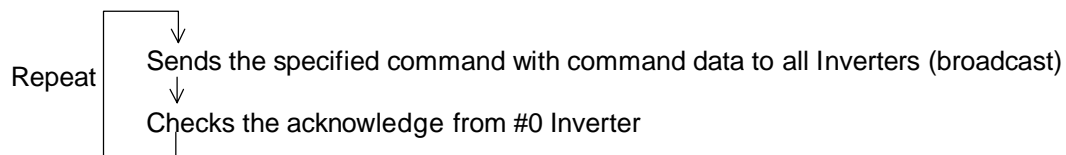

The Inverter number specified by the operand B is ignored.

The scan execution status and the Inverter communication status are stored in the operand $B+2$ to $B+7$. (only #0 Inverter responds)

The command code and the command data setting registers are indirectly specified by the operand A and $A+1$.

When the instruction input is reset to OFF, the operation is stopped after receiving the response from the Inverter.

Example

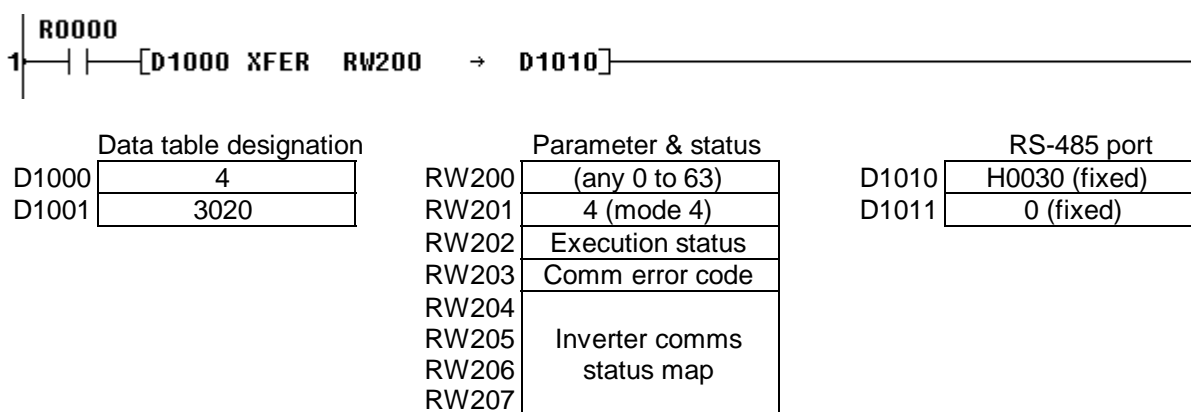

When the data for each operand are set as above, the following operation condition is specified.

- D1000=4 & D1001=3020 ⇒ D3020 is specified as the command code setting register and D3021 is specified as the command data setting register.

Data table:

Register	Data contents	Signal direction
D3020	Command code	→ Write
D3021	Command data	

Example operation:

For example, to send the Run forward command to all the Inverters, set the command code HFA00 into D3020 and the value HC400 into D3021.

For the command code and the command data format, refer to your Inverter manual.

7. Instructions

< Note >

- (1) The XFER instruction is not executed as error in the following cases. In these cases, the instruction error flag (ERF = S051) is set to ON. If the ERF is set to ON once, it remains ON until resetting to OFF by user program.
 - The RS-485 port designation is other than H0030 and 0.
 - The Inverter number designation is other than 0 to 63.
 - Operation mode setting for RS-485 port is other than the Inverter connection mode.
- (2) This XFER instruction must be programmed in the Main program.
- (3) During the instruction input is ON, the data contents in the data table specified by *A* can be changed. However, parameters specified by *B* cannot be changed.
- (4) In the Data exchange mode (mode 0) and the Monitor mode (mode 1), the T1-16S scans from #0 to the specified number. Therefore the Inverter number should be consecutive starting with 0.
If an Inverter is disconnected from the network, the T1-16S checks its existence periodically. When you turn off power to an Inverter for maintenance purpose and turn on again, it is recommended to reset the instruction input to re-configure the network.

Section 8

Special I/O Functions

- 8.1 Special I/O function overview, 256*
- 8.2 Variable input filter constant, 260*
- 8.3 High speed counter, 261*
- 8.4 Interrupt input function, 268*
- 8.5 Analog setting function, 270*
- 8.6 Pulse output function, 271*
- 8.7 PWM output function, 273*

8. Special I/O Functions

8.1 Special I/O function overview

The T1-16S supports the special I/O functions as listed below.

Function name		Function summary	Remarks
Variable input filter constant		Input filter constant (ON/OFF delay time) can be set by user program. The setting range is 0 to 15ms (1ms units). Default value is 10ms. This function is applied for X000 to X007 (8 points as a block).	SW16 setting is necessary to use this function. (Note)
High speed counter	Single phase up-counter	Counts the number of pulses of single phase pulse train. 2 channels of pulse input are available. The countable pulse rate is up to 5KHz for each channel. Channel 1 ... X000 count input, X002 reset input Channel 2 ... X001 count input, X003 reset input	Only one among these 4 functions can be selected. SW16 is used to select the function. (Note)
	Single phase speed-counter	Counts the number of pulses in a specified sampling time. The sampling time setting is 10 to 1000ms (10ms units). 2 channels of pulse input are available. The countable pulse rate is up to 5KHz for each channel. Channel 1 ... X000 count input Channel 2 ... X001 count input	
	Quadrature bi-pulse counter	Counts the 2-phase pulses whose phases are shifted 90° each other. Counts up when phase A precedes, and counts down when phase B precedes. The countable pulse rate is up to 5KHz. Phase A ... X000 Phase B ... X001 Reset X002	
Interrupt input function		Immediately activates the corresponding I/O interrupt program when the interrupt input is changed from OFF to ON (or ON to OFF). 2 points of interrupt input are available. X002 ... Interrupt 1 (I/O interrupt program #3) X003 ... Interrupt 2 (I/O interrupt program #4)	
Analog setting function		The value of the analog setting adjuster is converted into digital value (0 to 1000) and stored in the SW register. 2 adjusters are provided on the T1-16S. V0 ... SW30 V1 ... SW31	No function selection is required.
Pulse output function		Variable frequency pulse train can be output. The available pulse rate is 50 to 5000Hz (1Hz units). Y020 ... CW or Pulse (PLS) Y021 ... CCW or Direction (DIR)	Either one between these 2 functions can be used.
PWM output function		Variable duty cycle pulse train can be output. The available ON duty setting is 0 to 100% (1% units). Y020 ... PWM output	SW26 is used to select the function. (Note)

8. Special I/O Functions

Mode setting for the special I/O functions

These functions, except the analog setting function, are selected by setting data into SW16 and SW26 by user program. These registers work as mode setting registers for the special I/O functions. The data setting for these registers, i.e. mode setting for the special I/O functions, is effective only at the first scan.

Note) In the explanation below, HSC and INT mean the high speed counter and the interrupt input functions respectively.

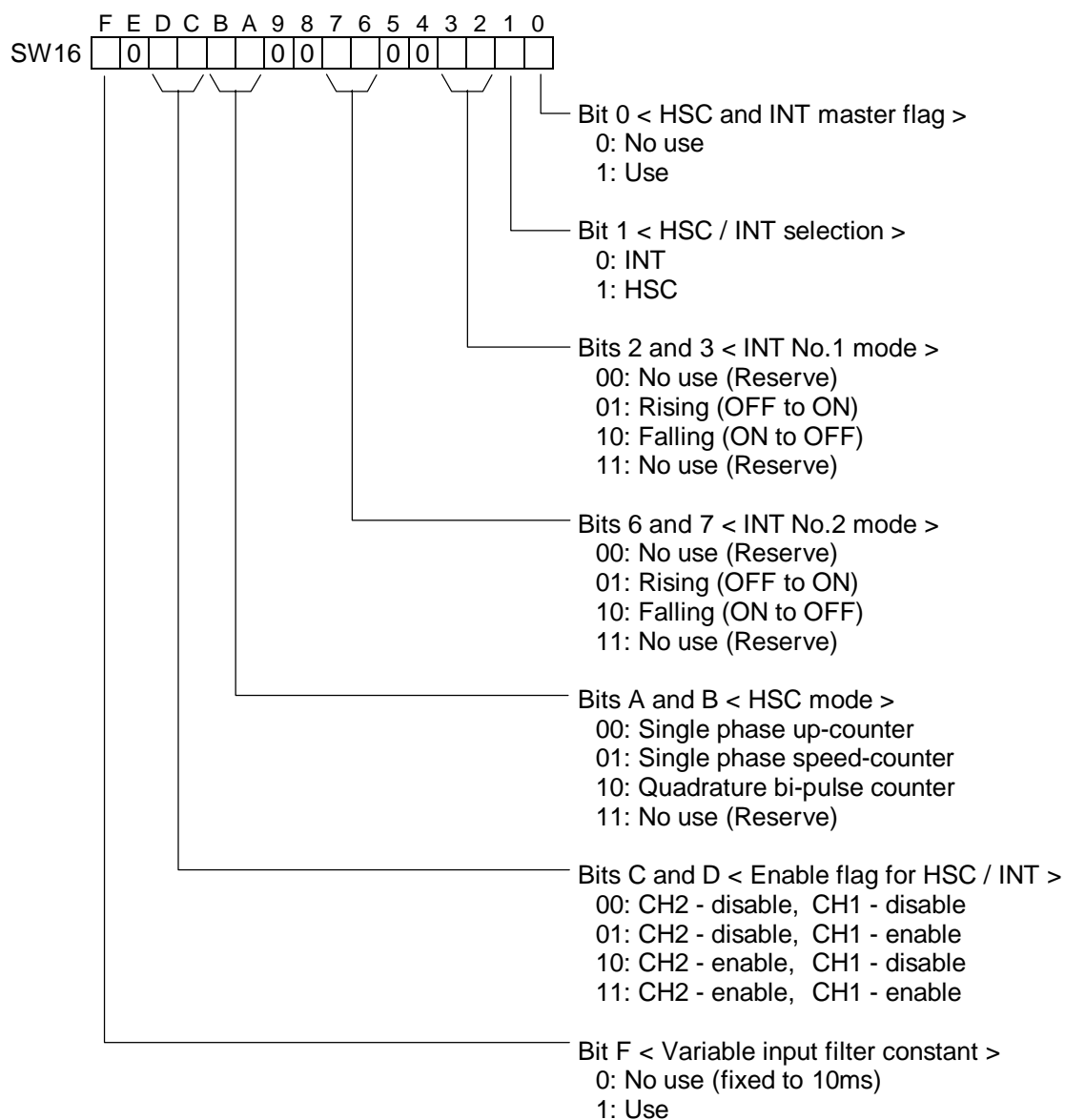

8. Special I/O Functions

Note) In the explanation below, P-OUT means the pulse output function.

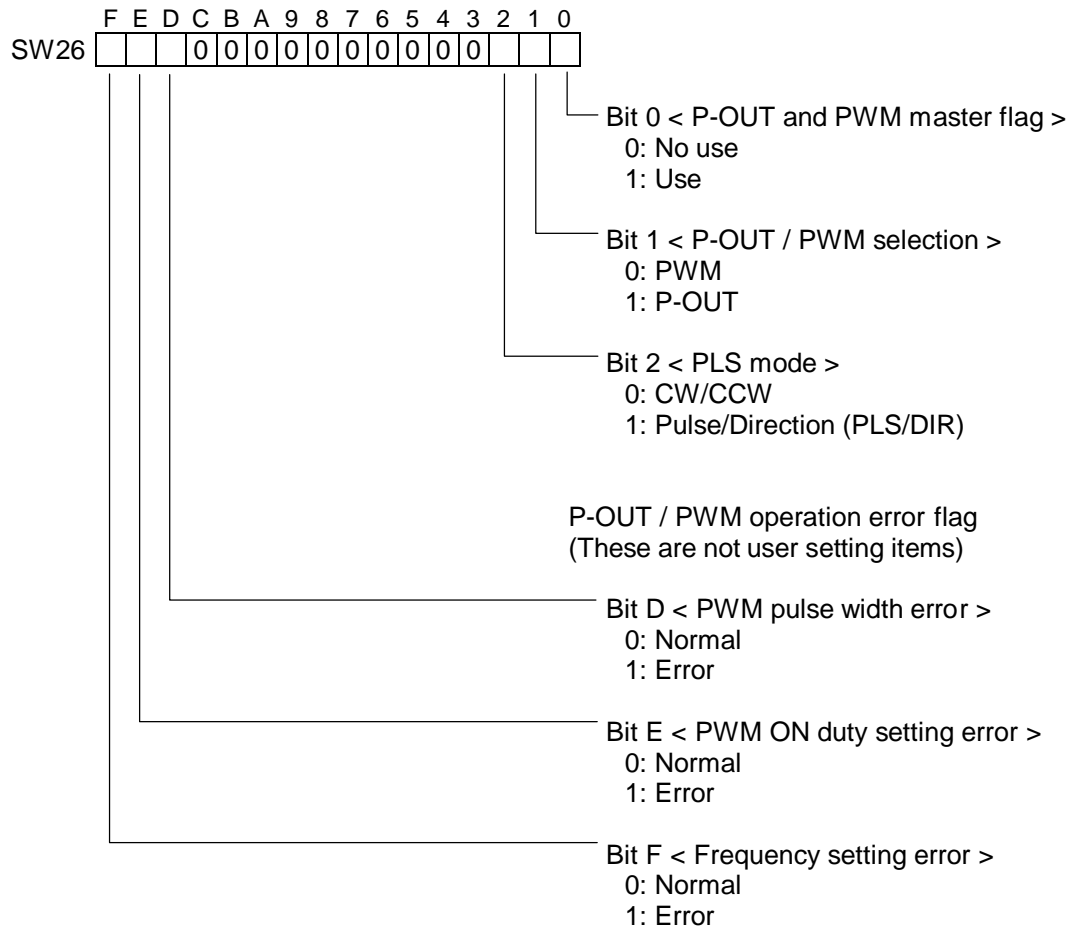

8. Special I/O Functions

The table below summarizes the mode setting data of each function. In the table, ‘-’ means do not care.

Variable input filter constant	SW16															
	F	E	D	C	B	A	9	8	7	6	5	4	3	2	1	0
Use	1	0	-	-	-	-	0	0	-	-	0	0	-	-	-	-

High speed counter		SW16																	
		F	E	D	C	B	A	9	8	7	6	5	4	3	2	1	0		
Single phase up-counter	Channel 1 only	-	0	0	1	0	0	0	0	0	0	0	0	0	0	1	1		
	Channel 2 only	-	0	1	0	0	0	0	0	0	0	0	0	0	0	0	1	1	
	Both channels	-	0	1	1	0	0	0	0	0	0	0	0	0	0	0	1	1	
Single phase speed-counter	Channel 1 only	-	0	0	1	0	1	0	0	0	0	0	0	0	0	0	1	1	
	Channel 2 only	-	0	1	0	0	1	0	0	0	0	0	0	0	0	0	0	1	1
	Both channels	-	0	1	1	0	1	0	0	0	0	0	0	0	0	0	0	1	1
Quadrature bi-pulse counter		-	0	0	0	1	0	0	0	0	0	0	0	0	0	0	1	1	

Interrupt input function		SW16																
		F	E	D	C	B	A	9	8	7	6	5	4	3	2	1	0	
Interrupt 1 only	Rising (OFF to ON)	-	0	0	1	0	0	0	0	0	0	0	0	0	0	1	0	1
	Falling (ON to OFF)	-	0	0	1	0	0	0	0	0	0	0	0	0	1	0	0	1
Interrupt 2 only	Rising (OFF to ON)	-	0	1	0	0	0	0	0	0	1	0	0	0	0	0	0	1
	Falling (ON to OFF)	-	0	1	0	0	0	0	0	0	1	0	0	0	0	0	0	1
Both interrupts 1 and 2	No.1 = Rising, No.2 = Rising	-	0	1	1	0	0	0	0	0	1	0	0	0	1	0	1	
	No.1 = Rising, No.2 = Falling	-	0	1	1	0	0	0	0	0	1	0	0	0	0	1	0	1
	No.1 = Falling, No.2 = Rising	-	0	1	1	0	0	0	0	0	0	1	0	0	1	0	0	1
	No.1 = Falling, No.2 = Falling	-	0	1	1	0	0	0	0	0	1	0	0	0	1	0	0	1

Pulse output function		SW26																
		F	E	D	C	B	A	9	8	7	6	5	4	3	2	1	0	
CW/CCW method		-	-	-	0	0	0	0	0	0	0	0	0	0	0	0	1	1
Pulse/Direction (PLS/DIR) method		-	-	-	0	0	0	0	0	0	0	0	0	0	0	1	1	1

PWM output function		SW26																
		F	E	D	C	B	A	9	8	7	6	5	4	3	2	1	0	
Use		-	-	-	0	0	0	0	0	0	0	0	0	0	0	0	0	1

For example, the following programs can be used to select the quadrature bi-pulse counter.

```

1—|↑|—[ SET S0160 ] [ SET S0161 ] [ SET S016B ]—————

           or

           (H0803)
1—|↑|—[ 02051 MOV SW016 ]—————

```

8. Special I/O Functions

8.2 Variable input filter constant

Function

The input filter constant (ON/OFF delay time) of the leading 8 points X000 to X007 can be specified by user program within the range of 0 to 15ms. The default is 10ms. The setting value is recognized at the first scan. Therefore, it cannot be changed after the second scan.

Related registers

SW16 Function selection. Refer to section 8.1.

SW17 Input filter constant value

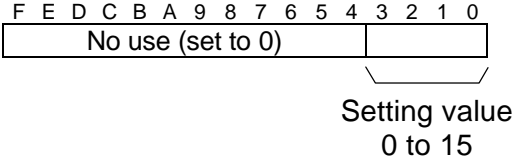

Operation

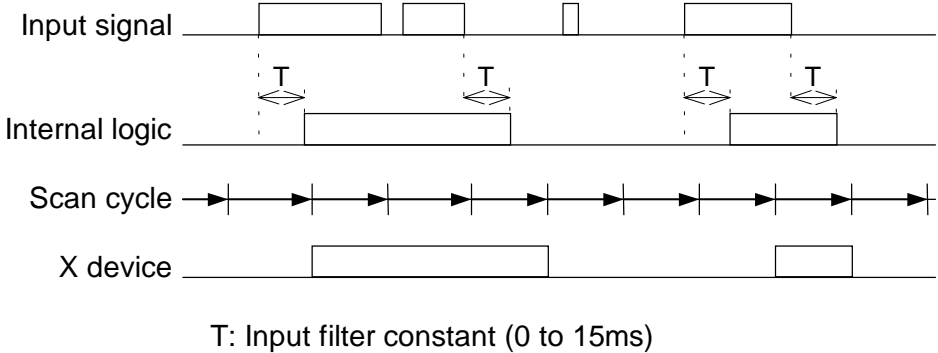

Sample program

```

1 | | | | [ SET S016F ] [ 00003 MOV SW017 ] |
  | | | |
  
```

This program sets the input filter constant to 3ms.

8. Special I/O Functions

8.3 High speed counter

8.3.1 Single phase up-counter

Function

When the count input is changed from OFF to ON, the count value is increased by 1. When the count value reaches the set value, the count value is reset to 0, and I/O interrupt program is activated (if the interrupt enable flag is ON). The count value is reset to 0 when the reset input comes ON.

This counter operation is enabled while the soft-gate is ON. The count value is reset to 0 when the soft-gate is changed from ON to OFF.

The set value is set internally at the timing of the soft-gate changing from OFF to ON. When the soft-gate is OFF, the count value can be changed by writing the data into the set value register and setting the count preset flag to ON.

The count value range is H0000 to HFFFF (16-bit data).

Hardware condition

Count input (X000 and X001)

ON/OFF pulse width: 100 μ s or more (max. 5KHz)

Reset input (X002 and X003)

ON/OFF duration: 2ms or more

Related registers

SW16: Function selection. Refer to section 8.1.

Function	Register/device		Remarks
	Channel 1	Channel 2	
Count input	X000	X001	(Note)
Reset input	X002	X003	
Set value	SW18	SW20	Data range: H0000 to HFFFF
Count value	SW22	SW23	
Soft-gate	S240	S248	Operation is enabled when ON
Interrupt enable	S241	S249	Interrupt is enabled when ON
Count preset	S243	S24B	Used to preset the counter value

Note) When both channels are used, X000 to X003 cannot be used as normal input devices. However, if either one channel is used, these inputs for unused channel can be used as normal input devices.

Interrupt assignment

Channel 1 ... I/O interrupt program #1

Channel 2 ... I/O interrupt program #2

8. Special I/O Functions

Operation

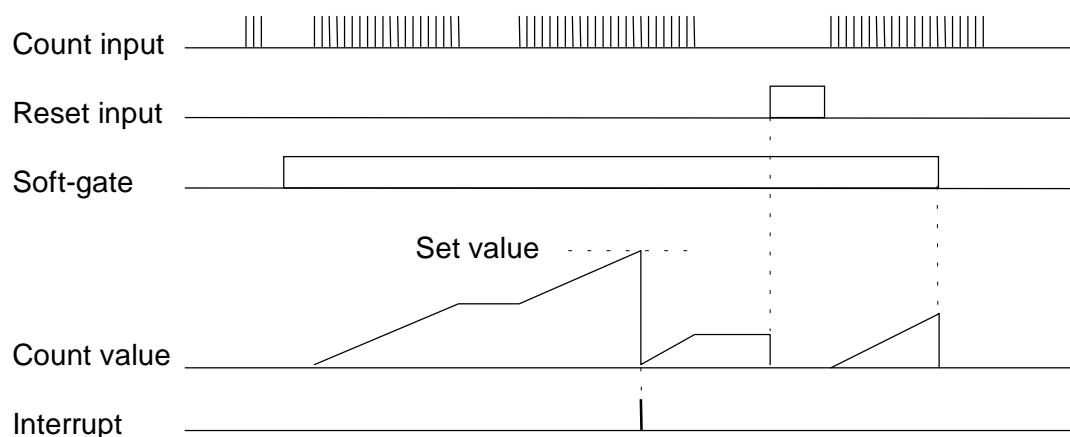

Sample program

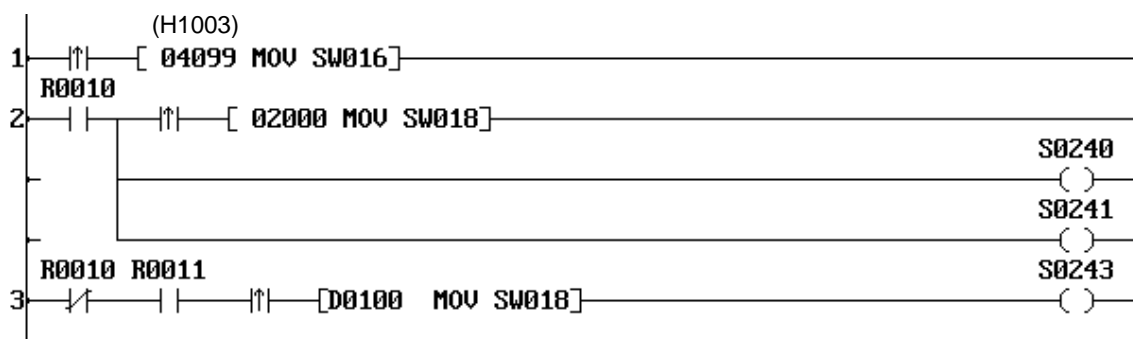

In this example, 4099 (H1003) is set in SW16. As a result, the single phase up-counter (channel 1 only) is selected.

When R010 comes ON, the data 2000 is written into the set value register (SW18).

While R010 is ON, the soft-gate (S240) and the interrupt enable flag (S241) are set to ON to enable the counter operation.

The counter works as a ring counter with the set value 2000. The count value is stored in SW22.

When R010 is OFF and R011 comes ON, the count value is preset to the data of D0100.

8. Special I/O Functions

8.3.2 Single phase speed-counter

Function

This function counts the number of changes of the count input from OFF to ON during the every specified sampling time. The count value in a sampling time is stored in the hold value register.

This counter operation is enabled while the soft-gate is ON. When the soft-gate is OFF, the hold value is cleared to 0.

The setting range of the sampling time is 10 to 1000ms (10ms units).

The count value range is H0000 to HFFFF (16-bit).

Hardware condition

Count input (X000 and X001)

ON/OFF pulse width: 100 μ s or more (max. 5KHz)

Related registers

SW16: Function selection. Refer to section 8.1.

Function	Register/device		Remarks
	Channel 1	Channel 2	
Count input	X000	X001	(Note 2)
Sampling time	SW18	SW20	Data range: 1 to 100 (Note 1)
Hold value	SW22	SW23	Data range: H0000 to HFFFF
Soft-gate	S240	S248	Operation is enabled when ON

Note 1) The setting data range of the sampling time is 1 to 100. (10ms multiplier)

Note 2) When both channels are used, X000 and X001 cannot be used as normal input devices. However, if either one channel is used, the input for unused channel can be used as normal input devices.

Interrupt assignment

No interrupt function.

8. Special I/O Functions

Operation

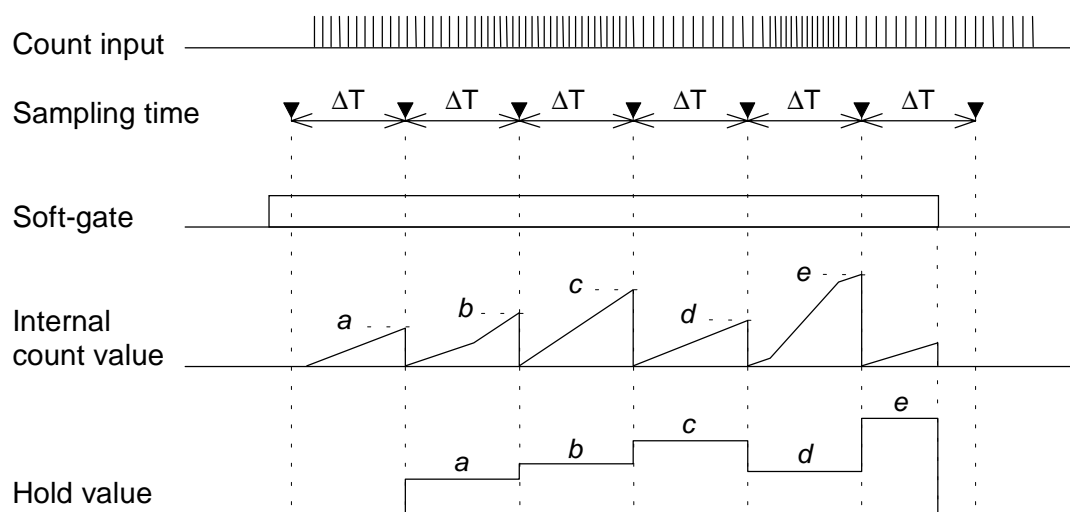

Sample program

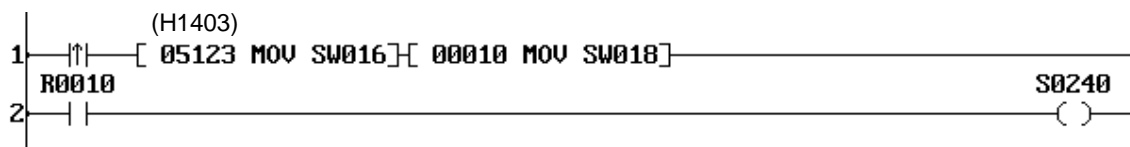

In this example, 5123 (H1403) is set in SW16. As a result, the single phase speed-counter (channel 1 only) is selected.

The sampling time is set as 100ms, because 10 is written in SW18.

While R010 is ON, the soft-gate (S240) is set to ON, and the speed-counter works.

The hold value is stored in SW22.

8. Special I/O Functions

8.3.3 Quadrature bi-pulse counter

Function

This function counts up or down the quadrature bi-pulse (2-phase pulses whose phases are shifted 90° each other). Counts up when phase A precedes, and counts down when phase B precedes. Both rising and falling edges of each phase are counted. Consequently, 4 times count value against the pulse frequency is obtained.

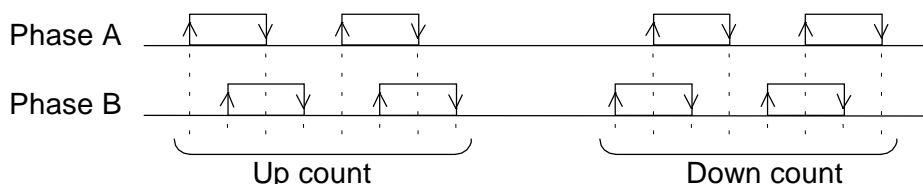

When the count value reaches the comparison value 1 (or 2), the I/O interrupt program #1 (or #2) is activated (if the interrupt enable flag for each is ON). This counter operation is enabled while the soft-gate is ON. The count value is reset to 0 when the soft-gate is changed from ON to OFF. The count value is also reset to 0 when the reset input comes ON.

When the soft-gate is OFF, the count value can be changed by writing the data into the comparison value 1 (or 2) register and setting the count preset flag 1 (or 2) to ON. The comparison value 1 and 2 can be changed even when the soft-gate is ON. The count value range is -2147483648 to 2147483647 (32-bit data).

Hardware condition

Phase A and phase B (X000 and X001)
 ON/OFF pulse width: 100μs or more (max. 5KHz)
 Reset input (X002)
 ON/OFF duration: 2ms or more

Related registers

SW16: Function selection. Refer to section 8.1.

Function	Register/device	Remarks
Phase A	X000	
Phase B	X001	
Reset input	X002	
Comparison value 1	SW19-SW18	Data range: -2147483648 to 2147483647
Comparison value 2	SW21-SW20	
Count value	SW23-SW22	
Soft-gate	S240	Operation is enabled when ON
Interrupt enable 1	S241	Interrupt 1 is enabled when ON
Count preset 1	S243	Used to preset the count value
Interrupt enable 2	S249	Interrupt 2 is enabled when ON
Count preset 2	S24B	Used to preset the count value

8. Special I/O Functions

Interrupt assignment

Comparison value 1 ... I/O interrupt program #1

Comparison value 2 ... I/O interrupt program #2

Operation

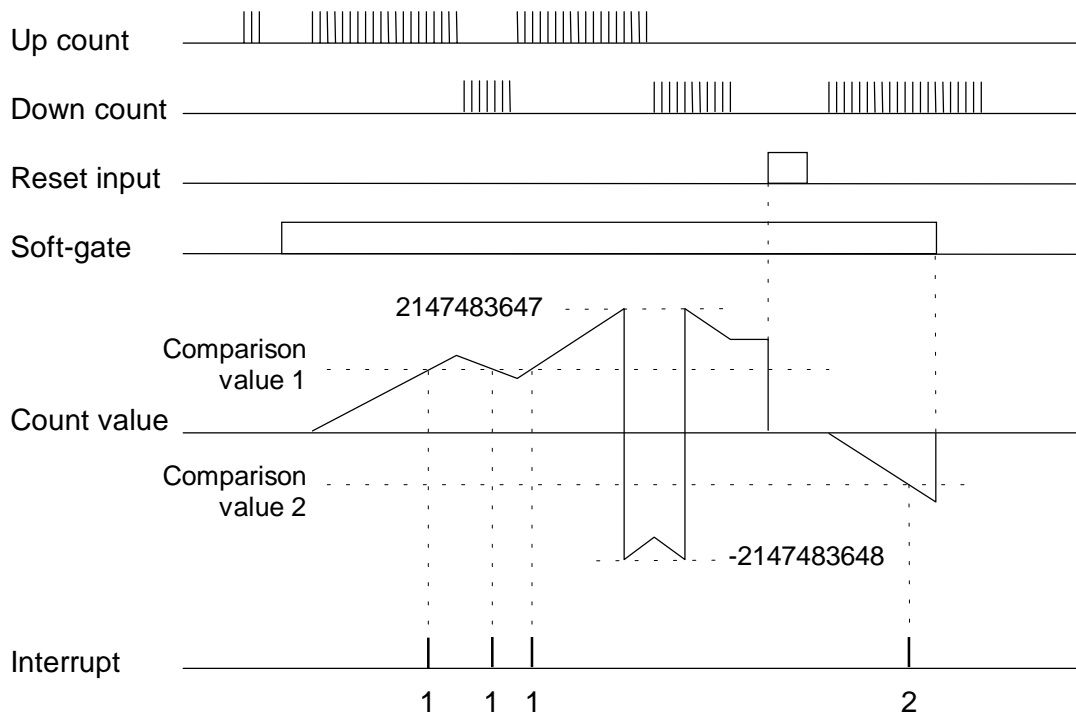

8. Special I/O Functions

Sample program

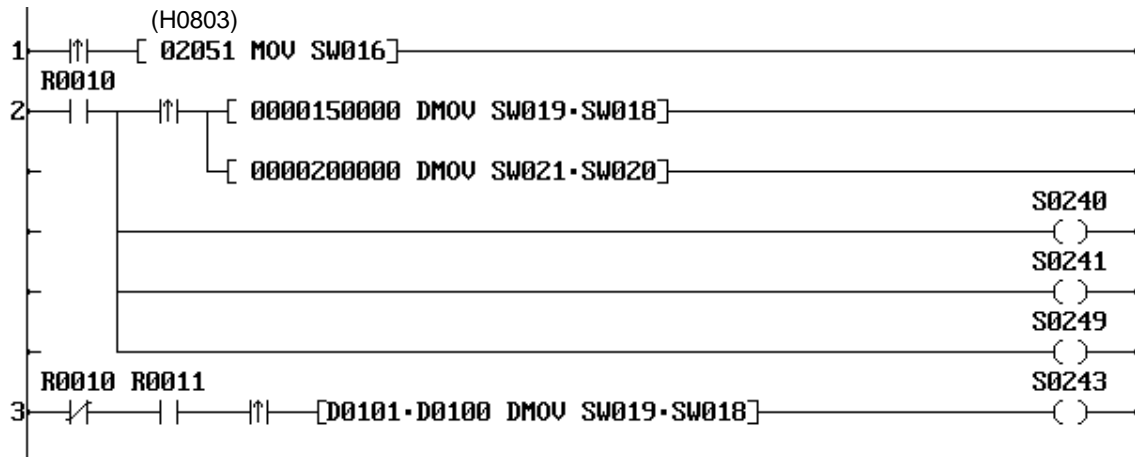

In this example, 2051 (H0803) is set in SW16. As a result, the quadrature bi-pulse counter is selected.

When R010 comes ON, the data 150000 is set into the comparison value 1 register (SW19-SW18), and 200000 is set into the comparison value 2 register (SW21-SW20). While R010 is ON, the soft-gate (S240), the interrupt enable flag 1 (S241) and the interrupt enable flag 2 (S249) are set to ON to enable the counter operation. The count value is stored in SW23-SW22.

When R010 is OFF and R011 comes ON, the count value is preset to the data of D0101-D0100.

8. Special I/O Functions

8.4 Interrupt input function

Function

When the signal state of the interrupt input is changed from OFF to ON (or ON to OFF), the corresponding I/O interrupt program is activated immediately. Up to 2 interrupt inputs can be used. The interrupt generation condition can be selected either rising edge (OFF to ON) or falling edge (ON to OFF) for each input. The I/O interrupt program #3 is corresponding to the interrupt input 1, and the I/O interrupt program #4 is corresponding to the interrupt input 2.

Hardware condition

Interrupt input (X002 and X003)
ON/OFF pulse width: 100 μ s or more

Related registers

SW16: Function selection. Refer to section 8.1.

Interrupt input 1	X002
Interrupt input 2	X003

Interrupt assignment

Interrupt input 1 ... I/O interrupt program #3
Interrupt input 2 ... I/O interrupt program #4

Operation



The above operation example is the case of rising edge setting for both inputs.

8. Special I/O Functions

Sample program

Main program

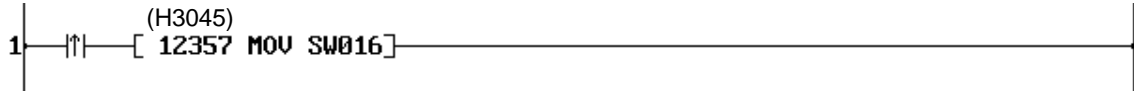

I/O interrupt program #3

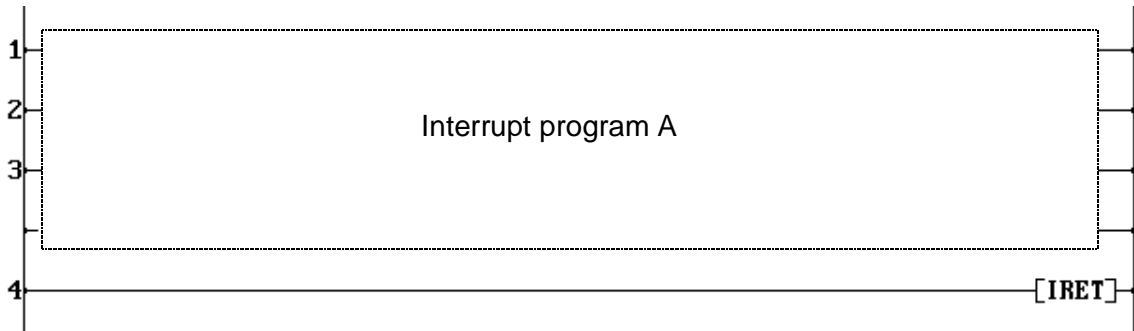

I/O interrupt program #4

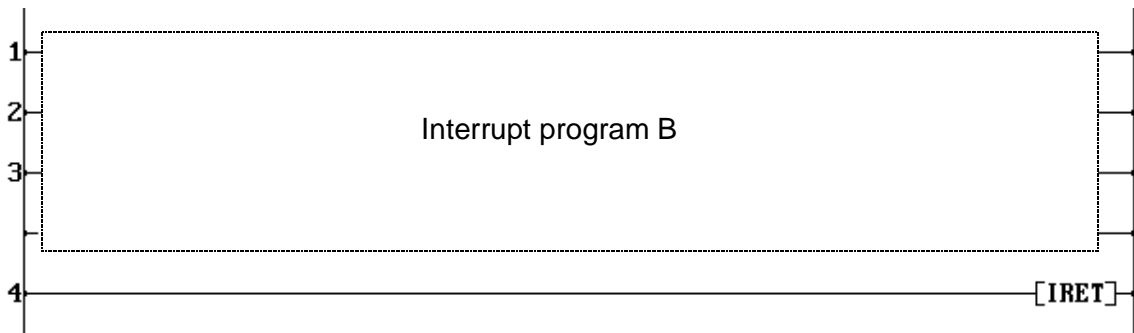

In this example, 12357 (H3045) is set in SW16. As a result, the interrupt input function (2 points, rising for both) is selected.

When X002 is changed from OFF to ON, the interrupt program A is executed. When X003 is changed from OFF to ON, the interrupt program B is executed.



Even if the Direct I/O instruction is used in the interrupt program, the corresponding input state (X002 or X003) cannot be confirmed. Because the interrupt is generated before internal updating of the input states.

8. Special I/O Functions

8.6 Pulse output function

Function

This function is used to output a variable frequency pulse train. The controllable pulse frequency is 50 to 5000 Hz (1 Hz units).

The output mode can be selected either CW/CCW or Pulse/Direction (PLS/DIR).

In the CW/CCW mode, CW pulse is output when the frequency setting is positive (50 to 5000), and CCW pulse is output when it is negative (-50 to -5000).

In the PLS/DIR mode, DIR is OFF when the frequency setting is positive (50 to 5000), and DIR is ON when it is negative (-50 to -5000).

< CW/CCW mode >

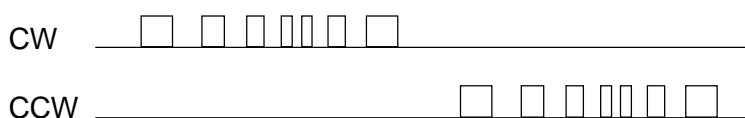

< PLS/DIR mode >

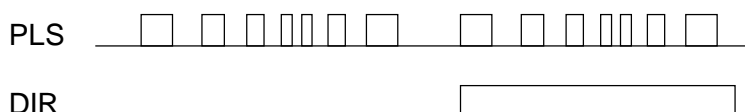

In the both modes, pulse output is enabled when the pulse enable flag is ON. While the pulse enable flag is ON, the pulse frequency can be changed by changing the frequency setting value. However, the pulse direction (the sign of the frequency setting) cannot be changed when the pulse enable flag is ON.

This function can be used to control the speed of a stepping motor, etc.

Related registers

SW26: Function selection. Refer to section 8.1.

Function		Register/ device	Remarks
CW/CCW	PLS/DIR		
CW pulse	PLS	Y020	
CCW pulse	DIR	Y021	
Pulse enable flag		S270	Output is enabled when ON
Frequency setting register		SW28	Data range: -5000 to -50, 50 to 5000
Frequency setting error flag		S26F	ON at error (reset OFF automatically)

Note) The allowable value range of the frequency setting (SW28) is -5000 to -50 and 50 to 5000. If the value is out of this range or the sign is changed while the pulse enable flag (S270) is ON, the frequency setting error flag (S26F) comes ON. (Pulse output operation is continued with previous frequency setting)

8. Special I/O Functions

Operation

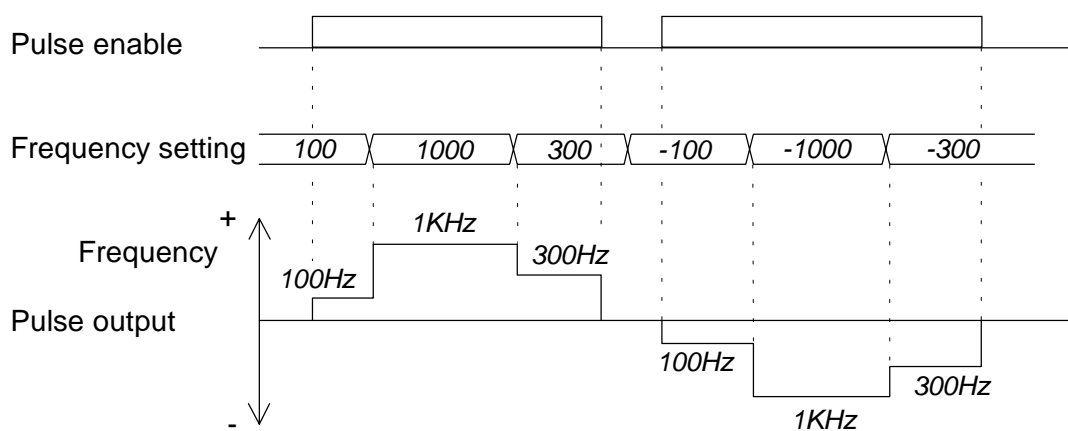

Sample program

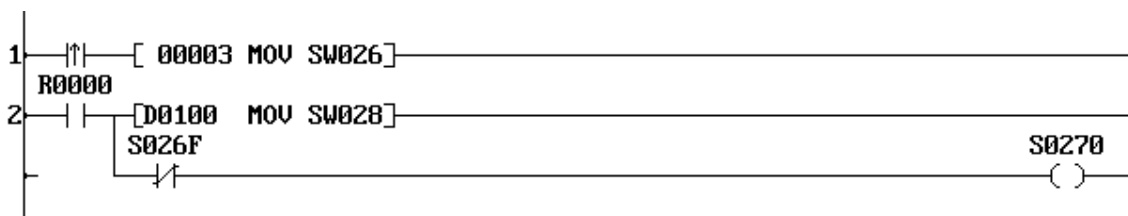

In this example, 3 (H0003) is set in SW26. As a result, the CW/CCW mode pulse output function is selected.

When R000 is ON, the pulse output is started with the frequency designated by D0100.

If an invalid frequency is designated, the frequency setting error flag (S26F) comes ON and the pulse enable flag (S270) is turned OFF. Then the pulse output is stopped.

8. Special I/O Functions

8.7 PWM output function

Function

This function is used to output a variable duty cycle pulse train. The controllable duty cycle is 0 to 100 % (1 % units).

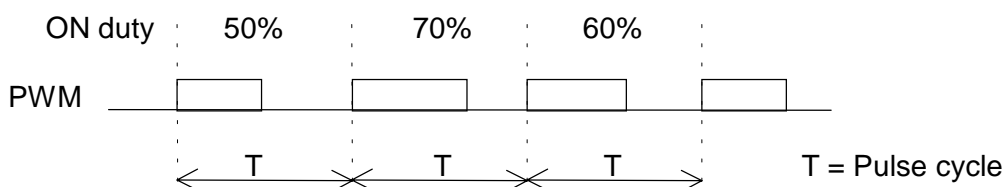

The PWM output is enabled when the pulse enable flag is ON. While the pulse enable flag is ON, the duty cycle (ON duty) can be changed by changing the duty setting value (0 to 100).

The frequency setting is available in the range of 50 to 5000 Hz (1 Hz units) before turning ON the pulse enable flag. The frequency changing is not allowed while the pulse enable is ON.

Note that the minimum ON/OFF pulse duration is 100 μ s. Therefore, the controllable ON duty range is limited depending on the frequency setting as follows. If the ON duty setting value is not available (within 0 to 100), the pulse width error flag comes ON. (PWM output operation is continued but the duty cycle is not guaranteed)

Frequency	Cycle time	Available ON duty
50 - 100 Hz	20 - 10 ms	0 to 100 %
200 Hz	5 ms	0, 2 to 98, 100 %
1000 Hz	1 ms	0, 10 to 90, 100 %
5000 Hz	200 μ s	0, 50, 100 %

Related registers

SW26: Function selection. Refer to section 8.1.

Function	Register/device	Remarks
PWM pulse	Y020	
Pulse enable flag	S270	Output is enabled when ON
Frequency setting register	SW28	Data range: 50 to 5000
ON duty setting register	SW29	Data range: 0 to 100
Pulse width error flag	S26D	ON at error (reset OFF automatically)
ON duty setting error flag	S26E	ON at error (reset OFF automatically)
Frequency setting error flag	S26F	ON at error (reset OFF automatically)

Note) If the setting value of SW28 or SW29 is out of the allowable range, the frequency setting error flag (S26F) or the ON duty setting error flag (S26E) comes ON. (PWM output operation is continued with previous ON duty setting)

8. Special I/O Functions

Operation

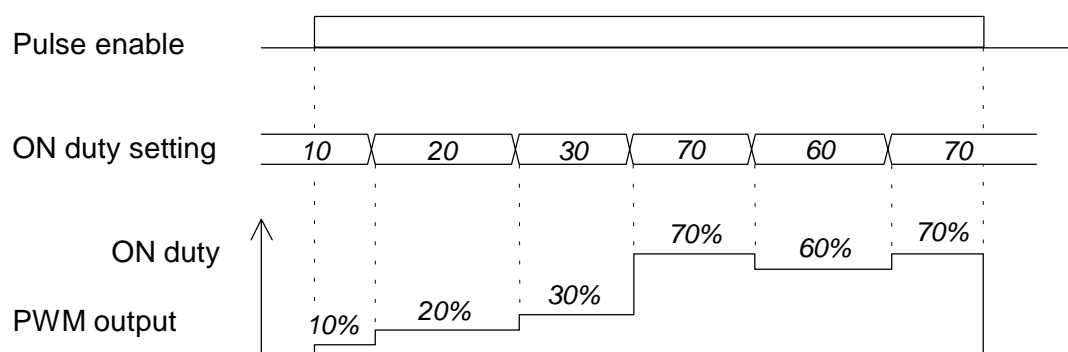

Sample program

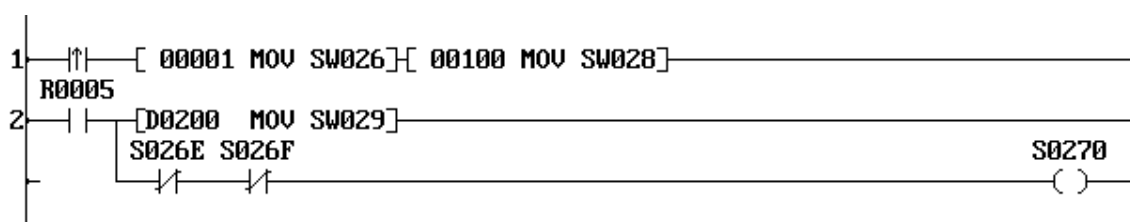

In this example, 1 (H0001) is set in SW26 and 100 is set in SW28. As a result, 100 Hz PWM output function is selected.

When R005 is ON, the PWM output is started with the duty cycle designated by D0200.

If an invalid ON duty is designated, the ON duty setting error flag (S26E) comes ON and the pulse enable flag (S270) is turned OFF. Then the PWM output is stopped.

Section 9

Maintenance and Checks

- 9.1 *Precautions during operation, 276*
- 9.2 *Daily checks, 277*
- 9.3 *Periodic checks, 278*
- 9.4 *Maintenance parts, 279*
- 9.5 *Battery, 280*

9. Maintenance and Checks

9.1 Precautions during operation

When the T1-16S is in operation, you should pay attention to the following items.

- (1) The programmer cable can be plugged or unplugged while the T1-16S is in operation. When you try to do it, do not touch the connector pins. This may cause malfunction of the T1-16S owing to static electricity.
- (2) Do not plug nor unplug the expansion cable during power on. This can cause damage to the equipment. Furthermore, to avoid malfunction of the T1-16S owing to static electricity, do not touch the cable ends.
- (3) Do not touch any terminals while the T1-16S is in operation, even if the terminals are not live parts. This may cause malfunction of the T1-16S owing to static electricity.
- (4) Do not touch the expansion connector pins while the T1-16S is in operation. This may cause malfunction of the T1-16S owing to static electricity.
Fix the expansion connector cover if the expansion connector is not used.
- (5) Turn off power when a battery installs and removes.

9. Maintenance and Checks

9.2 Daily checks



CAUTION

1. Pay special attention during the maintenance work to minimize the risk of electrical shock.
2. Turn off power immediately if the T1-16S or related equipment is emitting smoke or odor. Operation under such situation can cause fire or electrical shock.

To maintain the system and to prevent troubles, check the following items on daily basis.

Item	Check		Corrective measures
Status LEDs	PWR (power)	Lit when internal 5V is normal.	If the LEDs are not normal, see 10. Troubleshooting.
	RUN	Lit when operating normally.	
	FLT (fault)	Not lit when operating normally.	
Mode control switch	Check that the mode control switch is in R (RUN) side. Normal operation is performed when this switch is in R (RUN) side.		Turn this switch to R (RUN) side.
Input LEDs	Lit when the corresponding input is ON.		<ul style="list-style-type: none"> • Check that the input terminal screw is not loose. • Check that the input terminal block is not loose. • Check that the input voltage is within the specified range.
Output LEDs	Lit when the output is ON and the corresponding load should operate.		<ul style="list-style-type: none"> • Check that the output terminal screw is not loose. • Check that the output terminal block is not loose. • Check that the output voltage is within the specified range.

9. Maintenance and Checks

9.3 Periodic checks



CAUTION

1. Pay special attention during the maintenance work to minimize the risk of electrical shock.
2. Turn off power immediately if the T1-16S or related equipment is emitting smoke or odor. Operation under such situation can cause fire or electrical shock.

Check the T1-16S based on the following items every six months. Also perform checks when the operating environment is changed.

Item	Check	Criteria
Power supply	Measure the power voltage at the T1-16S's power terminals.	85 - 132/170 - 264Vac (AC PS) 20.4 - 28.8Vdc (DC PS)
	Check that the terminal screw is not loose.	Not loose
	Check that the power cable is not damaged.	Not damaged
Installation condition	Check that the unit is installed securely.	Not loose, no play
	Check that the I/O module is inserted securely. (if any)	Not loose, no play
	Check that the expansion rack/unit is installed securely. (if any)	Not loose, no play
	Check that the expansion cable is connected securely and the cable is not damaged. (if any)	Not loose, not damaged
	Check that the I/O module on the expansion rack is inserted securely. (if any)	Not loose, no play
Input/output	Measure the input/output voltage at the T1-16S's terminals.	The voltage must be within the specified range.
	Check the input status LEDs.	The LED must light normally.
	Check the output status LEDs.	The LED must light normally.
	Check that the terminal block is installed securely.	Not loose, no play
	Check that the terminal screw is not loose and the terminal has a sufficient distance to the next terminal.	Not loose, not contacting the next terminal
	Check that the each I/O wire is not damaged.	Not damaged

9. Maintenance and Checks

(Periodic checks - continued)

Item	Check	Criteria
Environment	Check that the temperature, humidity, vibration, dust, etc. are within the specified range.	Must be within the range of general specification.
Programming tool	Check that the functions of the programming tool are normal.	Monitoring and other operations are available.
	Check that the connector and cable are not damaged.	Not damaged
User program	Check that the T1-16S program and the master program (saved on a floppy disk, etc.) are the same.	No compare error

9.4 Maintenance parts

To recover from trouble quickly, it is recommended to keep the following spare parts.

Item	Quantity	Remarks
T1-16S basic unit	1	Prepare at least one to minimize the down-time of the controlled system.
Programming tool	1	Useful for the troubleshooting procedure.
Master program	As required	Saved on a floppy disk, etc.
Expansion rack or unit (if any)	1	
I/O module (if any)	One of each type used	
Fuse for I/O module (if any)	One of each type used	
Battery (CR2032)	1	

These spare parts should not be stored in high temperature and/or humidity locations.

9. Maintenance and Checks

9.5 Battery

(1) Install

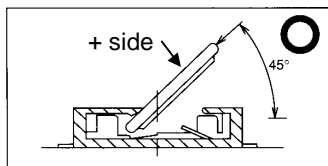

Insert the battery by an angle of 45°. (Turn + side into an upside.)

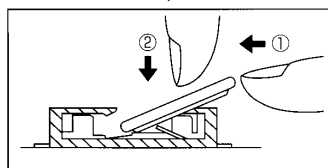

(1) Push the battery horizontal direction.

(2) Push from upside and lock.

(2) Eject

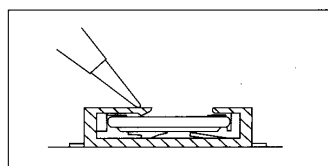

Push the center of the tab by a finger or a pen. Then the battery will be unlocked.

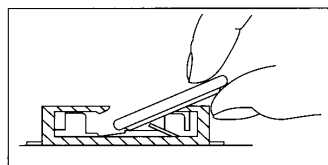

Remove the battery.



NOTE

1. Turn off power when installing or removing the battery for safety.
2. The battery type is CR2032. Do not use other types of battery. Use of another battery may present a risk of fire or explosion.
3. Dispose of used battery promptly. Keep away from children. Do not disassemble and do not dispose of in fire.

Section 10

Troubleshooting

- 10.1 Troubleshooting procedure, 282*
- 10.2 Self-diagnostic items, 288*

10. Troubleshooting

10.1 Troubleshooting procedure



CAUTION

1. Pay special attention during the troubleshooting to minimize the risk of electrical shock.
2. Turn off power immediately if the T1-16S or related equipment is emitting smoke or odor. Operation under such situation can cause fire or electrical shock.
3. Turn off power before removing or replacing units, modules, terminal blocks or wires. Failure to do so can cause electrical shock or damage to the T1 and related equipment.
4. Contact Toshiba for repairing if the T1-16S or related equipment is failed. Toshiba will not guarantee proper operation nor safety for unauthorized repairing.

If a trouble occurs, determine whether the cause lies in the mechanical side or in the control system (PLC) side. A problem may cause a secondary problem, therefore, try to determine the cause of trouble by considering the whole system.

If the problem is found in the T1-16S, check the following points:

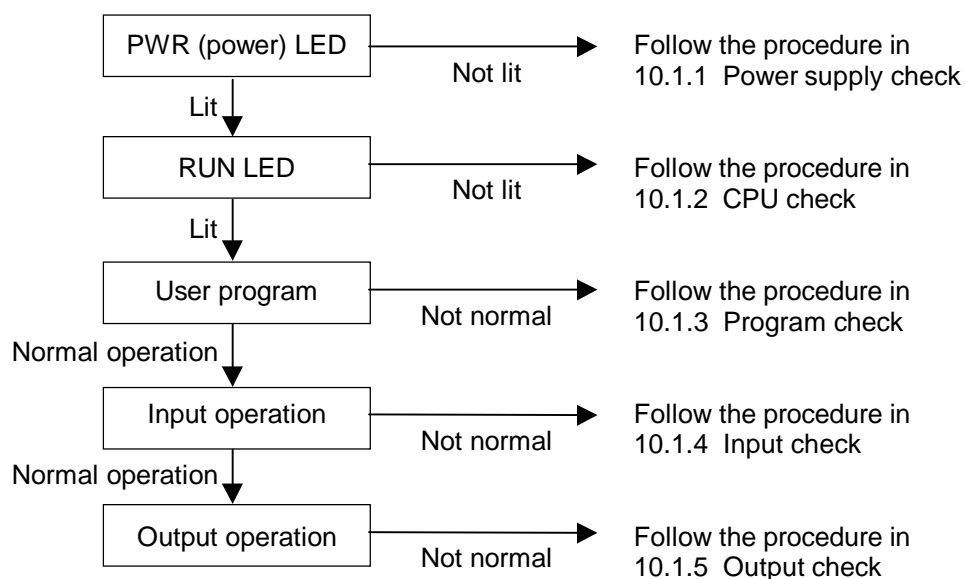

Also refer to section 10.1.6 for environmental problem.

10. Troubleshooting

10.1.1 Power supply check

If the PWR (power) LED is not lit after power on, check the following points.

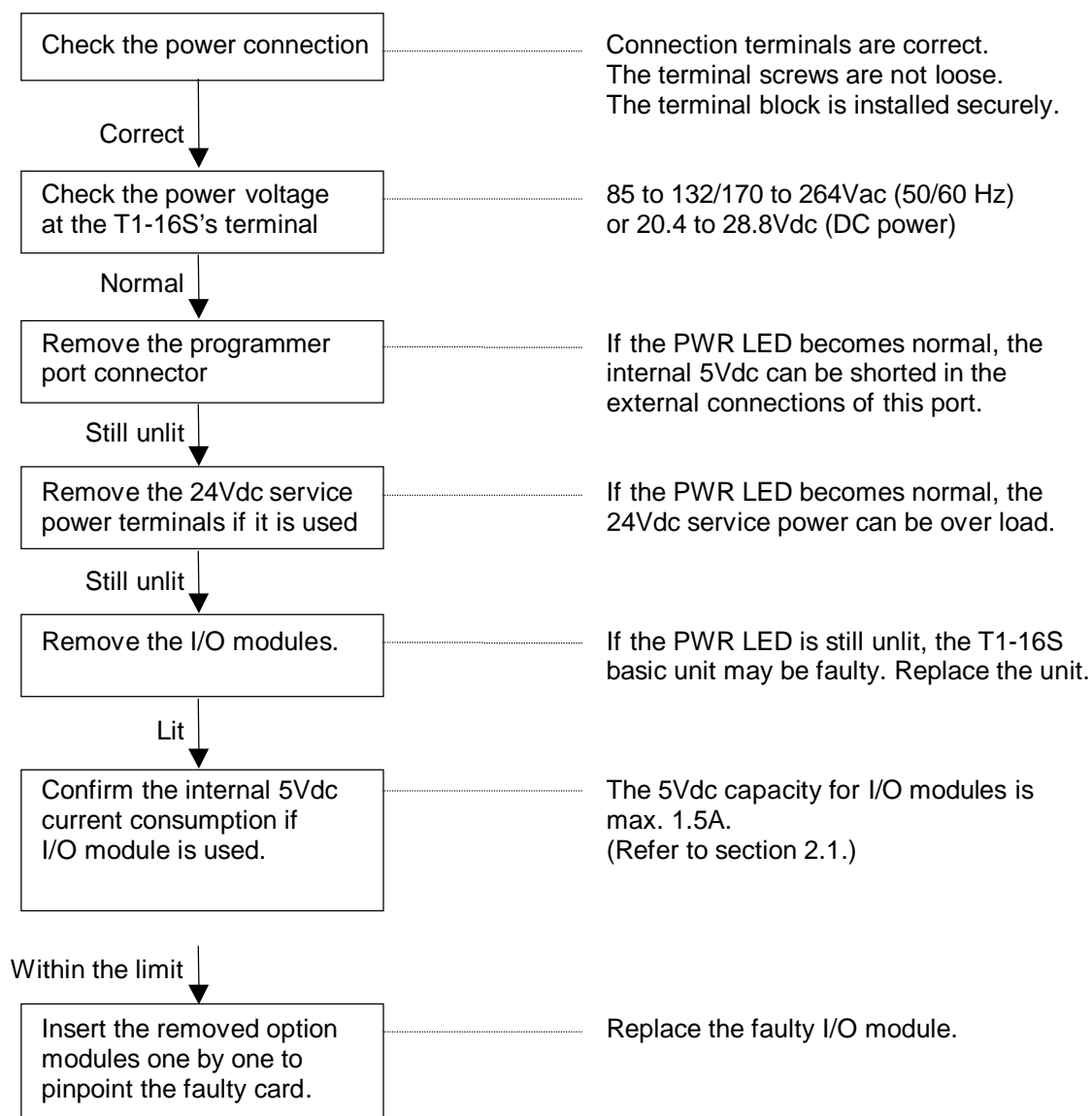

10. Troubleshooting

10.1.2 CPU check

If the PWR (power) LED is lit but the RUN LED is not lit, check the following points.

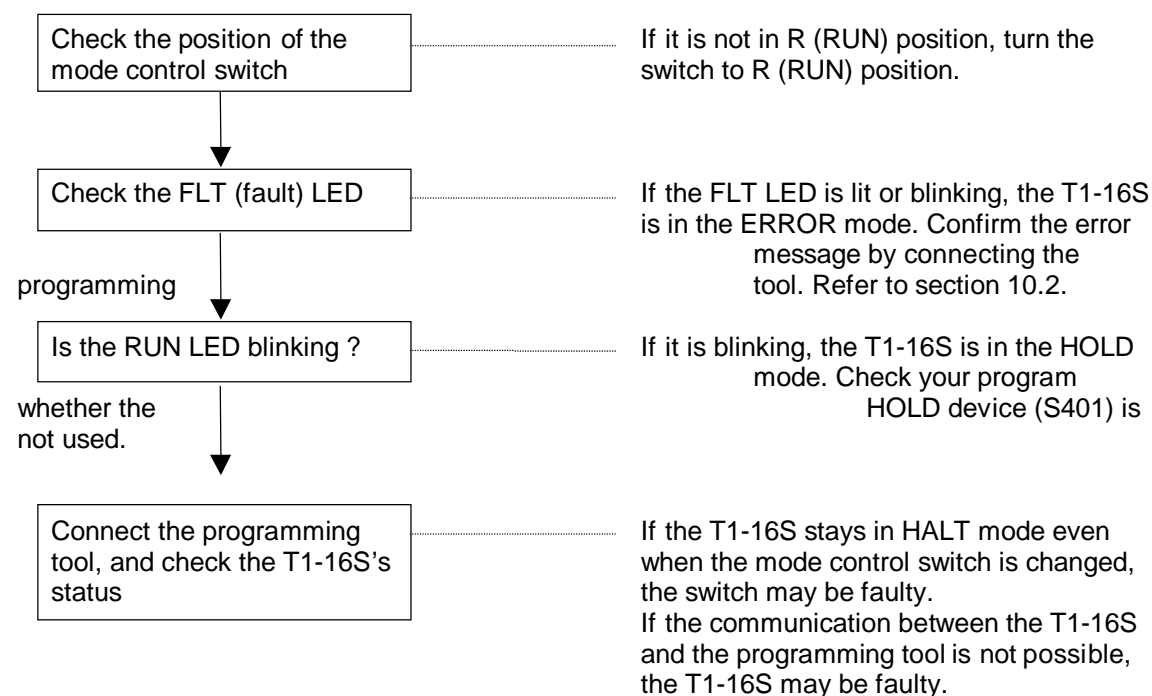

10.1.3 Program check

Check the user program based on the following points if it is running but the operation does not work as intended.

- (1) Whether duplicated coils are not programmed.
- (2) Whether a coil device and a destination of a function instruction are not overlapping.
- (3) Whether the ON/OFF duration of an external input signal is not shorter than the T1-16S's scan time.
- (4) Whether a register/device, which is used in the main program, is not operated erroneously in the interrupt program.



NOTE When you write/modify the program, it is necessary to execute the EEPROM write operation before turning off power to the T1. Otherwise the old program stored in the built-in EEPROM will be over-written, and your program modification will disappear.

10. Troubleshooting

10.1.4 Input check

If the program is running but the external input signal is not read normally, check the following points:

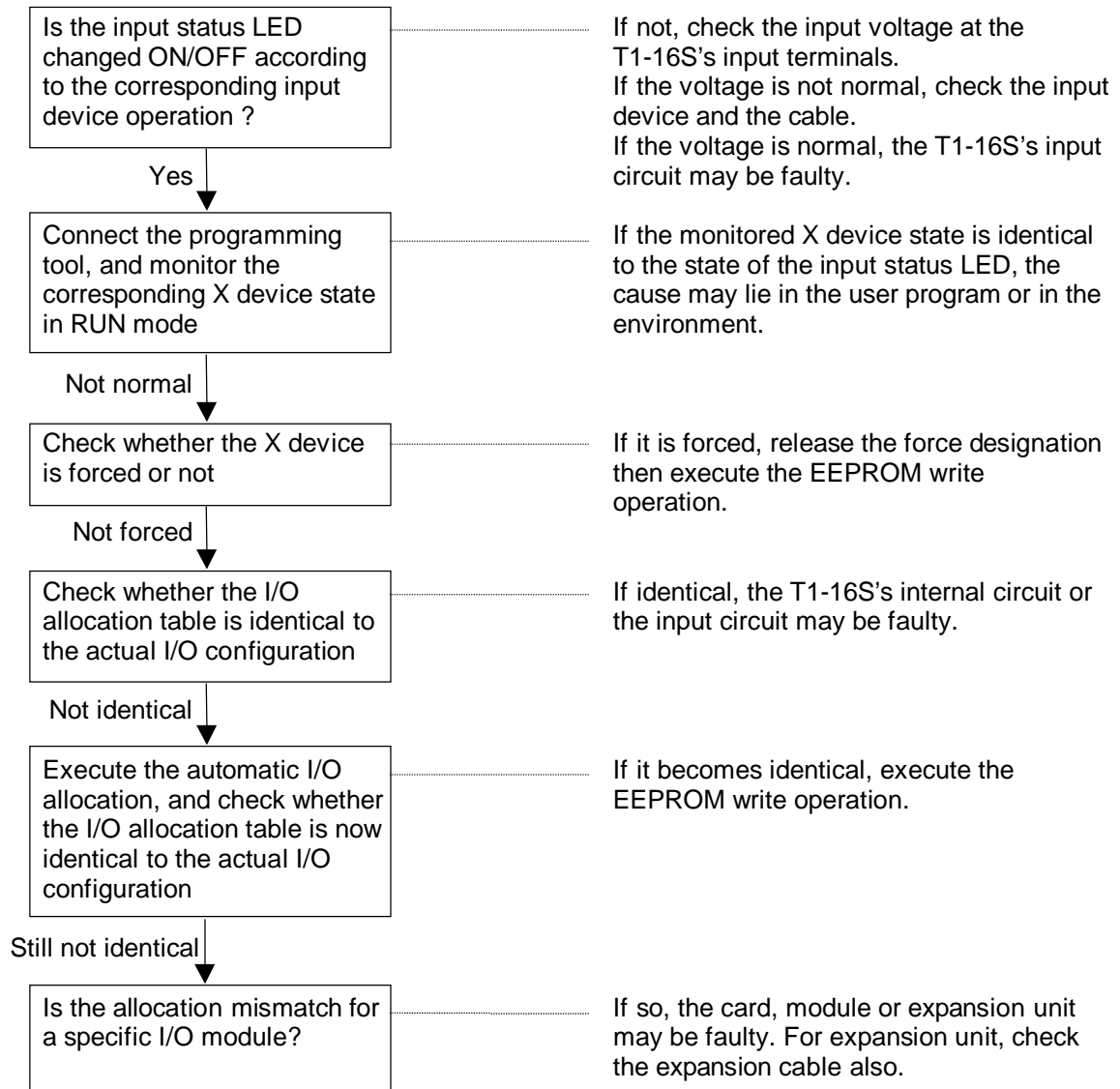

10. Troubleshooting

10.1.5 Output check

If the output status monitored on the programming tool is normal but the external output device (load) is not operated normally, check the following points:

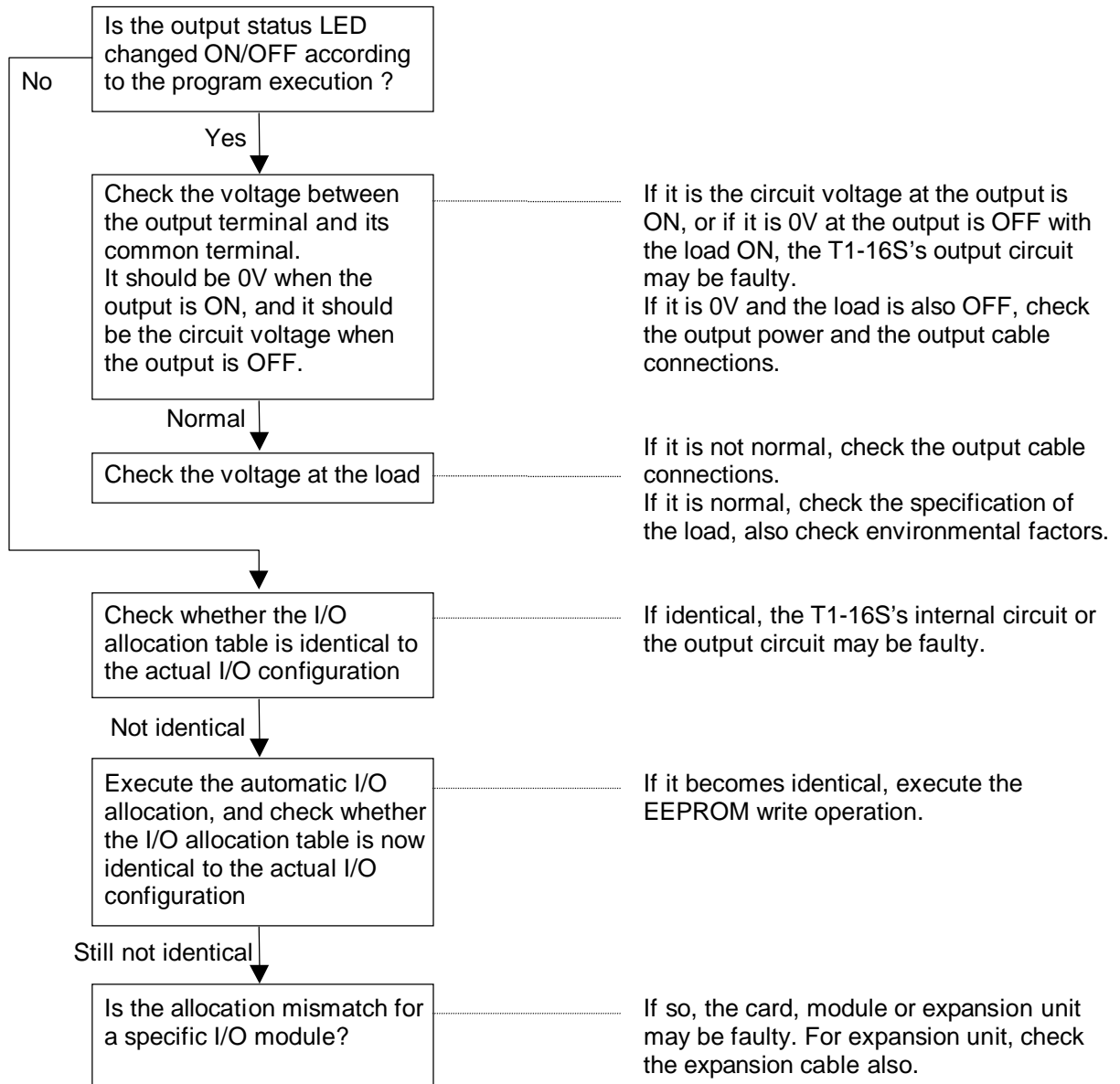

10. Troubleshooting

10.1.6 Environmental problem

If the following improper operations occur in the controlled system, check possible environmental factors.

- (1) If an improper operation occurs synchronously with the operation of I/O devices:
The noise generated at ON/OFF of the output device (load) may be the cause of the problem. Take necessary measures mentioned in section 3.
- (2) If an improper operation occurs synchronously with the operation of surrounding equipment or high-frequency equipment:
The noise induced in I/O signal lines may be the cause of the problem. The surge voltage, voltage fluctuations, or differences of grounding potentials may cause the problem, depending on the power supply system or the grounding system. Check the operation in accordance with the precautions in section 4. For some cases, isolation from the ground may lead to the stable operation.
- (3) If an improper operation occurs synchronously with the operation of machinery:
The vibration of the equipment may cause the problem. Check that the installation status of the units and take necessary measures.
- (4) If a similar failure is repeated after the unit is replaced:
Check that no metal debris or water drops has been entered into the unit/module.

Apart from the above points, consider climatic conditions. If the ambient temperature is beyond the specified range, stable operation of the system is not guaranteed.

10. Troubleshooting

10.2 Self-diagnostic items

If an error is detected by the self-diagnostic check of the T1-16S CPU, the error messages and the related information shown on the following pages will be recorded in the T1-16S's event history table. If the error is severe and continuation of operation is not possible, the T1-16S turns OFF all outputs and stops the operation (ERROR mode).

The latest 15 error messages are stored in the event history table. This event history table can be displayed on the programming tool. (Power ON/OFF is also registered)

If the T1-16S has entered into ERROR mode, connect the programming tool to the T1-16S to confirm the error message in the event history table. This information is important to recover from a trouble. For the key operations on the programming tool to display the event history table, refer to the separate manual for the programming tool.

(An example of the event history)

< Event History >								
	Date	Time	Event	Count	Info 1	Info 2	Info 3	Mode
1.	98-02-21	16:48:01	I/O no answer	3	#00-04			RUN Down
2.	98-02-21	15:55:26	System power on	1				INIT.
3.	98-02-21	12:03:34	System power off	1				RUN
4.	98-01-15	09:27:12	System power on	1				INIT.
5.	98-01-14	19:11:43	System power off	1				HALT
6.	98-01-14	10:39:11	No END/IRET error	3	M-001	H0024		HALT Down
			⋮					

In the event history table, No.1 message indicates the latest event recorded. Each column shows the following information.

Date: The date when the error has detected (Enhanced model only)

Time: The time when the error has detected (Enhanced model only)

Event: Error message

Count: Number of times the error has detected by retry action

Info n: Related information to the error detected

Mode: T1-16S's operation mode in which the error has detected (INIT. means the power-up initialization)

Down: Shows the T1-16S has entered into ERROR mode by the error detected

If the T1-16S is in the ERROR mode, operations to correct the program are not accepted.

In this case, execute the Error reset operation by the programming tool to return the HALT mode before starting the correction operation.

10. Troubleshooting

Error message and related information				Special device	Meaning and countermeasures
Event	Info 1	Info 2	Info 3		
Batt voltage drop				S00F	In the power-up initialization, data invalidity of RAM (back-up area) has been detected. If retentive registers are used, these validity are not guaranteed. (No error down)
Boundary error	Program type - block No.	Address in the block	FUN No.	S064	The register of index modification is other than RW, T, C and D. (Error down) The register designated by index modification has exceeded the allowable range. That is, out of RW, T, C and D. (No error down) Check the value of the index register.
Clock-calendar error				S00A	The data of built-in calendar LSI is illegal. (No error down) Set the date and time. (Enhanced model only)
Duplicate entry No.	Program type - block No.	Address in the block	Entry No.		Multiple SUBR instructions which have the same subroutine number are programmed. (Error down) Check the program.
EEPROM BCC error	Illegal BCC			S004 S013	BCC error has been detected in the user program of the EEPROM. (Error down) Reload the program and execute EEPROM write operation again.
EEPROM warning	Number of excess writing			S007	The number of times of writing into EEPROM has exceeded the life (100,000 times). (No error down) Replace the unit because the data reliability of the EEPROM will decrease.
I/O bus error	Unit No.	Data		S005 S020	An abnormality has been detected in I/O bus checking. (Error down) Check the expansion cable connection and I/O module mounting status.
I/O mismatch	Unit No. - slot No.	Register No.		S005 S021	The I/O allocation information and the actual I/O configuration are not identical. (Error down) Check the I/O allocation and the I/O module mounting status.
I/O no answer	Unit No. - slot No.	Register No.		S005 S022	No response from the T2 I/O module has been received. (Error down) Check the I/O allocation, the expansion cable connection and the T2 I/O module mounting status.
I/O parity error	Unit No. - slot No.	Register No.		S005 S023	I/O bus parity error has been detected in data read/write for T2 I/O modules. (Error down) Check the expansion cable connection and the T2 I/O module mounting status.
Illegal I/O reg	Unit No. - slot No.	Register No.		S005 S021	The allocated I/O register address exceeds the limit, 32 words. (Error down) Check the I/O allocation.

10. Troubleshooting

Error message and related information				Special device	Meaning and countermeasures
Event	Info 1	Info 2	Info 3		
Illegal inst	Program type - block No.	Address in the block		S006 S030 S060	An illegal instruction has been detected in the program. (Error down) Reload the program and execute EEPROM write operation again.
Illegal sys intrpt	Interrupt address 1	Interrupt address 2			Unregistered interrupt has occurred. (No error down) If the error occurs frequently, replace the unit.
Invalid Fun inst	Program type - block No.	Address in the block	Fun No.		A function instruction which is not supported by the T1-16S is programmed. (Error down) Correct the program.
Invalid program	Program type - block No.				A basic ladder instruction which is not supported by the T1-16S is programmed. (Error down) Correct the program. ----- SUBR instruction is not programmed before RET instruction. (Error down) Correct the program. ----- An abnormality is detected in the program management information. (Error down) Reload the program and execute EEPROM write operation again.
Loop nesting error	Program type - block No.	Address in the block			A FOR-NEXT loop is programmed inside other FOR-NEXT loop. (Error down) Correct the program.
Memory full					The program exceeds the executable memory capacity. (Error down) Reduce the program steps.
No END/IRET error	Program type - block No.	Address in the block			The END instruction is not programmed in the main program or in the sub-program. (Error down) Correct the program. ----- The IRET instruction is not programmed in the interrupt program. (Error down) Correct the program.
No RET error	Program type - block No.	Address in the block	Sub-r No.		The RET instruction is not programmed in the subroutine program. (Error down) Correct the program.
No sub-r entry	Program type - block No.	Address in the block	Sub-r No.		The subroutine corresponding to CALL instruction is not programmed. (Error down) Correct the program.

10. Troubleshooting

Error message and related information				Special device	Meaning and countermeasures
Event	Info 1	Info 2	Info 3		
Operand error	Program type - block No.	Address in the block			<p>A register/device which is not supported by the T1-16S is programmed. (Error down) Correct the program.</p> <p>-----</p> <p>The timer or counter register is duplicated in the program. (Error down) Correct the program.</p> <p>-----</p> <p>The subroutine number programmed with CALL or SUBR instruction is out of the range. (Error down) 0 to 255 Correct the program.</p> <p>-----</p> <p>Index modification is programmed for instructions in which the index modification is not allowed. (Error down) Correct the program.</p>
Pair inst error	Program type - block No.	Address in the block			<p>The combination is illegal for MCS-MCR, JCS-JCR or FOR-NEXT instructions. (Error down) Correct the program.</p> <p>-----</p> <p>A MCS-MCR is programmed inside other MCS-MCR segment. (Error down) Correct the program.</p> <p>-----</p> <p>A JCS-JCR is programmed inside other JCS-JCR segment. (Error down) Correct the program.</p>
Peripheral LSI err	Error code			S004 S016	<p>CPU hardware error has been detected in the power-up initialization. (Error down and programming tool cannot be connected) Replace the unit if the error remains after power OFF and ON again.</p>
Program BCC error	Illegal BCC			S006 S030	<p>BCC error has been detected in the user program in the RAM. (Error down) If the error remains after power OFF and ON again, reload the program and execute EEPROM write operation.</p>
RAM check error	Error address	Error data	Test data	S004 S012	<p>In the power-up initialization, an error has been detected by RAM read/write checking. (Error down) Replace the unit if the error remains after power OFF and ON again.</p>
Scan time over	Scan time			S006 S031	<p>The scan time has exceeded 200 ms. (Error down) Correct the program to reduce the scan time or use WDT instruction to extend the check time.</p>

10. Troubleshooting

Error message and related information				Special device	Meaning and countermeasures
Event	Info 1	Info 2	Info 3		
Sys RAM check err	Error address	Error data	Test data	S004 S011	In the power-up initialization, an error has detected by system RAM read/write checking. (Error down and programming tool cannot be connected) Replace the unit if the error remains after power OFF and ON again.
Sys ROM BCC error	Illegal BCC			S004 S010	BCC error has been detected in the system program in the ROM. (Error down and programming tool cannot be connected) Replace the unit if the error remains after power OFF and ON again.
System power off					Power OFF (no error)
System power on					Power ON (no error)
Sub-r nesting err	Program type - block No.	Address in the block	Sub-r No.		The nesting of subroutines exceeds 3 levels. (Error down) Correct the program.
WD timer error	Address 1	Address 2		S004 S01F	The watchdog timer error has occurred. (Error down) If the error occurs frequently, replace the unit.

Appendix

- A.1 List of models and types, 294*
- A.2 Instruction index, 295*

Appendix

A.1 List of models and types

- **Basic unit**

Model	Power supply	Input type	RTC/RS-485	Type code	Part number
T1-16S	100 – 240Vac	24Vdc	Yes	T1-MDR16SS	TDR116S6S
			No	T1-MDR16SC	TDR116S6C
	24Vdc		Yes	T1-MDR16SSD	TDR116S3S
			No	T1-MDR16SCD	TDR116S3C

- **I/O module**

Description	Type code	Part number
16 points 24Vdc input	DI116M	TDI116M*S
16 points 24Vdc output	DO116M	TDO116M*S
8 points 24Vdc input and 8 points 24Vdc output	DD116M	TDD116M*S
8 points relay output	RO108M	TRO108M*S
1 channel analog input, 0 – 5V/0 - 20mA	AD121M	TAD121M*S
1 channel analog input, $\pm 10V$	AD131M	TAD131M*S
1 channel analog output, 0 – 20mA	DA121M	TDA121M*S
1 channel analog output, $\pm 10V$	DA131M	TDA131M*S
1 channel thermo couple input, K/E/J	TC111M	TTC111M*S
TOSLINE-F10 remote station	FR112M	TFR112M*S

- **Peripherals**

Description	Type code	Part number
Handy programmer (with 2 m cable for T1/T1S)	HP911A	THP911A*S
T-PDS software (Windows version)	T-PDS Windows	TMW33E2SS
Program storage module	RM102	TRM102**S
Multi-drop adapter for computer link	CU111	TCU111**S

- **Cable and others**

Description	Type code	Part number
T-PDS cable for T1/T1S, 5m length	CJ105	TCJ105*CS
HP911A cable for T1/T1S, 2m length (spare parts)	CJ102	TCJ102*CS
RS-232C connector for computer link (with 2 m cable)	PT16S	TPT16S*AS
I/O module I/O connector for DI116M/DO116M/DD116M, soldering type	PT15S	TPT15S*AS
I/O module I/O connector for DI116M/DO116M/DD116M, flat cable type	PT15F	TPT15F*AS

Appendix

A.2 Instruction index

- **Instruction name**

1 bit rotate left	173	Exclusive OR	158
1 bit rotate right	172	Expanded data transfer	241
1 bit shift left	165	Flip-flop	215
1 bit shift right	164	FOR	205
2's complement	232	Forced coil	122
7-segment decode	234	Function generator	229
Absolute value	231	Greater than	178
Addition	143	Greater than or equal	179
Addition with carry	149	Hex to ASCII conversion	161
AND	156	Increment	154
ASCII conversion	236	Interrupt return	210
ASCII to Hex conversion	162	Invert coil	124
Average value	228	Invert transfer	138
BCD conversion	238	Inverter	123
Bi-directional shift register	170	Jump control reset	134
Binary conversion	237	Jump control set	134
Bit count	202	Less than	182
Bit test	163	Less than or equal	183
Calendar operation	218	Lower limit	225
Coil	121	Master control reset	133
Counter	132	Master control set	133
Data exchange	139	Maximum value	226
Data transfer	136	Minimum value	227
Decode	201	Moving average	159
Decrement	155	Multiplexer	176
Demultiplexer	177	Multiplication	145
Device/register reset	197	n bit rotate left	175
Device/register set	196	n bit rotate right	174
Digital filter	160	n bit shift left	167
Direct I/O	239	n bit shift right	166
Disable interrupt	209	NC contact	118
Division	146	Negative pulse coil	128
Double-word 2's complement	233	Negative pulse contact	126
Double-word addition	147	NEXT	206
Double-word data transfer	137	NO contact	117
Double-word equal	286	Not equal	181
Double-word greater than	284	OFF delay timer	130
Double-word greater than or equal	285	ON delay timer	129
Double-word less than	288	OR	157
Double-word less than or equal	289	Positive pulse coil	127
Double-word not equal	287	Positive pulse contact	125
Double-word subtraction	148	Pre-derivative real PID	219
Enable interrupt	208	Reset carry	199
Encode	200	Set calendar	217
End	135	Set carry	198
Equal	180	Shift register	168

Appendix

Single shot timer	131
Special module data read	245
Special module data write	247
Step sequence initialize	212
Step sequence input	213
Step sequence output	214
Subroutine call	203
Subroutine entry	207
Subroutine return	204
Subtraction	144
Subtraction with carry	150
Table initialize	140
Table invert transfer	142
Table transfer	141
Transitional contact (falling)	120
Transitional contact (rising)	119
Unsigned division	152
Unsigned double/single division	153
Unsigned equal	192
Unsigned greater than	190
Unsigned greater than or equal	191
Unsigned less than	194
Unsigned less than or equal	195
Unsigned multiplication	151
Unsigned not equal	193
Up-down counter	216
Upper limit	224
Watchdog timer reset	211

Appendix

• Instruction symbol

*	145	FG	229	U/D	216
+	143	FOR	205	U<	194
+1	154	HTOA	161	U<=	195
+C	149	I/O	239	U<>	193
-	144	IRET	210	U=	192
-1	155	JCR	134	U>	190
-C	150	JCS	134	U>=	191
/	146	LL	225	UL	224
<	182	MAVE	159	WDT	211
<=	183	MAX	226	WRITE	247
<>	181	MCR	133	XCHG	139
=	180	MCS	133	XFER	241
>	178	MIN	227		
>=	179	MOV	136		
7SEG	234	MPX	176		
ABS	231	NEG	232		
AND	156	NEXT	206		
ASC	236	NOT	138		
ATOH	162	OR	157		
AVE	228	PID3	219		
BC	202	READ	245		
BCD	238	RET	204		
BIN	237	RST	197		
CALL	203	RSTC	199		
CLDN	217	RTL	175		
CLDS	218	RTL1	173		
CNT	132	RTR	174		
D+	147	RTR1	172		
D-	148	SET	196		
D<	188	SETC	198		
D<=	189	SHL	167		
D<>	187	SHL1	165		
D=	186	SHR	166		
D>	184	SHR1	164		
D>=	185	SR	168		
DEC	201	SS	131		
DFL	160	STIN	213		
DI	209	STIZ	212		
DIV	153	STOT	214		
DMOV	137	SUBR	207		
DNEG	233	TEST	163		
DPX	177	TINZ	140		
DSR	170	TMOV	141		
EI	208	TNOT	142		
ENC	200	TOF	130		
END	135	TON	129		
EOR	158	U*	151		
F/F	215	U/	152		

TOSHIBA

TOSHIBA CORPORATION
Industrial Equipment Department

1-1, Shibaura 1-chome, Minato-ku

Tokyo 105-8001, JAPAN

Tel: 03-3457-4900 Fax: 03-5444-9268